

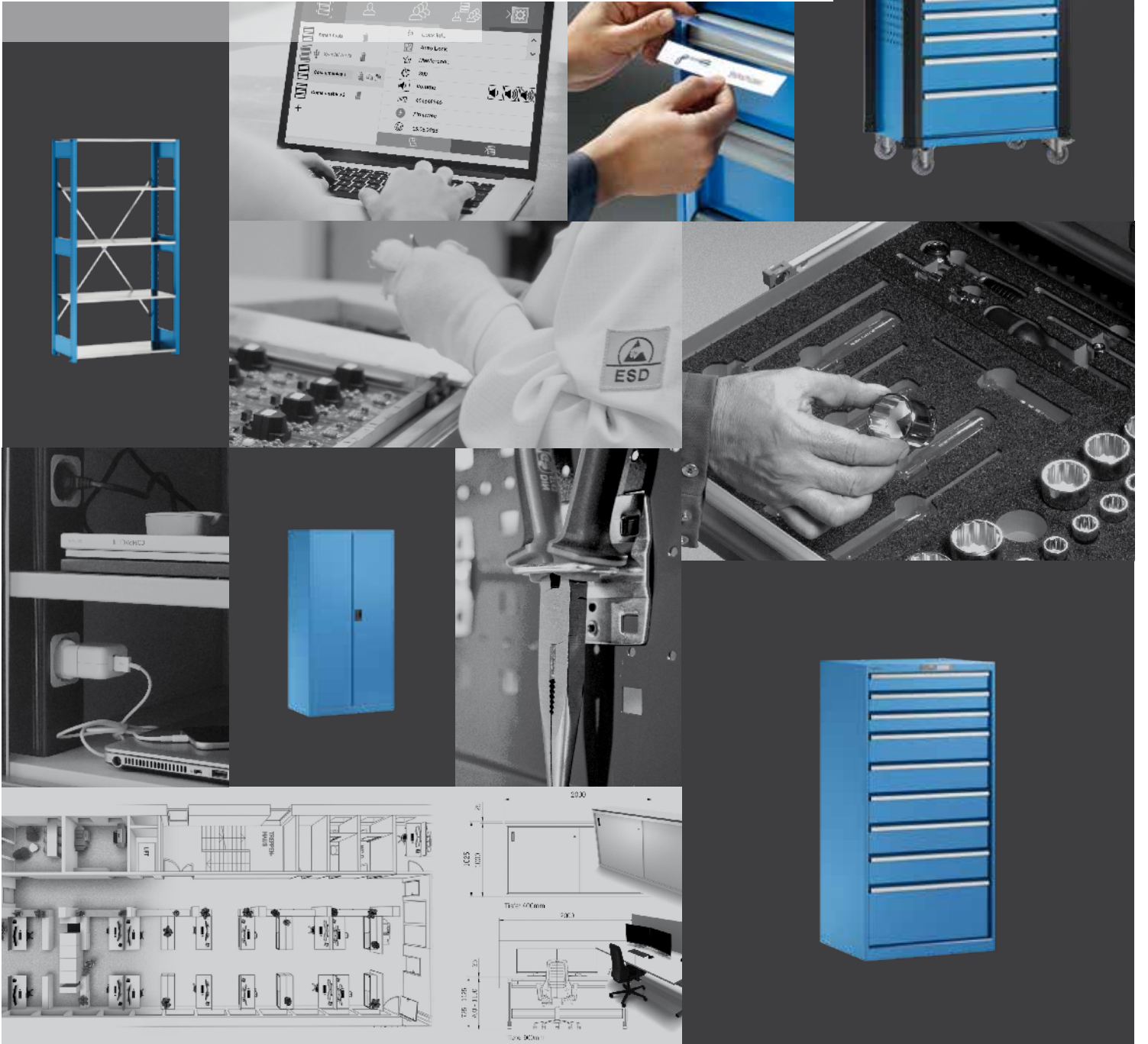

# LISTA CATALOGUE

WORKSPACE AND STORAGE EQUIPMENT



# LISTA AS A PARTNER

LISTA offers organisation. With success, experience and a systemic approach. For more than 75 years, we have offered our customers concepts for more organised and efficient working. Because we offer more than just a high-quality product, competent advice and









a wide range of services: the LISTA system creates perfect interlocking solutions for smooth work processes. And this makes us a leading partner in the area of workspace and storage equipment worldwide.



## BENEFITS AT A GLANCE

- + Comprehensive range**  
from A for access control to W for workstation systems
- + Modular system**  
all products can be freely combined
- + Maximum flexibility**  
with a choice of colours, configuration options and more
- + Tailor-made solutions**  
for customers with specific needs
- + Expert planning**  
including visualisation with LISTA Draw
- + 10-year guarantee**  
unique in the industry
- + Wide range of services**  
such as training, assembly, labelling etc.
- + Worldwide distribution and service network**  
for customer service without borders
- + First-class references**  
from more than 100,000 prestigious companies worldwide

# THE LISTA PROGRAMME

	Profile on LISTA	04
	Features and special characteristics	22
	Drawer cabinets	38
	Workshop trolley	80
	Drawer storage walls	84
	NC storage and transport systems	100
	Workstation systems and workbenches	106
	Cabinet systems	168
	Shelving systems	218
	Partition material and labelling system	248
	Order/Contact partners / Colours	270

# WELCOME TO THE NO. 1

As varied as your challenges in modern storage and workspace equipment are, so too are the industries we provide with suitable solutions. Bet that your business is also on our customer list?

This gives you the certainty that we are experts and know how different the requirements are in the different areas.

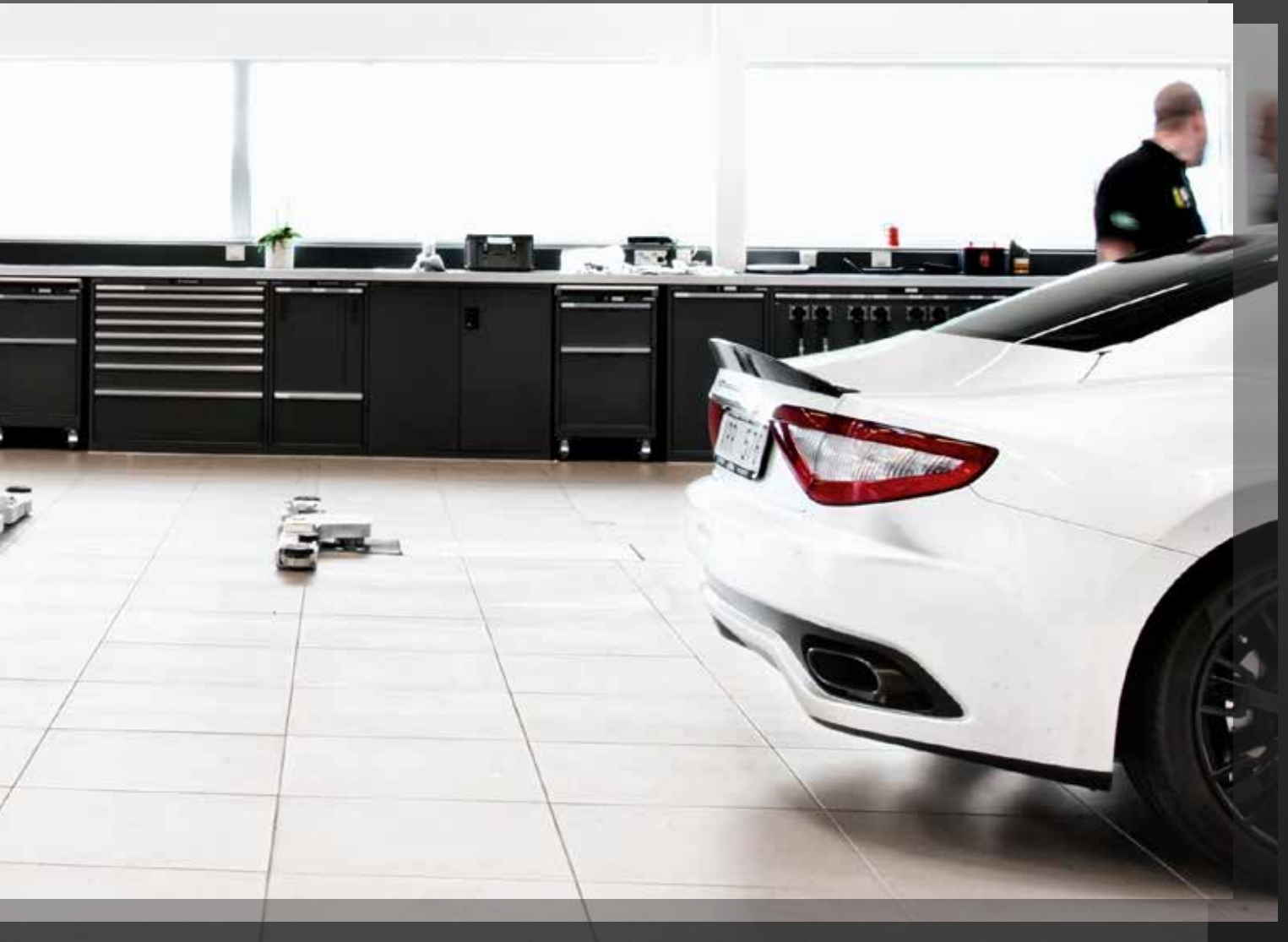

Automotive



Banking and administration



Careers, education and leisure



Fire brigades and police



Healthcare



Aviation



Mechanical engineering



Metalworking



Motor sport



Museums



Public transport



Schools and universities



Watches, jewellery, coins



Maintenance and repair



Defence and security



Tool manufacturers

# SYSTEMATIC WORK

The system-based approach is a LISTA trademark. To help you set up your business in the best way possible, we offer you a comprehensive range for all functional areas. Combine individual modules freely as required, from the warehouse, workshop, production and assembly to the office.

Yet the LISTA system cannot only fit in any space. Our products can be individually configured, equipped with matching doors, countertops, variable interior layouts and accessories. And if this still does not lead to the optimal solution, our engineers will develop a special solution for you.

In this way, the LISTA system combines a consistent look and feel with individual functionality, thereby creating the basis for efficient processes in your company. In other words, LISTA allows you to work faster, more productively or simply better.

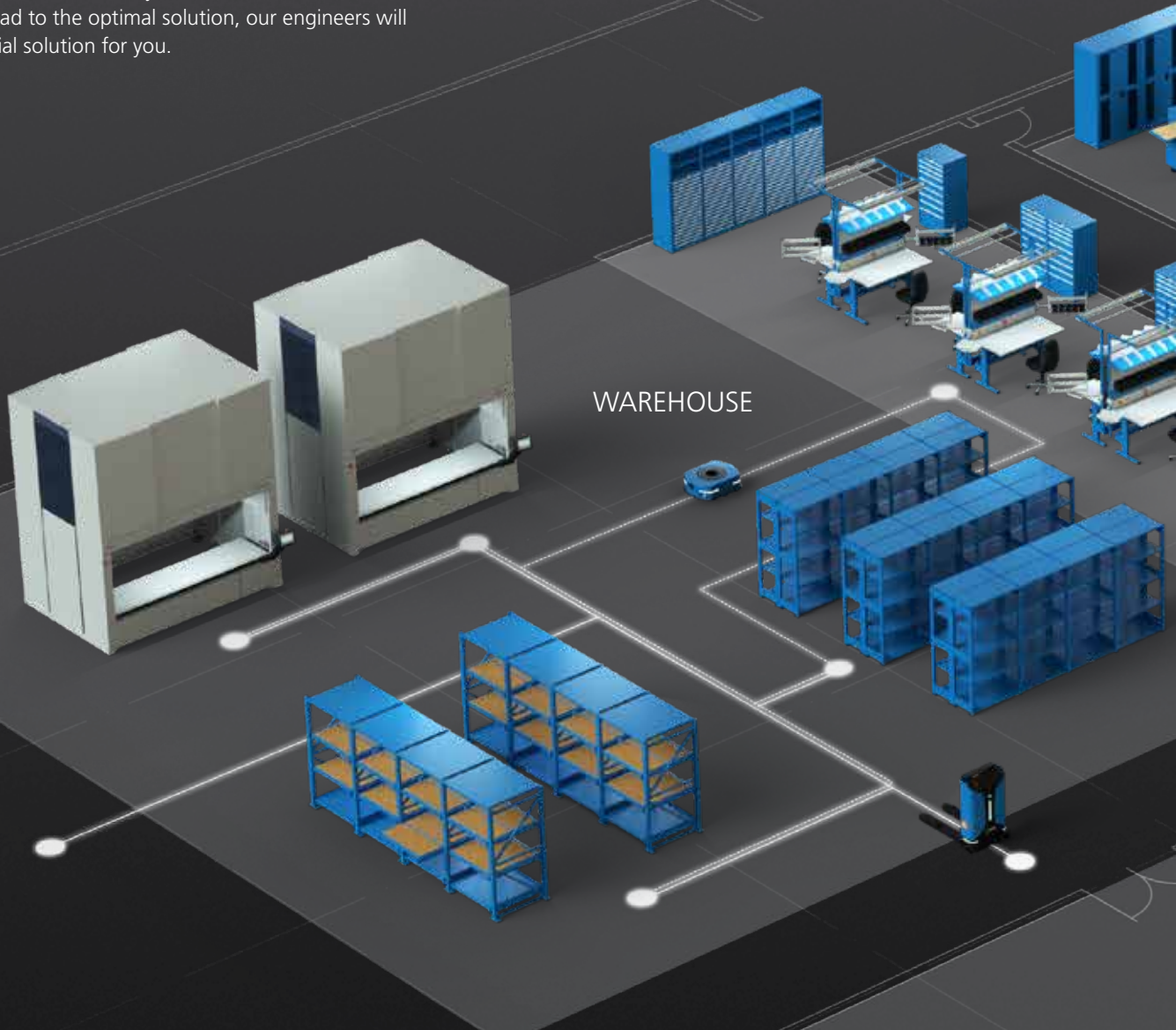

## OPTIMUM MATERIAL FLOW

In addition to ergonomic workplace design and storage, the fast and easy transport of goods and material is a decisive criterion for efficiency and productivity in a company. LISTA solutions ensure a smooth material flow and thus make a valuable contribution to further optimising your intralogistics. More on this starting on page 36.



WORKSHOP

OFFICE

INSTALLATION

RECREATION ROOM

PRODUCTION

**STANDARD PRODUCTS**

- pre-configured for you

**SYSTEM SOLUTIONS**

- individually configurable products
- separate components
- accessories

**SPECIAL SOLUTIONS**

- individual engineering
- industry-specific solutions

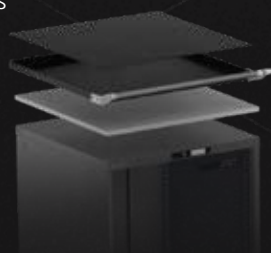

# LISTA SYSTEM SOLUTIONS AT A GLANCE

The working world is becoming more varied. So it is quite fitting that LISTA system solutions can be used to design working environments flexibly and according to requirements. The indivi-

dual modules are available in different versions and offer numerous options for individual configuration. After all, we don't want to sell you just anything, but always the solution that suits you.

## DRAWER CABINET

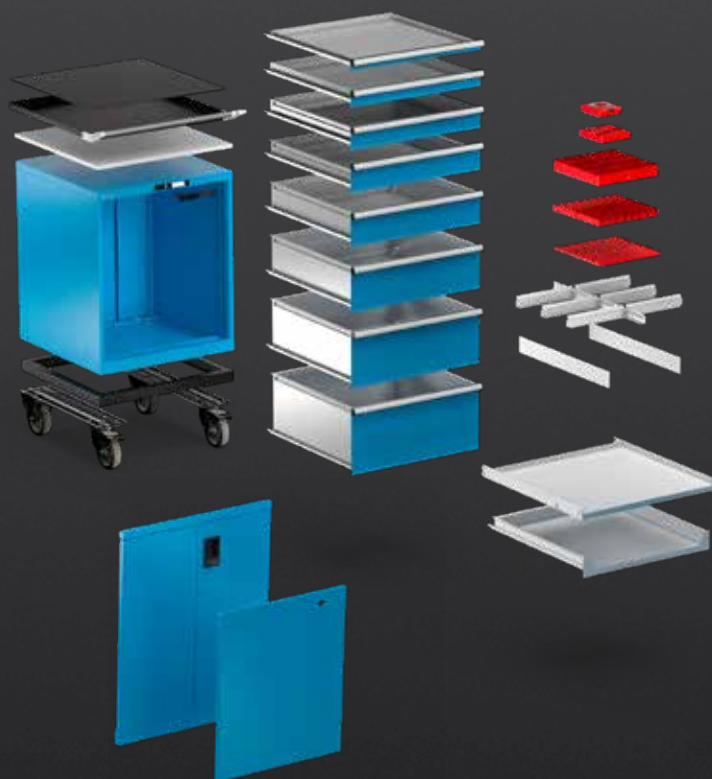

## WORKSTATION

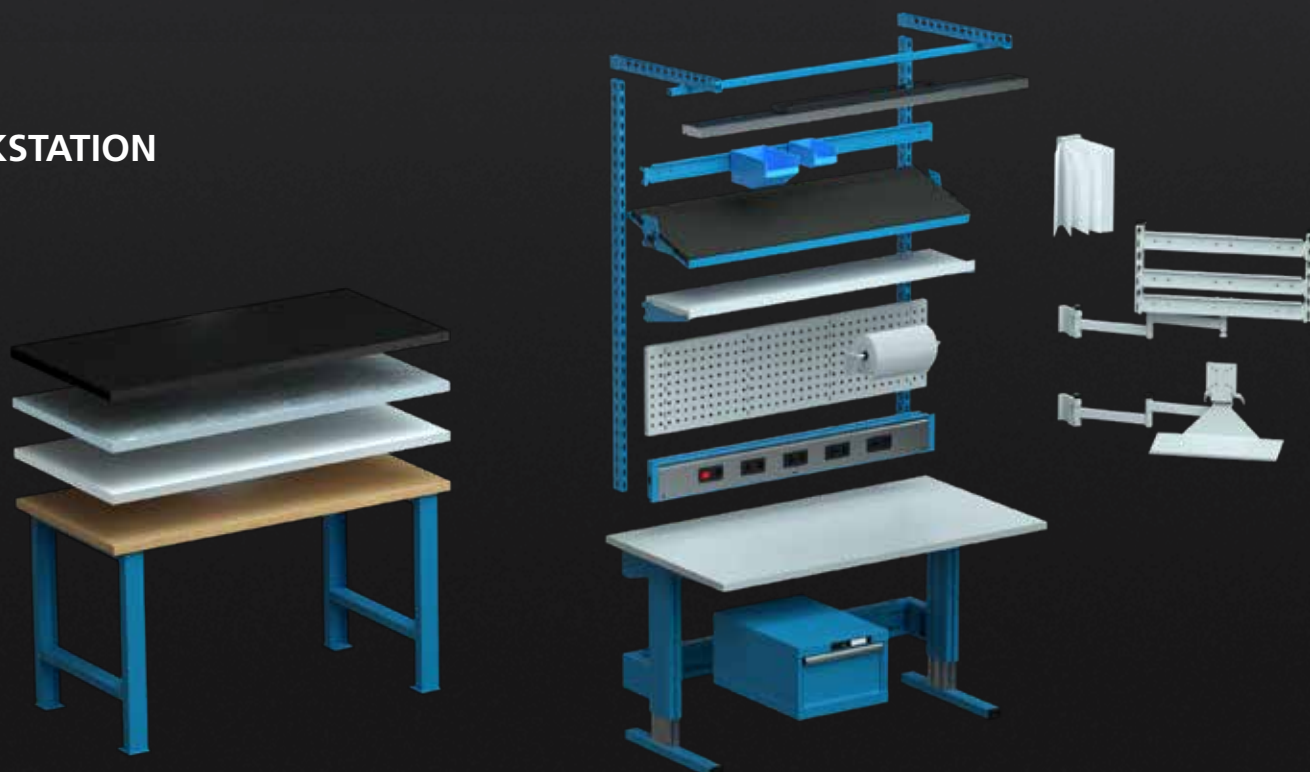





# OPTIMISE YOUR WORKSPACE WITH LISTA

From the favourite colour to the perfect drawer partition: delivering the best product for you is important to us. That's why LISTA offers you free choice in almost all areas. Our surfaces, for example, are available as an ESD version or with an antibacterial coating in addition to the individual colour preference. You will

also receive multi-level locking solutions, up to fully automatic access control, as required. Not to mention comprehensive partition material, accessories and, last but not least, attractive extras such as our EDGE design cabinet.

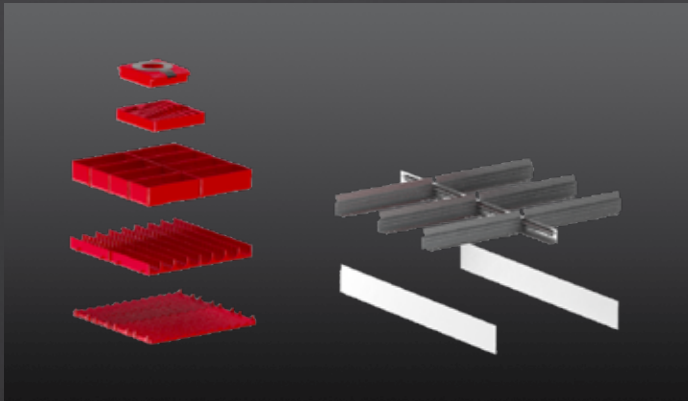

## Comprehensive partition material

Plastic boxes, troughs, anti-slide mats, dividers and more: the right partition material brings order to your LISTA drawers and also ensures more efficient workflows and increased productivity. See p. 248.

## Smart accessories

Accessories such as hooks, lights or desk chairs complete your LISTA system. Design each workstation ergonomically and precisely to suit your individual requirements. See p. 162.



## Free choice of colours

Twelve standard colours, six colour combinations, all other colours available. LISTA also provides you with the exact visual solution that suits you. Discover the possibilities. See p. 22.

## Variable locking systems

LISTA provides you with the optimum locking system for your requirements, from standard locking systems with replaceable cylinders to fully electronic control systems. See p. 28.

You can also find further information in our LOCKING SYSTEMS brochure.



### Electronic access control

With our electronically controlled access system LISTA E-Control, you can protect valuable and important stored goods particularly securely and efficiently. See p. 32.

For more information, see our ACCESS CONTROL SYSTEMS brochure.

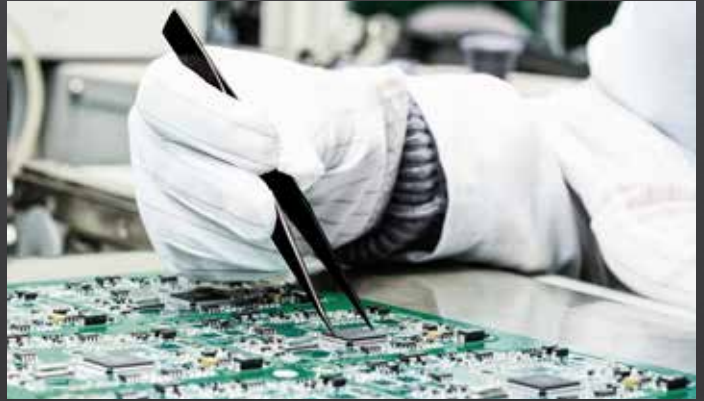

### ESD solutions

Your LISTA workspace equipment is also available as an ESD version to protect sensitive components from electrostatic discharge. See p. 24.

Further information can be found in our ESD SOLUTIONS brochure.



### Antibacterial surface

Infection control included: LISTA solutions are also available with an antibacterial surface coating for medical areas and others requiring increased hygiene.

More information can be found in our HEALTHCARE SOLUTIONS brochure.



### EDGE statement light

EDGE, the LISTA designer cabinet with LED light signature, shines your workspace in a new light. Exciting. Different. State-of-the-art. See p. 34.

Further information can be found in our EDGE brochure.

# THE LISTA PROMISE

Actually, it is very simple: we want you to be satisfied with your LISTA solution. That's why we focus on you as a customer in everything we do. For our products, this means: we manufacture in first-class quality with a long-term guarantee and responsibility

for the future. In this way, you can be sure that LISTA will not only provide you with a high-quality and durable solution, but also a sustainably produced solution.



## TOP INDUSTRIAL QUALITY

LISTA products meet the very highest standards of quality. They are robust, made of top-quality materials and manufactured with first-class workmanship. That is why we offer a 10-year guarantee for our products. This is unique in the industry, but that's not all that LISTA customers can rely on. LISTA solutions have been awarded myriad international certifications, so they can be used worldwide. What's more, they'll still be in use years and decades from now: in addition to the very best industrial quality, we also guarantee subsequent deliveries of your product over a long period of time.



## THE HIGHEST MANUFACTURING STANDARDS

We aim to provide the LISTA system with a consistently high level of quality. We therefore manufacture our products exclusively in Switzerland and Germany. State-of-the-art manufacturing technology and ongoing investment and innovation in our production processes ensure superb results. This has made LISTA a byword for reliability and security as a partner for storage and operating equipment for over 75 years.



## QUALITY MANAGEMENT

We set ourselves realistic goals and review them on an ongoing basis in order to be able to improve our competitiveness and performance in a sustainable way, and thereby increase customer satisfaction. Our quality and environmental management system meets all of the requirements of the international ISO 9001:2015 and ISO 14001:2015 standards. As far as we are concerned, quality begins with our workforce, so we also have ISO 45001:2018 certification.





## ENVIRONMENTAL PROTECTION

Environmental protection is an integral part of our corporate culture. We are committed to sustainable climate protection out of genuine conviction. By voluntarily participating in the Energy Agency for Business scheme, LISTA is committed to actively reducing CO<sub>2</sub> emissions and optimising energy efficiency.



## SUSTAINABILITY

Environmental awareness and sustainability are integrated right from the very development of our products and carried across into all of the subsequent processes. This runs all the way through, from the procurement of raw materials to production and distribution, and finally the long-term use of our cabinets, shelving and other solutions. One reason why we are able to do this is that we mainly use steel as a material. In addition to robustness and durability, the fact that steel can be 100 per cent recycled is another convincing argument in favour of its use.



# SERVICE FROM A SINGLE SOURCE

You can order your LISTA product quickly and easily from the catalogue or configure it online. And it's just as easy if you have any questions or need technical support. Contact LISTA

Service and you will also receive a tailor-made solution from consultation to customer service. Training included.

All contact addresses can be found on p. 270 and online at:  
About LISTA > Contact





## ADVICE, PLANNING AND VISUALISATION

Is your project bigger and more extensive? Then we will be happy to advise you personally, work with you to analyse your individual needs and visualise your new furniture system with the aid of our planning software.



## INDIVIDUAL ENGINEERING

Do you have any special requirements for your operating equipment? Do you require special technical features, special sizes or a company-specific design? If so, we're happy to help by offering our individual engineering service. You can rely on our many years of experience in planning, manufacturing and assembling customer-specific solutions. Even complex projects and ambitious tasks are in the best hands with LISTA.



## INSTALLATION

Your LISTA solution is assembled by skilled technicians. They install the system on site and can also train your employees if necessary. This ensures that the equipment can be put into operation smoothly and also guarantees the successful use of our products over the long term.



## AFTER SALES

After installation and setup, our experienced staff are available to help you with advice and assistance at any time.



## SPARE PARTS

You can obtain the right replacement parts in original LISTA quality for each of our products.



## CUSTOMER SERVICE

For technical queries, simply get in touch with our customer service team. They will provide expert advice and can also come to you if necessary.



## REPAIRS

Do you need a LISTA product to be repaired? Our experts will ensure that your solution is working again as quickly as possible, as you can expect from LISTA.

LISTA After Sales can best be reached via the contact form on the Internet at: [Services > After Sales](#)



## TRAINING

Whether you need to know more about products or customer applications, general background information or practical assembly instructions, at the LISTA Workspace Academy we offer specialist training on the topics that really interest you.

Course overview and registration can be found online: [www.lista-academy.com](http://www.lista-academy.com)

# REFERENCES

With LISTA you are in good company. More than 100 000 prestigious companies around the world trust our solutions. Covering a cross-section of industries and sizes, from ABB to the Zurich

University of Applied Sciences. Take a look at our customer list. And if you want to be included: just contact us and ask.

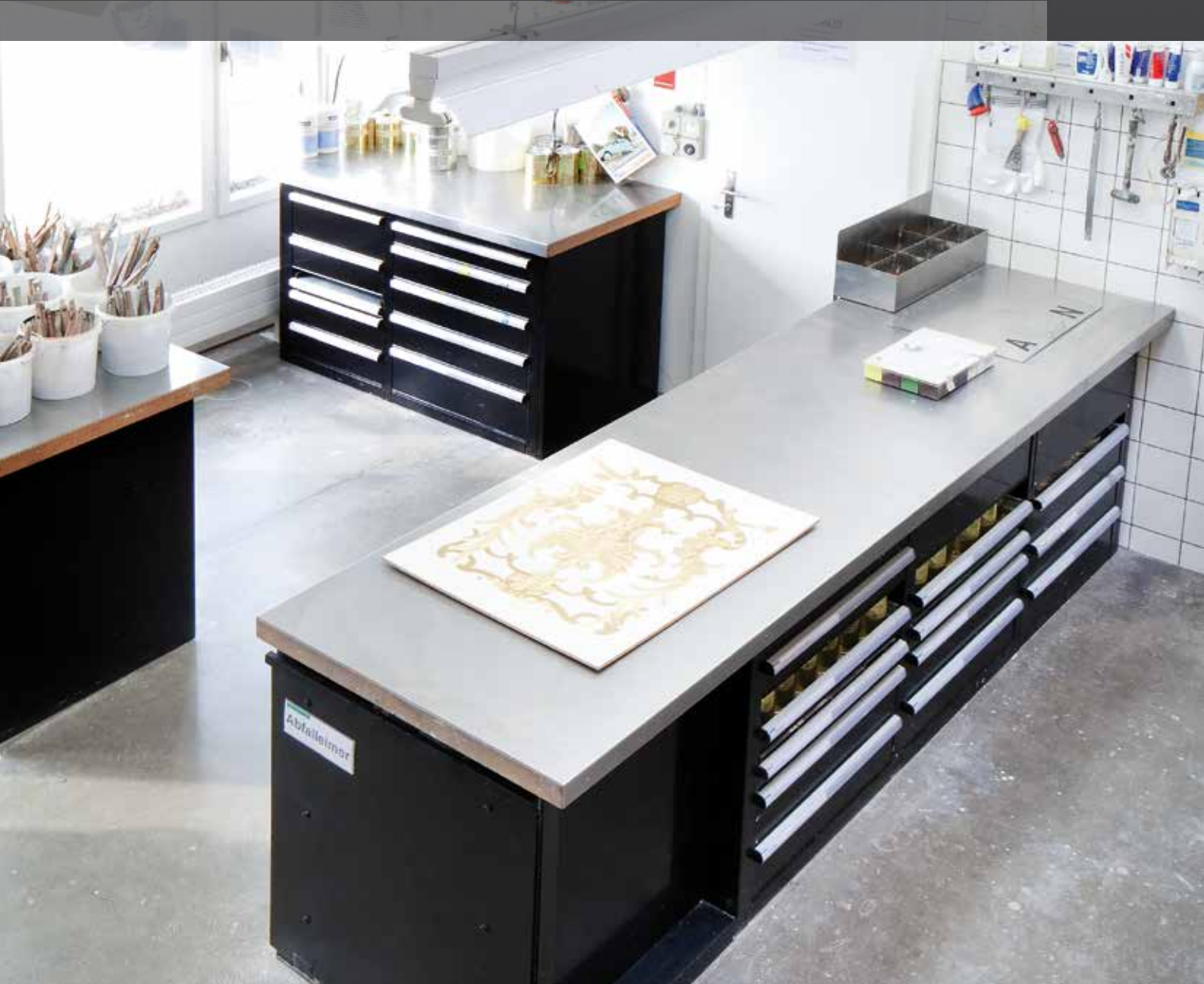





## Automotive

Audi, BMW, Bugatti, Chrysler, Citroën, Continental, Daimler, Dallara, Ferrari, Ford, Lamborghini, Magna, MAN, Maserati, McLaren, Mercedes-Benz, Opel, Peugeot, Porsche, Renault, Rolls-Royce, Toyota, Volvo, VW

## Banking and administration

Credit Suisse, Deutsche Bank, ÖNB, PWC Sanitas, UBS

## Careers, education and leisure

BFI Vocational Training Centre Steiermark, HBLA for Forestry Management, OTT-Jakob Spanntechnik, swimming pools and sports grounds, Waldrich Coburg

## Fire brigades and police

Professional fire brigade, fireproofing service, voluntary fire brigade

## Healthcare

Baxter, Bayer, Berlin-Chemie, Biotronik, Caritas, German Red Cross, Evonik Industries, Klosterfrau Healthcare Group, Merck, Novartis, Rega, Roche, Spitex, Synthes, Takeda







## Aviation

Airberlin, Airbus, Air France, Austrian, Eurocopter, KLM, Lufthansa, MTU Aero Engines, Qatar Airways, Rega, Singapore Airlines, Swiss

## Mechanical engineering

ABB, Benteler Automotive, Bühler, Getrag, Heidelberg, Schaeffler Group, Siemens, ThyssenKrupp

## Metalworking

Cameron, Danieli, Georg Fischer, Hein & Oetting, Feinwerktechnik Oerlikon, ThyssenKrupp

## Motor sport

Sauber F1, McLaren F1, Ferrari F1, Red Bull F1

## Museums

Birmingham Museums and Art Gallery, British Museum, Christie's Education, Vienna Museum of Art History, Muséum National d'Histoire Naturelle, Museum of London, Stiftung Stadtmuseum Berlin, Verkehrshaus der Schweiz







## Public transport

Alstom, BUG Verkehrsbau AG, DB, KCRC Hong Kong, RATP Paris, SBB, Stadler Rail, VBZ Zurich

## Schools and universities

ETH, University of Cambridge, University of Manchester, Hochschule der Künste, Hochschule Rapperswil, RWTH Aachen, Zurich University of Applied Sciences

## Watches, jewellery, coins

Cartier, Chopard Genève, Glashütte, IWC, Louis Vuitton, Patek Philippe Genève, Pro Aurum, Richemont, Rolex, Swarovski, Swatch

## Maintenance and repair

AMAG, Galliker, auto workshops, PSA Group, Porsche, Re Steel



## Defence and security

Alenia Aermacchi, Austrian Federal Army, German Federal Army, Eurocopter, Forsvaret, Dutch Royal Air Force, Krauss Maffei, Rheinmetall, RUAG, U.S.

## Tool manufacturers

BOSCH, D'Andrea, Fehlmann, Gerardi, Hella, Hilti, Kintek, Leitz, Precitool, Sandvik, SECO, Stahlwille, Stihl, Walter





Free choice of colours

## COLOUR YOUR WORKSPACE

The LISTA storage and workspace equipment is available in twelve standard colours, twelve further predefined colour variants and, on request, in any colour and colour combination. This allows you to design each workstation completely flexibly and individually. Different colours for different work areas, coloured accents to increase clarity or complete company facilities in the corporate design: it's all possible. You can find an overview of our colours and colour codes on the fold-out pages at the end.

## YOU SET THE TREND

Do you have a special colour preference? No problem: LISTA solutions are available in any trend colour of your choice. Here are some examples that we have implemented for our customers:



### Standard colours

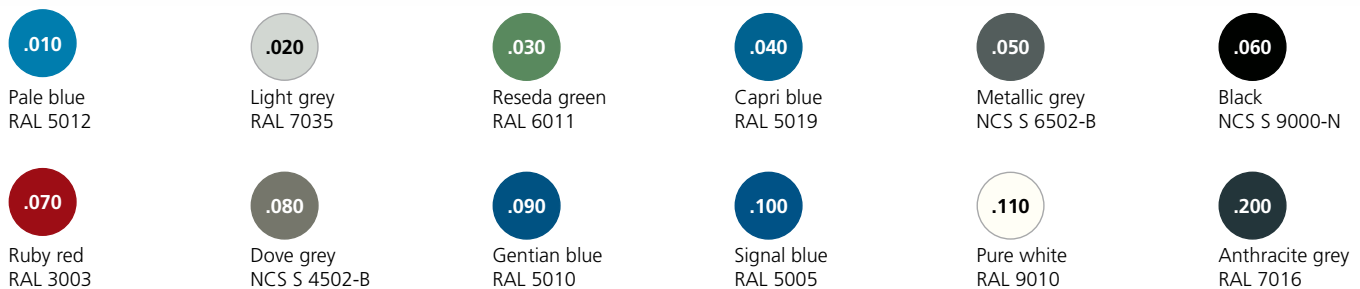

### An additional 12 predefined colours\*

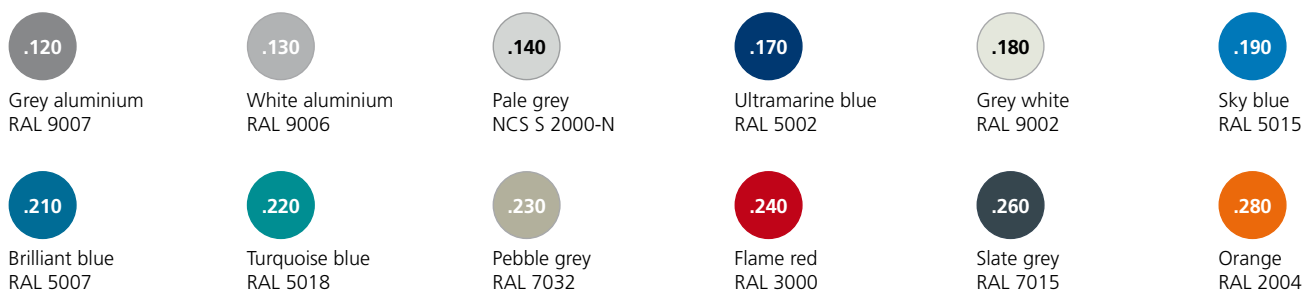

\*12 other predefined colours are available at extra cost.

ESD solutions

# SAFE HANDLING OF ELECTRONIC COMPONENTS

**ESD stands for electrostatic discharge.** It occurs when two objects at different potentials come into direct contact with each other. In modern workplaces, an electrostatic charge can give rise to high voltages depending on the humidity level.

## + Safety for your electronic components

Controlled dissipation of electrostatic charges

## + Comprehensive range of ESD products

for all applications (minimum to full protection)

## + Safe and neat storage

of your electronic components

## + Cost reduction

No damage and latent faults on PCBs

## + Expert planning

of ESD workstations and workspace equipment





## WHEN IS ESD DANGEROUS OR HARMFUL?

It often goes unnoticed by people due to its low energy. However, even very small electrical discharges can quickly damage electronic components or lead to a hidden defect. If damage caused by ESD is noticed too late, high repair or replacement costs can result. Worse than the financial damage is the additional subsequent damage to reputation if, for example, a complete product batch is affected, which can, in turn, lead to a loss of customers.

The general rule therefore is:

**“Where there is no charge, there is no discharge.”**

ESD-safe equipment for handling ESD-sensitive components reduces the risk of static discharge to a minimum. This requires a comprehensive protection concept.



**Warning symbol for ESD-sensitive components.**



**ESD protection components**

## THE COMPREHENSIVE ESD WORK PROGRAMME FROM LISTA

In order to avoid high costs, LISTA offers a complete ESD planning and implementation service – from advice to installation. LISTA has combined years of experience in workstation development with a sound knowledge of ESD problems and developed a comprehensive ESD workstation programme: **all painted surfaces feature a colour coating designed by LISTA that dissipates charges and prevents electrostatic discharge.**



### **IMPORTANT!**

All ESD protection zones must be checked regularly!

## CONFIGURE AND ORDER ESD ZONES INDIVIDUALLY

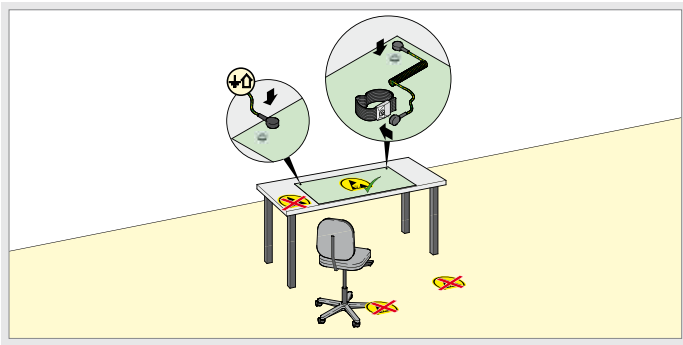

**A** Version A

### Minimum ESD protection

- Dissipative table mat with wrist strap

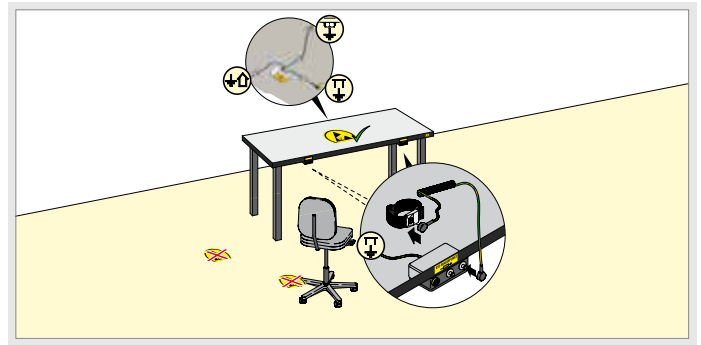

**B** Version B

### Standard ESD protection

- Dissipative table top with wrist strap

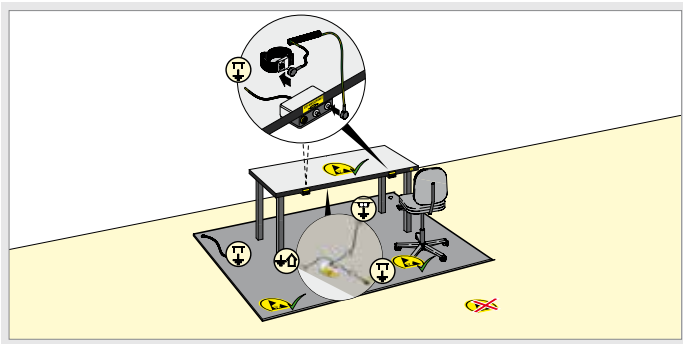

**C** Version C

### ESD isolated solution

- Dissipative table top with wrist strap
- Dissipative desk chair
- Dissipative floor mat

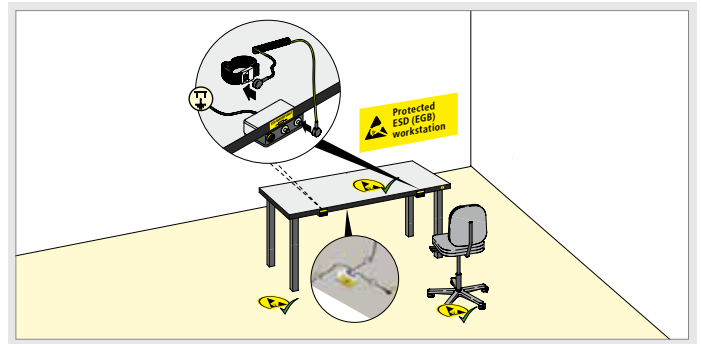

**D** Version D

### ESD protection zone

- Dissipative table top with wrist strap
- Dissipative desk chair
- Dissipative base plate

## A COMPREHENSIVE ESD PROTECTION ZONE INCLUDES THE FOLLOWING AREAS:



### Workstations

The perfect ESD workstation is ergonomically adaptable and ESD protected. Electrostatic charges are dissipated in a controlled manner via the working surface and grounding cable so that the workstation stays charge-neutral.



### Personnel grounding

People are a primary source of electrostatic charges. Wrist strap with grounding cable and shoes are therefore recommended for people working in an electronics manufacturing environment. Desk chairs or stand-up seats should also have ESD protection.



### Storage

Electronic components are best stored in closed ESD drawers or hinged-door cabinets as well as ESD shelving (Faraday cage) with appropriate ESD containers.



### Markings

ESD-protected areas must be marked. Signs or additional labels should be used to warn of ESD-sensitive components.

» see ESD catalogue

## HOW ARE COMPANIES AFFECTED BY ESD?

“They work on components without knowing whether or not these components can be damaged during production.”  
 Checklist for the equipment and maintenance of ESD protection zones to comply with the following ESD basic principles:  
 “Where there is no charge, there is no discharge.”

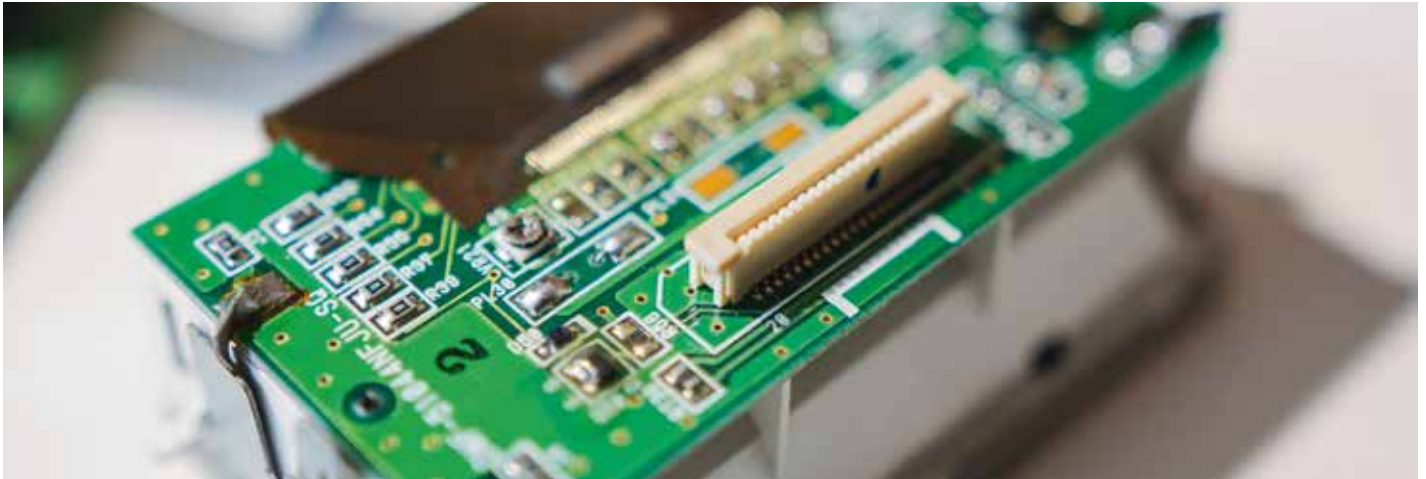

## ESD CHECKLIST FOR COMPANIES

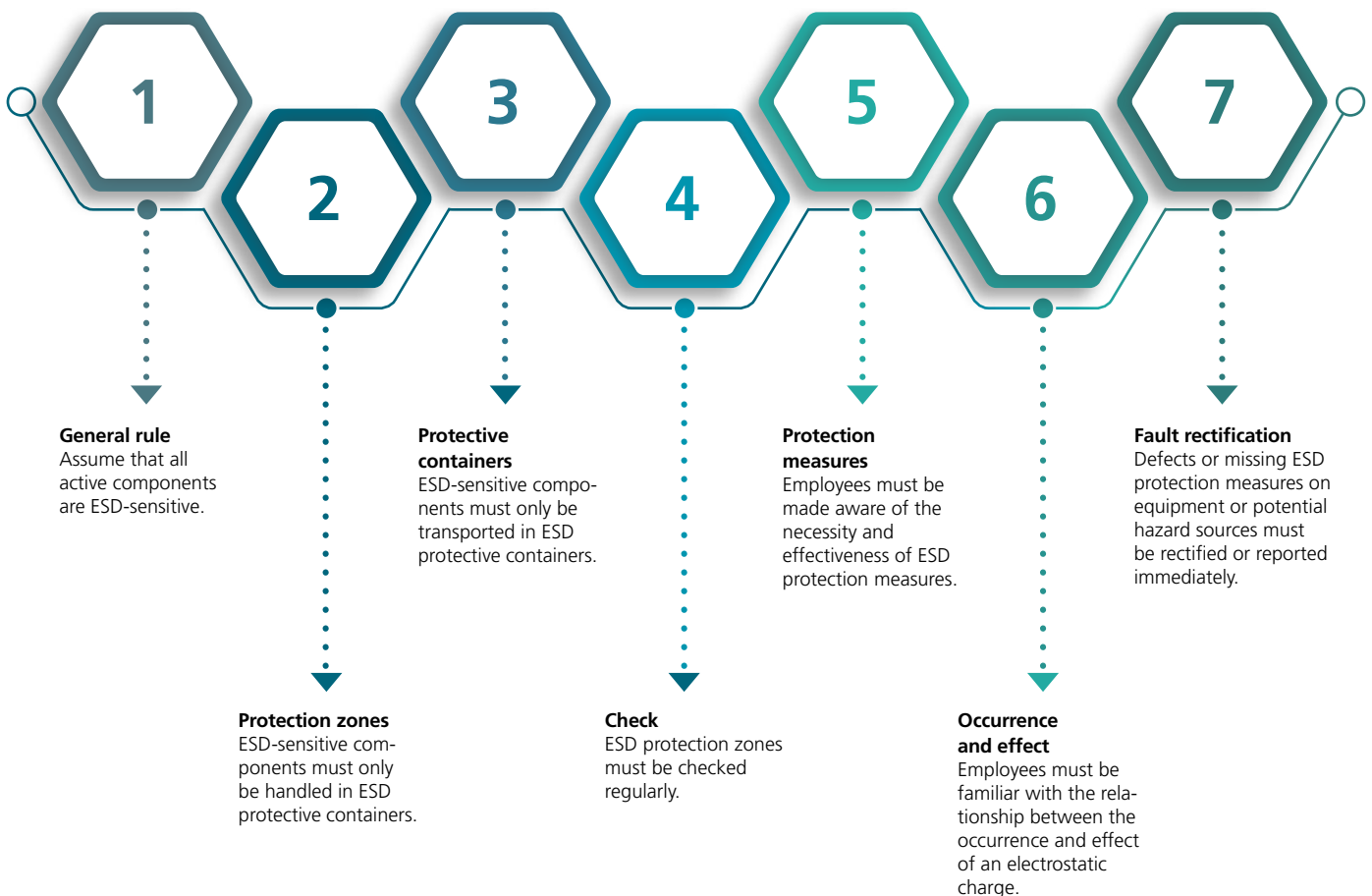



Locking systems

## STATE-OF-THE-ART SECURITY

The new generation of LISTA locking systems offers ease of use and cutting-edge security. Modern technologies make our electronic locking systems even more flexible and easier to use. The different systems can be freely combined to create a locking system that ideally suits you and your requirements. We are happy to advise you.

- + Modular locking system**  
perfectly adapted to your needs
- + Easy to use**  
directly on the lock  
(in all variants)
- + Optimal control and management**  
via software with standard USB cable connected to the USB front port on the lock (in variants .C, .F or .A)
- + Capacitive keypad**  
impervious to wear and easy to clean thanks to PCT technology
- + Mobile access**  
via RFID badge and RFID card
- + Easy energy supply**  
via mains adaptor or batteries for easy replacement on the front of the lock
- + Optional retrofitting**  
for existing cabinets

## OVERVIEW OF LISTA ACCESS SOLUTIONS



### KEY LOCK

Proven standard locking system

KEY Lock, our standard locking system with replaceable cylinders.

- manual opening/locking with key
- simultaneously lockable for multiple, as well as different, products with only one key or separately lockable with several keys
- key availability guaranteed for years



### CODE LOCK

The solution with number combination

When locking with CODE Lock, the key is replaced by a number combination. A simple four to six-digit code is all that is needed to open the product.

- manual opening/locking with number code
- lock readout and programming with LISTA Access software (option)



### RFID LOCK

Ready for the future: The solution with RFID badge

In addition to the CODE Lock, the LISTA RFID Lock enables opening and locking via standard radio-frequency identification (RFID). It consists of a transponder in the lock and standard mobile RFID badges/cards/tags.

- **manual opening/locking** via RFID badge or number code
- most standard RFID badges/cards/tags can be used
- lock readout and programming with LISTA Access software (option)



### AUTO LOCK





The ultimate solution: Automatic opening and locking

The LISTA AUTO Lock features the same functionality as our RFID Lock, however opening and locking take place automatically. With LISTA Access software (option), time profiles can also be programmed in the lock or on the user for time-limited access for increased security.

- **automatic opening/locking** via RFID badge or number code
- most standard RFID badges/cards/tags can be used
- locks automatically after a preset time or at the push of a button
- lock readout and programming with LISTA Access software (option)
- time-limited access programmable via LISTA Access software (option)



## LISTA LOCKING SYSTEMS IN A DIRECT COMPARISON

	 KEY Lock	 CODE Lock	 RFID Lock	 AUTO Lock
<b>MANUAL ACCESS</b>				
Key	+			
Do not exceed max. number of different cylinders	as many as you like			
Do not exceed max. number of locks:	as many as you like			
<b>ELECTRONIC ACCESS</b>				
Code		+	+	+
Do not exceed max. number of user codes		100	100	100
RFID			+	+
Do not exceed max. number of locks:		as many as you like	as many as you like	as many as you like
Automatic opening/locking				+
<b>MANAGEMENT</b>				
Lock ID Code		+	+	+
LISTA Access software		+	+	+
<b>INTERFACES</b>				
Free contact for external systems			+	+

## EXTENSIVE ACCESSORIES FOR OUR LOCKING SYSTEMS



**Basic set**  
 1 AC/DC adapter (12W/5V)  
 1 Combi-lock connection, complete  
 1 Assembly instructions  
 4 Cable ties  
 Art. no. **19.160.000**



**Expansion set**  
 1 Combi-lock connection, complete  
 1 Connection cable, 2m  
 4 Cable ties  
 Art. no. **19.161.000**



**Extension cord set**  
 1 Connection cable, 2m (one set is required per two metres)  
 Art. no. **19.162.000**



**Program badges**  
 Set of 5, colour: white  
 Art. no. **19.581.000**



**User badges**  
 Set of 5, colour: blue  
 Art. no. **19.580.000**



**RFID card reader**  
 for PC  
 Art. no. **19.591.000**



**Security eCard**  
 2 items  
 Art. no. **19.579.000**



When ordering a **LISTA product with electronic lock**, please add the suffix of the relevant **lock type/locking type (.C, .F or .A)** to the article number from the table (e.g. **71.088.XXX.C**).

**Order example for drawer cabinet with:**

**CODE Lock** = 71.088.XXX.C  
**RFID Lock** = 71.088.XXX.F  
**AUTO Lock** = 71.088.XXX.A

## FULL CONTROL WITH LISTA ACCESS



With the LISTA Access software, you have a particularly easy and user-friendly solution for managing and configuring your LISTA CODE, RFID or AUTO Lock. It enables faster learning and management of the lock, users and user groups via USB. Other additional functions are also available such as changing the lock ID code or creating summary assignment tables (permissions).

### System requirements

Operating system: Windows 7 or higher

CPU: Intel Atom or similar (recommended Intel i3 or higher)

RAM: 2 GB (recommended 4 GB)

Free hard disk space: 500 MB (recommended 1 GB)



### Functions

- Lock training and management
- User management
- Group classification
- Assignment table (permissions)
- Synchronisation of lock and database via USB



### LISTA Access software

Art. no. 19.590.000

Further information and downloads at:  
[www.lista.com/locks](http://www.lista.com/locks)

LISTA Electronic Control

# SECURITY AT ALL LEVELS

The electronically controlled access system LISTA Electronic Control gives you maximum flexibility to allocate and manage access rights. This means that you can not only control access to the entire cabinet, individual drawers or the drawer compartments developed specially for this system but can also combine different system versions in a single cabinet. Just as required.

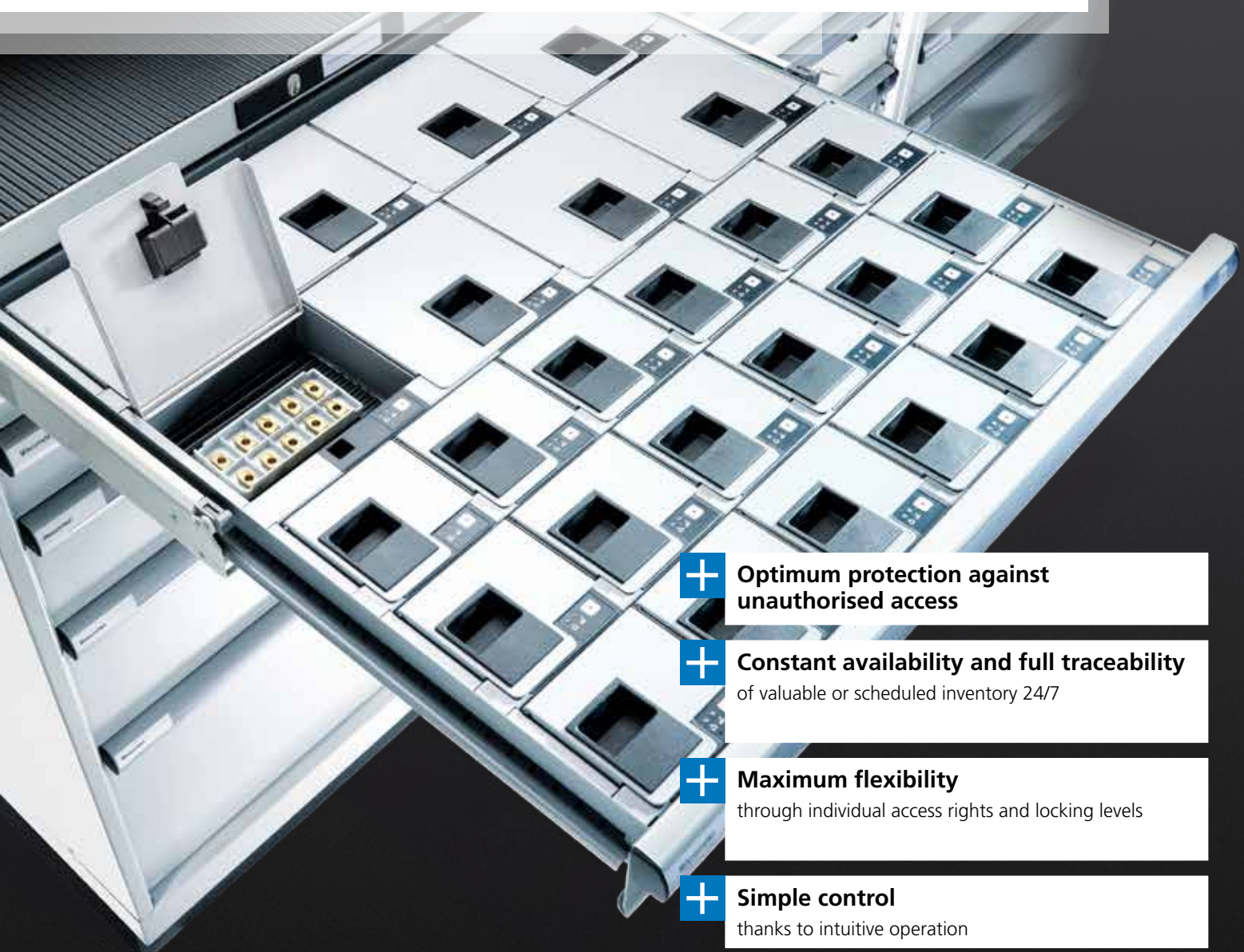

- + Optimum protection against unauthorised access**
- + Constant availability and full traceability** of valuable or scheduled inventory 24/7
- + Maximum flexibility** through individual access rights and locking levels
- + Simple control** thanks to intuitive operation
- + Additional security** through metal drawer compartments specially developed for this system
- + Reduced inventory loss and better planning** giving direct cost savings and increased productivity



## THE MODULAR SYSTEM FOR INTERNAL LOGISTICS SOLUTIONS

Level 1 Security

» Access control at cabinet level

### LCC – LISTA Cabinet Control

Electronically controlled access to the entire cabinet.  
Available for sizes  
36 × 36 E (717 × 725 mm)  
54 × 36 E (1023 × 725 mm)

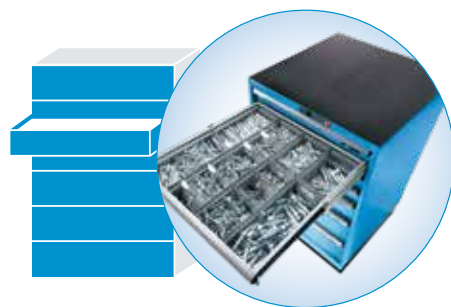

Level 2 Security

» Access control at drawer level

### LDC – LISTA Drawer Control

Electronically controlled access to specific individual drawers. Available for sizes  
36 × 36 E (717 × 725 mm)  
54 × 36 E (1023 × 725 mm)

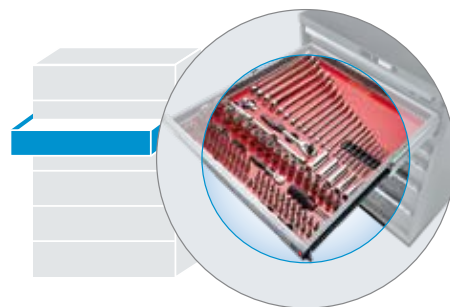

Level 3 Security

» Access control at compartment level

### LPC – LISTA Parts Control

Electronically controlled access to specific drawer compartments. Available for sizes  
36 × 36 E (717 × 725 mm)

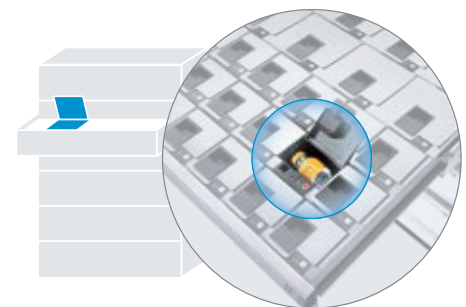

## eCONTROL



### Don't search, find

LISTA eControl provides you with a tailor-made software solution for the storage and access management of your LISTA products. The software ensures optimal management so that you can access the desired product with as few steps as possible. eControl is simple, self-explanatory and event-controlled, so withdrawals are also possible without prior entry. The solution can optionally be integrated into your existing ERP system via an interface and – in addition to full transparency and time-saving withdrawal – also enables comprehensive controlling based on data and evaluations.



**LISTA Electronic Control is available either as a complete system consisting of hardware and software or as hardware only to enable you to use your own software.**

LISTA EDGE

## GET THE LOOK

**More form for your workspace:** Discover EDGE, the new LISTA design cabinet with LED technology. The ultimate eye-catcher is available in two variants and different dimensions. Look forward to an individual statement light in the workshop, sales room, studio and office.



EDGE  
GET THE LOOK



### Form right down the line: EDGE LINE

- Vertical light strip along the cabinet front left and right
- Geometrical, uniform overall appearance
- Colour white
- Available in cabinet height 850 mm (other versions on request)



### Form to the point: EDGE DOTS

- Individually controlled LED elements on the handle corners
- Technologically dynamic radiance
- Available in four colours (with optional myDOTS software package, colour mixing and intensity can be individually adjusted)
- Available in cabinet heights of 700, 800, 850, 1000, 1150, 1450 mm (other versions on request)

## EDGE STATEMENT LIGHT: HIGHLIGHTS

Individual light signature

Expressive accentuation

High-quality radiance

Two versions:  
Strip (LINE) or point (DOTS)

Different lighting moods

Sustainable LED technology

Material flow

# OPTIMUM PROCESSES

Workspace equipment is important for efficient workflows in your business. LISTA therefore offers you a wide range of storage and workstation systems that can be optimally adapted to your workflow and combined into a process-optimised solution. LISTA systems include storage solutions from universal shelving to warehouse lifts, the individually configurable workstation system, linking options, workbenches and mobile solutions. LISTA also provides driverless transport systems for the automated transport of goods and materials within the company. All in all: the best conditions for optimising your material flow.

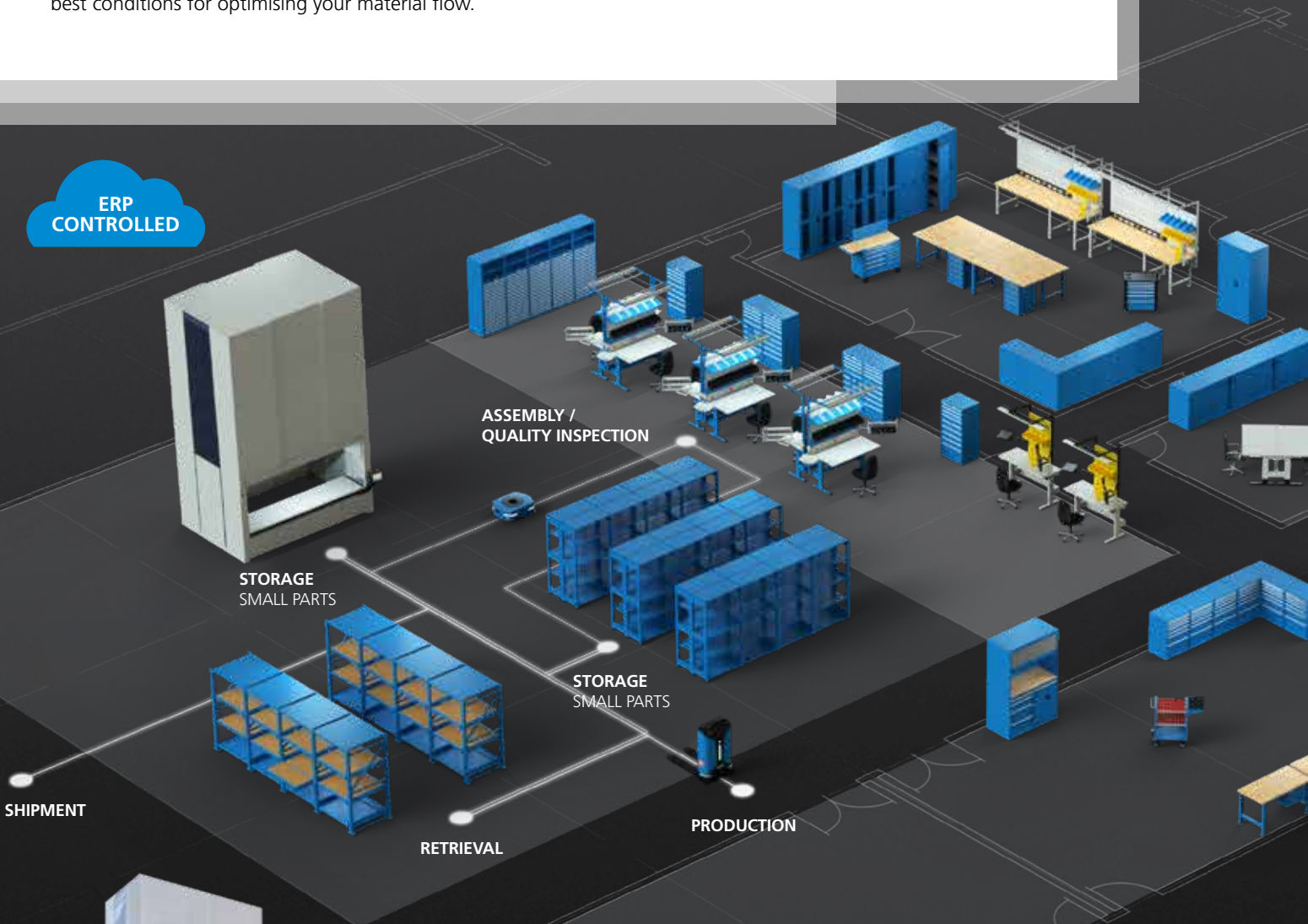

Storage lifts  
Further information on LISTA's space-saving, time-saving and cost-saving vertical storage system can be found in our LISTA LIFT brochure.

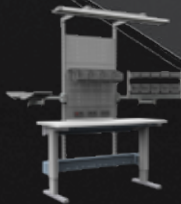

Workstation systems  
See p. 106.

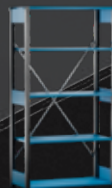

Shelving  
See p. 218.



## LISTA SLIM

LISTA SLIM provides you with a particularly efficient solution for your intralogistics. The system offers a high loading capacity with low unladen weight. The lifting height can be adjusted up to 3 m depending on the lifting capacity. At the same time, 360° collision protection, millimetre-accurate navigation and the automatic charging function ensure maximum safety and reliability.



## LISTA FLOW

Its technical features and high functionality make the FLOW series one of the leading AGVs for loading capacities up to 1000 kg. Thanks to its combined navigation with laser/QR, it achieves optimum accuracy with the highest possible safety and efficiency.



Belt



Heavy Carrier



Castors



Order



Picking Fork



Picking Plus

## OTHER AGV SOLUTIONS

In addition to vehicles for automated material flow in industrial environments, driverless transport systems for picking and sorting supplement the LISTA AGV range. This gives you the right solution for a wide range of applications, such as retail or shipping, from vertical pickers to manoeuvrable small sorters.

## YOUR ADVANTAGES WITH DRIVERLESS TRANSPORT SYSTEMS

- Automated product movement
- Fast storage and retrieval
- Decreasing error rate
- Reduced product damage
- Reduced labour requirements
- Greater flexibility in the warehouse
- Improved safety at the workstation
- Exceptional value for money

# ROBUST ALL-ROUNDERS

**LISTA drawer cabinets provide a robust and well protected storage option for equipment and many other items.** High-quality specifications and a variety of individual configuration options make these robust all-rounders ideal for a wide variety of requirements and environments. Their special design guarantees optimum space utilisation. In addition, housing and drawers can be variably partitioned, intelligently labelled, protected with access control and finished in almost any colour. Nowhere else will you find this degree of flexibility.





- + Utmost stability**  
load capacity of housing up to 4 t; load capacity of drawers 75 or 200 kg
- + Can be utilised to the full**  
since drawers can be fully extended and the drawer shell heights are optimised
- + Well protected**  
against dirt, liquids and mechanical load through closed housing with impact and abrasion-resistant surface
- + Outstanding safety features**  
safety catch to prevent unwanted drawer opening and anti-tilt mechanism to prevent opening of more than one drawer at a time
- + Corrosion protection**  
with electrophoretic dip painting and environmentally-friendly powder coating
- + Optimum order and organisation**  
thanks to special LISTA partition material for every purpose and perforated, slotted drawers
- + Professional labelling**  
with LISTA Script labelling software and clip-on label holders which fold upwards
- + Perfectly smooth running**  
through differential pull-out without a crossbar
- + Flexibly adaptable**  
through pre-perforated holes for table tops (punch-outs), rollers, drawers, locking systems for easy retro-fitting and refitting
- + Secure locking option**  
with interchangeable cylinder for adaptation to existing locking systems and electronic locking systems via CODE, RFID or AUTO Lock
- >> Fully compatible with LISTA partition material thanks to the standardised unit of measure** see p. 248

# Drawer cabinets



## + Maximum use of drawer space

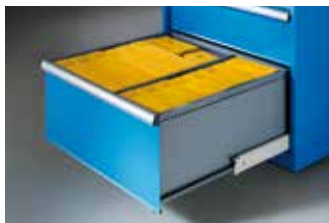

### Optimum shell height

- drawer sides and rear panels the same height as the fronts
- maximum use of vertical space
- optimum protection against items falling out and loss of stored items



### Full extension

- maximum use of horizontal space
- everything in view
- optimum access

## + Perfectly smooth running



### Pull-out without crossbar

- perfectly smooth running and ease of movement through differential pull-out without a crossbar
- enables the drawer to be fully extended



### Quiet locking tab

- special plastic cover in the locking tab
- smooth and quiet locking process

## + Professional labelling



### Label holder which folds upwards

- on drawers, troughs, metal dividers, separators and housing
- for easy, clean and protected labelling



### LISTA Script

The LISTA Script labelling software offers:

- numerous labelling options
- pictograms
- barcode generator

As a LISTA customer, you can download our LISTA Script labelling software free of charge from our website under Products › Accessories › LISTA Script.

## + Partition material for every purpose

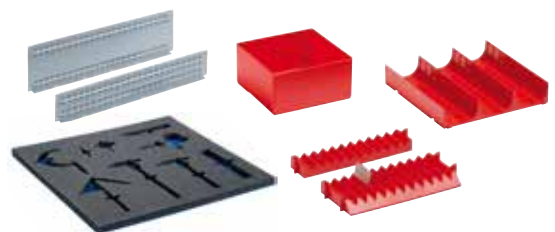

### The LISTA standard

Our drawer partition materials are standardised and therefore compatible with the entire LISTA range.

» Drawer partition material see p. 248

» LISTA Script slide-in labels see p. 268



# Benefits of LISTA storage systems

## Storage in drawers

Storing small parts in drawers rather than on shelves ensures that stored items are protected from dust and contamination while saving space and optimising organisation. The entire contents of the drawer are visible in no time, whereas with a shelf, items may have to be moved or reached over to gain access.

- The depth of a compartment can be adapted to suit the stored items at any time, and any number of parts can be placed one behind the other
- By simply pulling out the drawer, you can clearly see the contents and have everything within reach in a truly space-saving way

### + Example of space requirement

Usable depth  $4 \times 600 = 2400 \text{ mm}$   
 Depth of aisle  $2 \times 1000 = 2000 \text{ mm}$  } Total 4400 mm

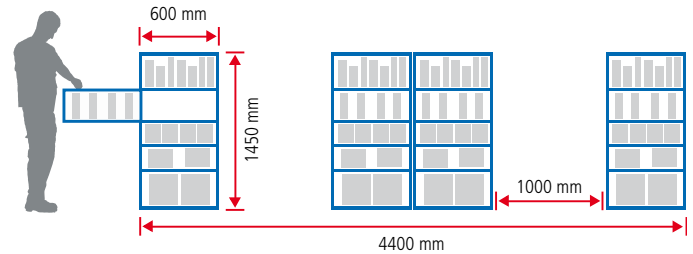

## Storage on shelves

- If the parts are smaller than the depth of the shelves, there is a lot of unused space behind the goods
- If the items are stored behind one another, then space is needed for both visibility and access

### - Example of space requirement

Usable depth  $8 \times 300 = 2400 \text{ mm}$   
 Depth of aisle  $4 \times 800 = 3200 \text{ mm}$  } Total 5600 mm

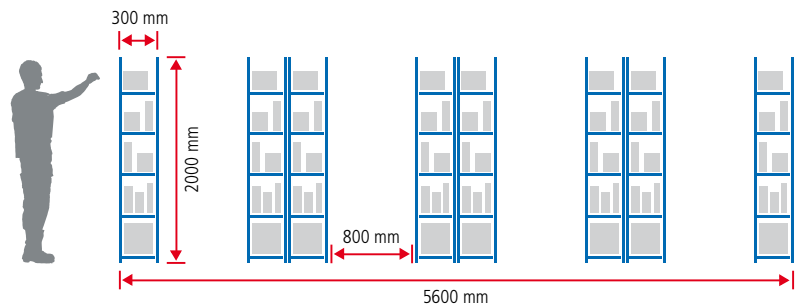

## + Optimum order and organisation

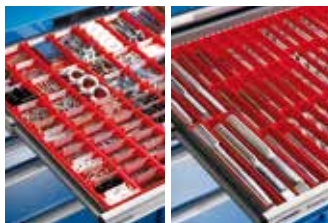

**Plastic boxes and troughs**  
for small and cylindrical items



**Tool holders**  
for NC storage



**Metal separators**  
for different sized parts



**PE foam inserts**  
for special and measuring tools



### Perforated, slotted drawers hold items firmly in place

- a series of slots around the drawer walls hold the partitioning material firmly in place
- perforated drawer bases enable slotted dividers, metal separators, dividers, holding pins or milling cutter holders to be optionally screwed in place

LISTA Units	Depth 27 E				Depth 36 E							
	18 × 27 E	27 × 27 E	36 × 27 E	54 × 27 E	18 × 36 E	27 × 36 E	36 × 36 E	45 × 36 E	54 × 36 E	64 × 36 E	78 × 36 E	
Cabinet floor area mm	411 × 572	564 × 572	717 × 572	1023 × 572	411 × 725	564 × 725	717 × 725	870 × 725	1023 × 725	1193 × 725	1431 × 725	
Drawer useful space mm	306 × 459	459 × 459	612 × 459	918 × 459	306 × 612	459 × 612	612 × 612	765 × 612	918 × 612	1088 × 612	1326 × 612	

# Drawer cabinets

## + Flexibly adaptable

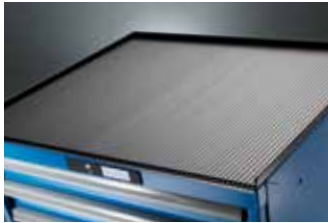

### Variable raised edges

- raised edges on three sides of stationary cabinets for simple and easy cleaning
- raised edges on four sides of mobile cabinets to protect the goods being transported



### Punch out

- housing covers with pre-perforated holes which can be punched out
- for retrofitting with a table top or second drawer cabinet on top



### Base/forklift base

- optional base and forklift base (for drawer cabinets with a width of 36 E and over)
- makes it easy to adjust the height of the drawer cabinet
- enables the loaded cabinet to be lifted and moved with a forklift truck



### Mobile cabinets

- Our mobile cabinets are supplied with:
- raised edges on all four sides and push-bar
  - black ribbed mat
  - two swivel castors with brakes
  - two fixed castors and single-drawer locking mechanism
- Stationary cabinets can be converted to mobile cabinets at any time.

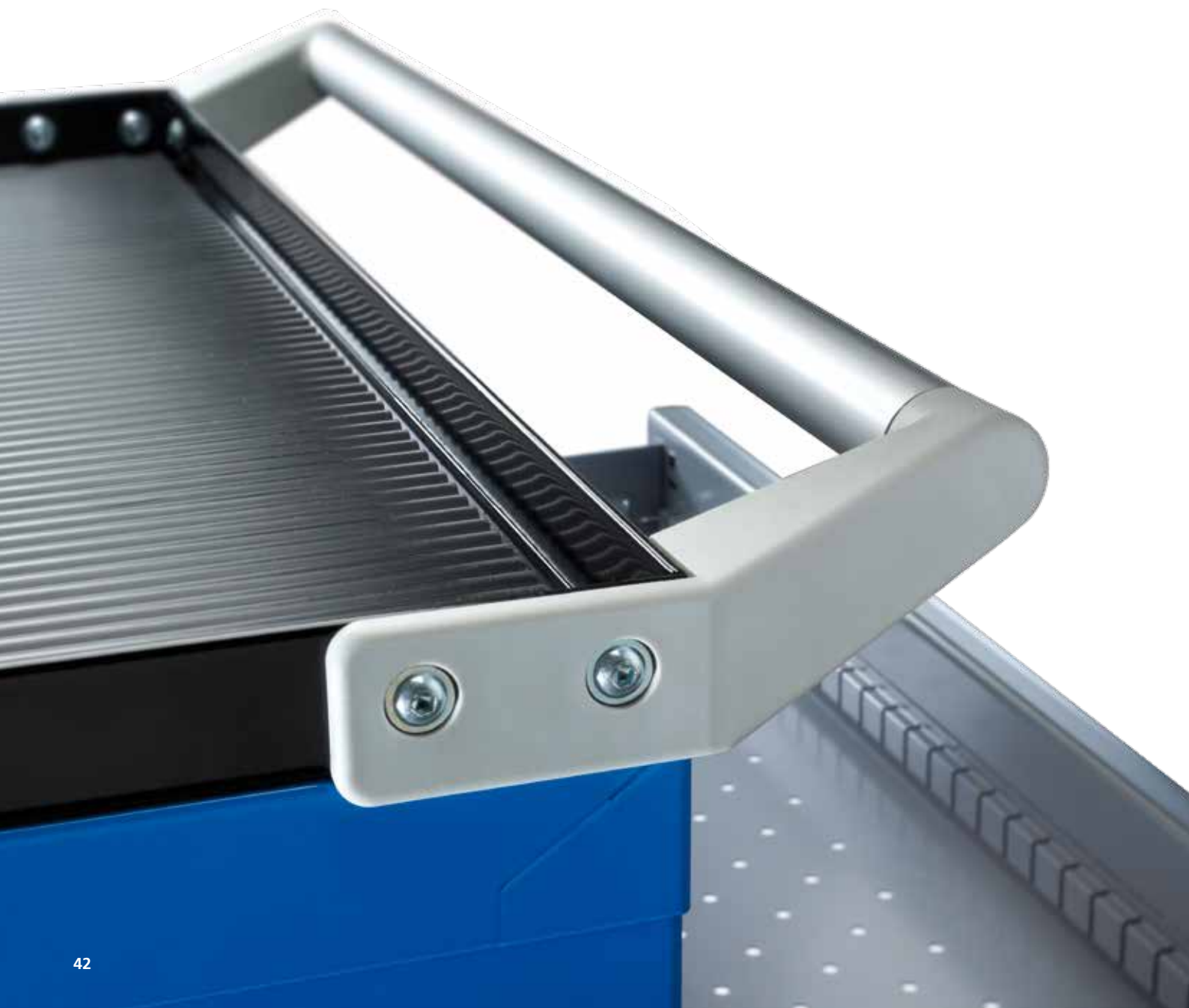

## + Individual configuration options

As standard, LISTA drawer cabinets are available in seven different widths, two depths and a variety of heights. The configuration options in terms of size, equipment, locking system, colour and drawer partitions are almost unlimited.

Our drawer cabinets can be combined individually to suit any working environment in order to make maximum use of available space. They can be extended at any time and therefore offer a scalable solution tailored to your needs.

### Typical configurations



Configuration as a drawer cabinet



Configuration as a drawer cabinet with recessed hinged door, pull-out shelves and adjustable shelves



Configuration as a drawer cabinet with drawers, recessed hinged door, pull-out shelves and adjustable shelves



Configuration as a mobile drawer cabinet with raised edges and a push-bar



Toolbox: Drawer cabinet with combined drawer widths (64/36/18 E).  
Version: stationary or mobile



ESD version available on request



## + Outstanding safety features



### Single drawer opening as standard

- prevents the cabinet from tipping over by blocking all other drawers when one drawer is pulled out
- allows for drawers to be moved around into a different arrangement at any time



### Flush drawer front

- drawer handles with side covers which sit snugly within the front profile
- look good and are safe



### Safety catches

- comply with all regulations against drawers accidentally falling out of cabinets
- reduce the risk of injuries at the workplace
- can easily be deactivated in order to move individual drawers



### Information on load capacity

- the load capacity (75 or 200 kg) is inscribed on the drawer runners
- increased safety

## + Extra safety for stationary and mobile cabinets



### Safety catch on right

- our standard safety catch for all mobile cabinets
- can be operated with one hand



### Single safety catch on the right and left

- especially suitable for mobile equipment
- both hands are needed to operate them



### Double safety catch

- has all the same features as the single safety catch on the left and the right
- easier to use since it can be operated with one hand



### Lilo locking device

- with external lever for fixing the fully laden drawer in either open or closed position
- for a drawer load capacity of 200 kg

# Drawer cabinets

## Countless configuration options



### Covers

Raised edges on three sides and ribbed mat, Resin-coated cover panel, Multiplex cover panel, Raised edges on 4 sides, with push-bar (for mobile cabinets)



### Partition material

Slotted dividers, separators, trough walls, metal separators, label holders, plastic boxes and trough separators, milling cutter holders and holding pins, non-slip mats, foam inserts and much more.



### Inserts and add-ons

Drawers, pull-out and adjustable shelves, hinged doors



### Locking systems

KEY Lock, CODE Lock, RFID Lock or AUTO Lock

### Substructures

Housing base, 2-way pallet/forklift truck base, Pairs of castor holders, individual castors and levelling feet

## Order preconfigured models

» Page 46–59



LISTA Units



1. Pre-configured ordering examples

» Page 248



2. Partition material

▪ or options

## ... or configure and order cabinets individually

» Page 60–65



LISTA Units

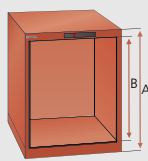

1. Housing

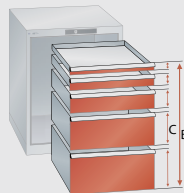

2. Drawers



3. Accessories

» Page 248



4. Partition material

- select the cabinet floor area (e. g. 717 × 572 mm = 36 × 27 E or 717 × 725 mm = 36 × 36 E)
- LISTA Unit E × E = a unit of measure which helps to choose drawers and partition materials

- choice of various housing heights (A)
- the choice of housing always includes the choice of the preferred locking system and the colour

- define the height of the front, the load capacity, the colour and the type of safety catch
- sum of the drawer front heights (C) = clear height (B) (see diagram)

- can be equipped with drawers and doors
- select the cabinet accessories
- mobile cabinets must have a drawer safety catch and a push-bar

- select the partition material for the drawers
- N.B.: take the drawer height and usable surface into account!

## 12 standard colours

### Maximum flexibility thanks to free choice of colours

All products with a choice of colours are available in 12 standard colours and 6 colour combinations without surcharge. The three-digit colour code (e.g. **.010**) forms part of the article number. When ordering, please complete the article number by adding the desired three-digit colour code (e.g. **70.701.010**). Housings and drawers can also be ordered in different colours.



**.010** Light blue  
RAL 5012



**.020** Light grey  
RAL 7035



**.030** Reseda green  
RAL 6011



**.040** Capri blue  
RAL 5019



**.050** Metallic grey  
NCS S 6502-B



**.060** Black  
NCS S 9000-N



**.070** Ruby red  
RAL 3003



**.080** Pigeon grey  
NCS S 4502-B



**.090** Gentian violet  
RAL 5010



**.100** Signal blue  
RAL 5005



**.110** Pure white  
RAL 9010



**.200** Anthracite grey  
RAL 7016

## 6 colour combinations



**.514** Light grey  
RAL 7035  
Light blue  
RAL 5012



**.518** Light grey  
RAL 7035  
Signal blue  
RAL 5005



**.519** Light grey  
RAL 7035  
Metallic grey  
NCS S 6502-B



**.521** Metallic grey  
NCS S 6502-B  
Light grey  
RAL 7035



**.512** Light grey  
RAL 7035  
Ruby red  
RAL 3003



**.522** Ruby red  
RAL 3003  
Metallic grey  
NCS S 6502-B

## An additional 12 predefined colours

(at extra cost)



**.120** Grey aluminium  
RAL 9007



**.130** White aluminium  
RAL 9006



**.140** Light grey  
NCS S 2000-N



**.170** Ultramarine blue  
RAL 5002



**.180** Grey white  
RAL 9002



**.190** Sky blue  
RAL 5015



**.210** Brilliant blue  
RAL 5007



**.220** Turquoise blue  
RAL 5018



**.230** Pebble grey  
RAL 7032



**.240** Flame red  
RAL 3000



**.260** Slate grey  
RAL 7015



**.280** Orange  
RAL 2004

### Your individual choice of colour on request

LISTA is able to deliver any individual colour on request. In addition to the existing standard and predefined colours, it is also possible to produce your desired product in any colour you choose on request.



Due to the printing process, these colour samples may deviate from the original colours.

# Drawer cabinets | stationary and mobile



Art. no. **78.414.521**  
Housing: Metallic grey, NCS 6502-B  
Fronts: Light grey, RAL 7035  
(excluding partition material)



Art. no. **78.423.070.C**  
Ruby red, RAL 3003  
(excluding partition material)

## Mobile cabinets

All mobile drawer cabinets on these two pages are equipped with:  
1 raised edge on 4 sides and ribbed mat,  
1 push-bar,  
1 pair castor holders with nylon castors Ø 100 mm,  
Drawer safety catch on right, Load capacity 400 kg

**18 × 27 E**    **W** → 411 mm    **D** ↗ 572 mm

306 × 459 mm



	<b>H</b> ↑	Number of drawers mm	kg	Locking system	Art. no.
<b>283</b>		2: 1 × 50 / 1 × 150	75	KEY Lock	<b>78.400.XXX</b>
<b>283</b>		2: 2 × 100	75	KEY Lock	<b>78.402.XXX</b>
<b>283</b>		3: 1 × 50 / 2 × 75	75	KEY Lock	<b>78.404.XXX</b>
<b>383</b>		3: 1 × 50 / 1 × 100 / 1 × 150	75	KEY Lock	<b>78.406.XXX</b>
<b>383</b>		3: 2 × 75 / 1 × 150	75	KEY Lock	<b>78.408.XXX</b>
<b>383</b>		4: 1 × 50 / 2 × 75 / 1 × 100	75	KEY Lock	<b>78.410.XXX</b>
<b>533</b>		4: 1 × 50 / 1 × 100 / 2 × 150	75	KEY Lock	<b>78.414.XXX</b>
<b>700</b>		3: 1 × 100 / 1 × 200 / 1 × 300	75	KEY Lock	<b>78.418.XXX</b>
<b>700</b>		5: 2 × 75 / 3 × 150	75	KEY Lock	<b>78.420.XXX</b>
<b>723</b>		4: 1 × 50 / 1 × 100 / 2 × 150	75	KEY Lock	<b>78.423.XXX</b>
<b>723</b>		5: 2 × 50 / 2 × 100 / 1 × 150	75	KEY Lock	<b>78.425.XXX</b>
<b>840</b>		6: 2 × 50 / 2 × 75 / 2 × 150	75	KEY Lock	<b>78.427.XXX</b>



When ordering a drawer cabinet from these two pages with **CODE Lock**, please add the suffix "**C**" or for **RFID** or **AUTO Lock** the suffix "**F**" or "**A**" to the article number from the table (e.g. **78.467.XXX.C**).

Other locking systems see p. 28–31

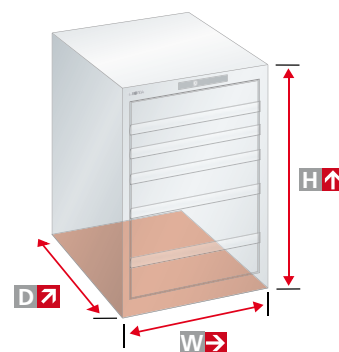

kg = load capacity  
🔒 = locking system



**27 × 27 E**    **W** → 564 mm    **D** ↗ 572 mm

459 × 459 mm



<b>H</b> ↑	Number of drawers mm	<b>kg</b>	<b>Lock</b>	Art. no.
283	2: 1 × 50 / 1 × 150	75	KEY Lock	78.461.XXX
283	2: 2 × 100	75	KEY Lock	78.463.XXX
283	3: 2 × 50 / 1 × 100	75	KEY Lock	78.465.XXX
383	2: 1 × 100 / 1 × 200	75	KEY Lock	78.467.XXX
383	3: 1 × 50 / 1 × 100 / 1 × 150	75	KEY Lock	78.469.XXX
383	4: 1 × 50 / 2 × 75 / 1 × 100	75	KEY Lock	78.471.XXX
700	6: 1 × 50 / 2 × 75 / 2 × 100 / 1 × 200	75	KEY Lock	78.486.XXX
800	4: 2 × 100 / 1 × 200 / 1 × 300	75	KEY Lock	78.289.XXX
800	5: 1 × 50 / 2 × 100 / 1 × 150 / 1 × 300	75	KEY Lock	78.882.XXX
850	4: 1 × 100 / 1 × 150 / 1 × 200 / 1 × 300	75	KEY Lock	79.380.XXX
850	5: 1 × 100 / 3 × 150 / 1 × 200	75	KEY Lock	14.256.XXX
850	6: 2 × 75 / 2 × 100 / 2 × 200	75	KEY Lock	14.258.XXX
850	6: 1 × 50 / 2 × 100 / 2 × 150 / 1 × 200	75	KEY Lock	78.953.XXX
850	7: 2 × 75 / 3 × 100 / 2 × 150	75	KEY Lock	14.252.XXX
850	8: 1 × 50 / 2 × 75 / 4 × 100 / 1 × 150	75	KEY Lock	14.250.XXX
723	4: 1 × 50 / 1 × 75 / 1 × 125 / 1 × 200	75	KEY Lock	78.489.XXX
723	5: 1 × 50 / 2 × 75 / 1 × 100 / 1 × 150	75	KEY Lock	78.491.XXX
840	6: 2 × 50 / 2 × 75 / 2 × 150	75	KEY Lock	78.493.XXX
890	5: 4 × 100 / 1 × 200	75	KEY Lock	14.249.XXX
890	6: 1 × 50 / 2 × 75 / 2 × 100 / 1 × 200	75	KEY Lock	14.247.XXX
890	6: 2 × 75 / 3 × 100 / 1 × 150	75	KEY Lock	14.245.XXX

**S** Art. no. **14.252.010**  
Light blue, RAL 5012  
(excluding partition material)



**S**  
**S**

**S**  
**S**

Art. no. **14.245.020**  
Light grey, RAL 7035  
(excluding partition material)

**S** **LISTA quick delivery range**  
These LISTA products in the colours light blue (.010) and light grey (.020) are available ex-works at short notice.

**.010**

Light blue  
RAL 5012

**.020**

Light grey  
RAL 7035



# Drawer cabinets | stationary and mobile



Art. no. **78.556.521**  
 Housing: Metallic grey, NCS S 6502-B  
 Fronts: Light grey, RAL 7035  
 (excluding partition material)



**36 × 27 E**    **W** → 717 mm    **D** ↗ 572 mm

612 × 459 mm

<b>H</b> ↑	Number of drawers	mm	kg	Locking system	Art. no.
700	5: 1 × 50 / 2 × 100 / 1 × 150 / 1 × 200		75	KEY Lock	<b>78.556.XXX</b>
700	5: 2 × 75 / 2 × 100 / 1 × 250		75	KEY Lock	<b>78.560.XXX</b>
700	6: 2 × 75 / 3 × 100 / 1 × 150		75	KEY Lock	<b>78.564.XXX</b>
850	7: 1 × 50 / 2 × 75 / 2 × 100 / 1 × 150 / 1 × 200		75	KEY Lock	<b>78.568.XXX</b>
850	7: 2 × 75 / 2 × 100 / 2 × 125 / 1 × 150		75	KEY Lock	<b>78.572.XXX</b>
850	8: 4 × 75 / 3 × 100 / 1 × 150		75	KEY Lock	<b>78.576.XXX</b>
1000	7: 1 × 50 / 2 × 75 / 2 × 100 / 1 × 200 / 1 × 300		75	KEY Lock	<b>78.580.XXX</b>
1000	7: 2 × 75 / 1 × 100 / 3 × 150 / 1 × 200		75	KEY Lock	<b>78.584.XXX</b>
1000	8: 1 × 50 / 2 × 75 / 3 × 100 / 1 × 150 / 1 × 250		75	KEY Lock	<b>78.588.XXX</b>
957	5: 1 × 50 / 2 × 100 / 1 × 150 / 1 × 200		75	KEY Lock	<b>78.604.XXX</b>
957	5: 2 × 75 / 2 × 100 / 1 × 250		75	KEY Lock	<b>78.608.XXX</b>
957	6: 2 × 75 / 3 × 100 / 1 × 150		75	KEY Lock	<b>78.606.XXX</b>

**i**

When ordering a drawer cabinet from these two pages with **CODE Lock**, please add the suffix **"C"** or for **RFID** or **AUTO Lock** the suffix **"F"** or **"A"** to the article number from the table (e.g. **78.467.XXX.C**).

➤ Other locking systems see p. 28–31



Art. no. **78.608.030**  
 Reseda green, RAL 6011  
 (excluding partition material)

## Mobile cabinets

All mobile drawer cabinets on these two pages are equipped with:  
 1 raised edge on four sides including ribbed mat, 1 push-bar, 1 pair of castor holders with rubber castors Ø 160 mm, single drawer safety catch on the right, load capacity 600 kg

= load capacity  
 = locking system





Art. no. **78.782.010**  
Light blue, RAL 5012  
(excluding partition material)



Art. no. **69.561.200**  
Anthracite grey, RAL 7016  
(incl. folding countertop, perforated side panel and perforated rear panel)

» Toolbox  
see p. 72–73

**54×27 E** W → 1023 mm D ↗ 572 mm

918×459 mm



H ↑	Number of drawers mm	kg	Lock	Art. no.
850	5: 3×100 / 1×150 / 1×300**	75	KEY Lock	<b>78.742.XXX</b>
850	5: 3×100 / 1×150 / 1×300	200	KEY Lock	<b>78.744.XXX</b>
850	6: 2×75 / 2×100 / 1×150 / 1×250**	75	KEY Lock	<b>78.746.XXX</b>
850	6: 2×75 / 2×100 / 1×150 / 1×250	200	KEY Lock	<b>78.748.XXX</b>
850	7: 1×50 / 2×75 / 2×100 / 1×150 / 1×200	75	KEY Lock	<b>78.750.XXX</b>
850	7: 1×50* / 2×75 / 2×100 / 1×150 / 1×200	200	KEY Lock	<b>78.752.XXX</b>
1000	6: 3×100 / 2×150 / 1×300**	75	KEY Lock	<b>78.754.XXX</b>
1000	6: 3×100 / 2×150 / 1×300	200	KEY Lock	<b>78.756.XXX</b>
1000	7: 2×75 / 1×100 / 3×150 / 1×200	75	KEY Lock	<b>78.758.XXX</b>
1000	7: 2×75 / 1×100 / 3×150 / 1×200	200	KEY Lock	<b>78.760.XXX</b>
1000	8: 2×75 / 4×100 / 1×150 / 1×200	75	KEY Lock	<b>78.762.XXX</b>
1000	8: 2×75 / 4×100 / 1×150 / 1×200	200	KEY Lock	<b>78.764.XXX</b>
1450	9: 2×75 / 2×100 / 2×150 / 2×200 / 1×300**	75	KEY Lock	<b>78.766.XXX</b>
1450	9: 2×75 / 2×100 / 2×150 / 2×200 / 1×300	200	KEY Lock	<b>78.768.XXX</b>
1450	10: 2×75 / 3×100 / 2×150 / 3×200	75	KEY Lock	<b>78.770.XXX</b>
1450	10: 2×75 / 3×100 / 2×150 / 3×200	200	KEY Lock	<b>78.772.XXX</b>
1450	11: 2×75 / 5×100 / 2×150 / 2×200	75	KEY Lock	<b>78.774.XXX</b>
1450	11: 2×75 / 5×100 / 2×150 / 2×200	200	KEY Lock	<b>78.776.XXX</b>
957	4: 1×100 / 2×150 / 1×200	75	KEY Lock	<b>78.778.XXX</b>
957	5: 2×75 / 1×100 / 1×150 / 1×200	75	KEY Lock	<b>78.780.XXX</b>
957	6: 2×75 / 3×100 / 1×150	75	KEY Lock	<b>78.782.XXX</b>



Art. no. **78.770.020**  
Light grey, RAL 7035  
(excluding partition material)

**64×27 E** W → 1193 mm D ↗ 572 mm



H ↑	Number of drawers mm	kg	Lock	Art. no.
1090 <sup>1</sup>	9: 2×100 (64 E) / 2×150, 1×200 (36 E) / 2×150, 2×100 (18 E) / with folding countertop, perforated side panel and perforated rear panel	75	KEY Lock	<b>69.561.XXX</b>



## Drawer cabinets | stationary and mobile

**In addition to the stationary versions, all LISTA drawer cabinets are also available as mobile cabinets.** This increased mobility provides greater convenience and gains extra space. Mobile cabinets enable you to transport stored items easily and quickly and can conveniently be stored under a work surface if space is at a premium.

**+ Greater mobility**  
through smooth-running nylon and rubber castors, depending on the properties of the floor

**+ Optimum use of space**  
when positioned under work surfaces

**+ Safe and convenient**  
thanks to raised edges all round, ergonomic push-bar and additional drawer safety mechanisms

**>> Benefits of LISTA  
drawer cabinets**  
see p. 38/39



Art. no. **78.459.512**  
Housing: Light grey, RAL 7035  
Fronts: Ruby red, RAL 3003  
(excluding partition material)



Art. no. **78.449.010**  
Light blue, RAL 5012  
(excluding partition material)



Art. no. **78.439.512.C**  
Housing: Light grey, RAL 7035  
Fronts: Ruby red, RAL 3003  
(excluding partition material)

**18×36 E** W → **411 mm** D ↗ **725 mm**

 306×612 mm



H ↑	Number of drawers mm	kg	Locking system	Art. no.
283	2: 1×50 / 1×150	75	KEY Lock	<b>78.431.XXX</b>
283	2: 2×100	75	KEY Lock	<b>78.433.XXX</b>
283	3: 1×50 / 2×75	75	KEY Lock	<b>78.435.XXX</b>
383	3: 2×75 / 1×150	75	KEY Lock	<b>78.437.XXX</b>
383	3: 1×50 / 1×100 / 1×150	75	KEY Lock	<b>78.439.XXX</b>
383	4: 1×50 / 2×75 / 1×100	75	KEY Lock	<b>78.441.XXX</b>
700	3: 2×150 / 1×300	75	KEY Lock	<b>78.447.XXX</b>
700	5: 2×75 / 3×150	75	KEY Lock	<b>78.449.XXX</b>
723	4: 1×50 / 1×100 / 2×150	75	KEY Lock	<b>78.453.XXX</b>
723	5: 2×50 / 2×100 / 1×150	75	KEY Lock	<b>78.455.XXX</b>
840	6: 2×50 / 2×75 / 2×150	75	KEY Lock	<b>78.457.XXX</b>
890	5: 2×75 / 3×150	75	KEY Lock	<b>78.459.XXX</b>

**i** 

When ordering a drawer cabinet from these two pages with **CODE Lock**, please add the suffix **"C"** or for **RFID** or **AUTO Lock** the suffix **"F"** or **"A"** to the article number from the table (e.g. **78.467.XXX.C**).

➤ Other locking systems see p. 28–31

**Mobile cabinets**

All mobile drawer cabinets on this page are equipped with:  
1 raised edge on 4 sides and ribbed mat,  
1 push-bar,  
1 pair castor holders with nylon castors Ø 100 mm,  
Drawer safety catch on right, Load capacity 400 kg







# Drawer cabinets | stationary and mobile



**27 × 36 E**    **W** → 564 mm    **D** ↗ 725 mm

 459 × 612 mm

<b>H</b> ↑	Number of drawers mm	 kg	 Locking system	Art. no. 
<b>283</b>	2: 1 × 50 / 1 × 150	75	KEY Lock	<b>78.497.XXX</b>
<b>283</b>	2: 2 × 100	75	KEY Lock	<b>78.499.XXX</b>
<b>383</b>	3: 1 × 50 / 1 × 100 / 1 × 150	75	KEY Lock	<b>14.437.XXX</b>
<b>383</b>	3: 2 × 75 / 1 × 150	75	KEY Lock	<b>78.505.XXX</b>
<b>533</b>	4: 1 × 50 / 2 × 100 / 1 × 200	75	KEY Lock	<b>15.009.XXX</b>
<b>533</b>	5: 1 × 50 / 2 × 75 / 1 × 100 / 1 × 150	75	KEY Lock	<b>78.511.XXX</b>
<b>700</b>	5: 2 × 75 / 1 × 100 / 1 × 150 / 1 × 200	75	KEY Lock	<b>78.518.XXX</b>
<b>700</b>	4: 1 × 100 / 2 × 150 / 1 × 200	75	KEY Lock	<b>14.350.XXX</b>
<b>700</b>	6: 1 × 50 / 2 × 75 / 2 × 100 / 1 × 200	75	KEY Lock	<b>14.352.XXX</b>
<b>800</b>	4: 2 × 100 / 1 × 200 / 1 × 300	75	KEY Lock	<b>14.371.XXX</b>
<b>800</b>	5: 1 × 50 / 2 × 100 / 1 × 150 / 1 × 300	75	KEY Lock	<b>14.368.XXX</b>
<b>800</b>	6: 2 × 75 / 2 × 100 / 1 × 150 / 1 × 200	75	KEY Lock	<b>78.522.XXX</b>
<b>800</b>	7: 1 × 50 / 2 × 75 / 2 × 100 / 2 × 150	75	KEY Lock	<b>14.354.XXX</b>
<b>800</b>	7: 2 × 75 / 4 × 100 / 1 × 150	75	KEY Lock	<b>14.367.XXX</b>
<b>800</b>	1: 1 × 100 + 1 door 600, right / 1 adjustable shelf / 1 pull-out shelf	75	KEY Lock	<b>78.524.XXX</b>
<b>850</b>	4: 3 × 150 / 1 × 300	75	KEY Lock	<b>78.525.XXX</b>
<b>850</b>	5: 1 × 50 / 2 × 100 / 1 × 200 / 1 × 300	75	KEY Lock	<b>78.527.XXX</b>
<b>850</b>	6: 1 × 75 / 3 × 100 / 1 × 125 / 1 × 250	75	KEY Lock	<b>78.529.XXX</b>
<b>850</b>	5: 2 × 100 / 1 × 150 / 2 × 200	75	KEY Lock	<b>14.399.XXX</b>
<b>850</b>	6: 1 × 50 / 2 × 100 / 2 × 150 / 1 × 200	75	KEY Lock	<b>14.407.XXX</b>
<b>850</b>	7: 1 × 50 / 2 × 75 / 2 × 100 / 1 × 150 / 1 × 200	75	KEY Lock	<b>14.404.XXX</b>
<b>850</b>	7: 2 × 75 / 3 × 100 / 2 × 150	75	KEY Lock	<b>14.405.XXX</b>
<b>850</b>	8: 1 × 50 / 2 × 75 / 4 × 100 / 1 × 150	75	KEY Lock	<b>14.403.XXX</b>

 = load capacity  
 = locking system

Art. no. **14.367.519.C**  
 Housing: Light grey, RAL 7035  
 Fronts: Metallic grey, NCS S 6502-B  
 (excluding partition material)

**S**  
**S**

» Accessories  
 see p. 62

**S**  
**S**

**S**  
**S**

**S**  
**S**  
**S**  
**S**



## Equipped with drawers and doors

Drawer cabinets can optionally be fitted with drawers and a door. Because the door is recessed, special pull-out shelves are used. As standard, the two locks have different keys. Identical locks or a CODE/RFID Lock locking system are available on request (CODE/RFID Lock is not available for doors).

Art. no. **78.524.522**  
 Housing: Ruby red, RAL 3003  
 Fronts: Metallic grey, NCS S 6502-B  
 (excluding partition material)



**27 × 36 E** W → 564 mm D ↗ 725 mm

459 × 612 mm



H ↑	Number of drawers mm	kg	Lock	Art. no.
723	4: 1 × 50 / 2 × 100 / 1 × 200	75	KEY Lock	14.281.XXX
723	5: 2 × 50 / 2 × 100 / 1 × 150	75	KEY Lock	14.331.XXX
723	6: 2 × 50 / 2 × 75 / 2 × 100	75	KEY Lock	14.347.XXX

S  
S

890	5: 2 × 75 / 1 × 100 / 1 × 150 / 1 × 200	75	KEY Lock	78.546.XXX
890	6: 1 × 50 / 2 × 75 / 2 × 100 / 1 × 200	75	KEY Lock	78.548.XXX



990	5: 1 × 50 / 2 × 100 / 1 × 150 / 1 × 300	75	KEY Lock	14.374.XXX
990	5: 3 × 100 / 2 × 200	75	KEY Lock	14.397.XXX
990	7: 1 × 50 / 2 × 75 / 2 × 100 / 2 × 150	75	KEY Lock	14.372.XXX
990	7: 2 × 75 / 4 × 100 / 1 × 150	75	KEY Lock	14.373.XXX

S

S  
S



760	3: 1 × 50 / 1 × 100 / 1 × 150 / 1 set of support brackets (upper)	75	KEY Lock	70.632.XXX
760	1 adjustable shelf	75	-	78.216.XXX



810	1 adjustable shelf	75	-	70.633.XXX
-----	--------------------	----	---	------------

Art. no. **14.373.512**  
 Housing: Light grey, RAL 7035  
 Fronts: Ruby red, RAL 3003  
 (excluding partition material)

### Mobile cabinets

All mobile drawer cabinets on this page are equipped with:  
 1 raised edge on 4 sides and ribbed mat,  
 1 push-bar,  
 1 pair castor holders with nylon castors Ø 100 mm,  
 Drawer safety catch on right, Load capacity 400 kg



When ordering a drawer cabinet from these two pages with **CODE Lock**, please add the suffix "C" or for **RFID** or **AUTO Lock** the suffix "F" or "A" to the article number from the table (e.g. **78.467.XXX.C**).

Other locking systems see p. 28–31

### LISTA quick delivery range

These LISTA products in the colours light blue (.010) and light grey (.020) are available ex-works at short notice.

**.010** Light blue RAL 5012

**.020** Light grey RAL 7035



# Drawer cabinets | stationary and mobile



Art. no. **14.505.514.C**  
 Housing: Light grey, RAL 7035  
 Fronts: Light blue, RAL 5012  
 (excluding partition material)

**36 x 36 E**    **W** → 717 mm    **D** ↗ 725 mm

 612 x 612 mm

**H** ↑ **Number of drawers mm**

 kg



Art. no. 

**800**    **4:** 1 x 100 / 2 x 150 / 1 x 300    75    KEY Lock    **78.632.XXX**

**800**    **6:** 2 x 75 / 2 x 100 / 1 x 150 / 1 x 200    75    KEY Lock    **78.636.XXX**

**850**    **4:** 1 x 100 / 1 x 150 / 1 x 200 / 1 x 300    75    KEY Lock    **79.382.XXX**

**850**    **4:** 1 x 100 / 1 x 150 / 1 x 200 / 1 x 300    200    KEY Lock    **79.498.XXX**

**850**    **5:** 1 x 50 / 2 x 100 / 1 x 200 / 1 x 300    75    KEY Lock    **14.411.XXX**

**850**    **5:** 1 x 50\* / 2 x 100 / 1 x 200 / 1 x 300    200    KEY Lock    **14.505.XXX**

**850**    **5:** 1 x 100 / 3 x 150 / 1 x 200    75    KEY Lock    **14.410.XXX**

**850**    **5:** 1 x 100 / 3 x 150 / 1 x 200    200    KEY Lock    **14.504.XXX**

**850**    **7:** 1 x 50 / 2 x 75 / 2 x 100 / 1 x 150 / 1 x 200    75    KEY Lock    **78.640.XXX**

**850**    **7:** 1 x 50\* / 2 x 75 / 2 x 100 / 1 x 150 / 1 x 200    200    KEY Lock    **78.642.XXX**

**850**    **7:** 2 x 75 / 3 x 100 / 2 x 150    75    KEY Lock    **14.409.XXX**

**850**    **7:** 2 x 75 / 3 x 100 / 2 x 150    200    KEY Lock    **14.503.XXX**

**850**    **8:** 1 x 50 / 2 x 75 / 4 x 100 / 1 x 150    75    KEY Lock    **14.408.XXX**

**850**    **8:** 1 x 50\* / 2 x 75 / 4 x 100 / 1 x 150    200    KEY Lock    **14.502.XXX**

\* Load capacity max. 75 kg

**i**



When ordering a drawer cabinet from these two pages with **CODE Lock**, please add the suffix "**C**" or for **RFID** or **AUTO Lock** the suffix "**F**" or "**A**" to the article number from the table (e.g. **78.467.XXX.C**).

» Other locking systems see p. 28–31

**S** **LISTA quick delivery range**

These LISTA products in the colours light blue (.010) and light grey (.020) are available ex-works at short notice.

**.010** Light blue RAL 5012    **.020** Light grey RAL 7035



**S** Art. no. **18.205.010**  
Light blue, RAL 5012  
(excluding partition material)



Art. no. **13.106.200**  
Anthracite grey, RAL 7016  
(excluding partition material)

**36×36 E** **W** → 717 mm **D** ↗ 725 mm

 612×612 mm

**H** ↑ **Number of drawers mm**

  Art. no. 

<b>1000</b>	6: 1×50/3×150/2×200	75	KEY Lock	<b>14.417.XXX</b>
<b>1000</b>	6: 1×50*/3×150/2×200	200	KEY Lock	<b>14.510.XXX</b>
<b>1000</b>	6: 1×100/4×150/1×200	75	KEY Lock	<b>14.415.XXX</b>
<b>1000</b>	6: 1×100/4×150/1×200	200	KEY Lock	<b>14.509.XXX</b>
<b>1000</b>	7: 1×50/2×75/2×100/1×200/1×300	75	KEY Lock	<b>14.416.XXX</b>
<b>1000</b>	7: 1×50*/2×75/2×100/1×200/1×300	200	KEY Lock	<b>18.205.XXX</b>
<b>1000</b>	8: 1×50/2×75/2×100/2×150/1×200	75	KEY Lock	<b>14.414.XXX</b>
<b>1000</b>	8: 1×50*/2×75/2×100/2×150/1×200	200	KEY Lock	<b>14.508.XXX</b>
<b>1000</b>	8: 2×75/3×100/3×150	75	KEY Lock	<b>14.412.XXX</b>
<b>1000</b>	8: 2×75/3×100/3×150	200	KEY Lock	<b>14.506.XXX</b>
<b>1000</b>	9: 9×100	75	KEY Lock	<b>78.648.XXX</b>
<b>1000</b>	9: 9×100	200	KEY Lock	<b>78.650.XXX</b>
<b>1000</b>	10: 1×50/2×75/7×100	75	KEY Lock	<b>14.413.XXX</b>
<b>1000</b>	10: 1×50*/2×75/7×100	200	KEY Lock	<b>14.507.XXX</b>
<b>1450</b>	9: 2×75/2×100/2×150/2×200/1×300	75	KEY Lock	<b>78.309.XXX</b>
<b>1450</b>	9: 2×75/2×100/2×150/2×200/1×300	200	KEY Lock	<b>14.511.XXX</b>
<b>1450</b>	9: 3×100/5×150/1×300	75	KEY Lock	<b>78.311.XXX</b>
<b>1450</b>	9: 3×100/5×150/1×300	200	KEY Lock	<b>13.106.XXX</b>
<b>1450</b>	10: 1×50/5×100/4×200	75	KEY Lock	<b>78.313.XXX</b>
<b>1450</b>	10: 1×50*/5×100/4×200	200	KEY Lock	<b>14.512.XXX</b>
<b>890</b>	3: 1×100/1×200/1×300	200	KEY Lock	<b>69.927.XXX</b>
<b>890</b>	5: 1×50/2×100/1×150/1×200	75	KEY Lock	<b>69.928.XXX</b>
<b>890</b>	6: 2×75/3×100/1×150	75	KEY Lock	<b>69.929.XXX</b>
<b>957</b>	5: 1×50/2×100/1×150/1×200	75	KEY Lock	<b>78.652.XXX</b>
<b>1107</b>	7: 2×75/2×100/2×125/1×150	75	KEY Lock	<b>78.666.XXX</b>
<b>1107</b>	8: 4×75/3×100/1×150	75	KEY Lock	<b>78.668.XXX</b>

**S**  
**S**  
**S**  
**S**  
**S**  
**S**

### Mobile cabinets

All mobile drawer cabinets on this page are equipped with:  
1 raised edge on 4 sides and ribbed mat,  
1 push-bar,  
1 pair castor holders with rubber castors  
Ø 160 mm, Drawer safety catch on right,  
Load capacity 600 kg

For height 890 mm:  
Rubber castors Ø 100 mm, capacity 400 kg

**S**  
**S**



Art. no. **78.668.090**  
Gentian blue, RAL 5010  
(excluding partition material)



# Drawer cabinets | stationary



Art. no. **78.682.519**  
Housing: Light grey, RAL 7035  
Fronts: Metallic grey, NCS S 6502-B  
(excluding partition material)

**45 × 36 E**

**W → 870 mm**

**D ↗ 725 mm**

 765 × 612 mm



H ↑	Number of drawers mm	kg	Locking system	Art. no.
850	7: 1 × 50/2 × 75/2 × 100/1 × 150/1 × 200	75	KEY Lock	<b>78.686.XXX</b>
850	7: 1 × 50*/2 × 75/2 × 100/1 × 150/1 × 200	200	KEY Lock	<b>78.688.XXX</b>
850	7: 2 × 75/2 × 100/2 × 125/1 × 150	75	KEY Lock	<b>78.690.XXX</b>
850	7: 2 × 75/2 × 100/2 × 125/1 × 150	200	KEY Lock	<b>78.692.XXX</b>
850	8: 4 × 75/3 × 100/1 × 150	75	KEY Lock	<b>78.682.XXX</b>
850	8: 4 × 75/3 × 100/1 × 150	200	KEY Lock	<b>78.684.XXX</b>
1000	7: 1 × 50/2 × 75/2 × 100/1 × 200/1 × 300	75	KEY Lock	<b>78.694.XXX</b>
1000	7: 1 × 50*/2 × 75/2 × 100/1 × 200/1 × 300	200	KEY Lock	<b>78.696.XXX</b>
1000	8: 1 × 50/2 × 75/3 × 100/1 × 150/1 × 250**	75	KEY Lock	<b>78.698.XXX</b>
1000	8: 1 × 50*/2 × 75/3 × 100/1 × 150/1 × 250	200	KEY Lock	<b>78.700.XXX</b>
1000	8: 3 × 50/2 × 75/2 × 100/1 × 150/1 × 250**	75	KEY Lock	<b>78.702.XXX</b>
1000	8: 3 × 50*/2 × 75/2 × 100/1 × 150/1 × 250	200	KEY Lock	<b>78.704.XXX</b>
1450	9: 3 × 100/5 × 150/1 × 300**	75	KEY Lock	<b>78.706.XXX</b>
1450	9: 3 × 100/5 × 150/1 × 300	200	KEY Lock	<b>78.708.XXX</b>
1450	9: 9 × 150	75	KEY Lock	<b>78.710.XXX</b>
1450	9: 9 × 150	200	KEY Lock	<b>78.712.XXX</b>
1450	13: 4 × 75/6 × 100/3 × 150	75	KEY Lock	<b>78.714.XXX</b>
1450	13: 4 × 75/6 × 100/3 × 150	200	KEY Lock	<b>78.716.XXX</b>

\* Load capacity max. 75 kg

\*\* Load capacity 200 kg

**i**



When ordering a drawer cabinet from these two pages with **CODE Lock**, please add the suffix "**C**" or for **RFID** or **AUTO Lock** the suffix "**F**" or "**A**" to the article number from the table (e.g. **78.467.XXX.C**).

» Other locking systems see p. 28–31



Art. no. **78.716.010**  
Light blue, RAL 5012  
(excluding partition material)





Art. no. **78.297.280.C**  
Orange, RAL 2004  
(excl. partition material)

**54 × 36 E**

**W** → 1023 mm

**D** ↗ 725 mm

918 × 612 mm



**H** ↑ Number of drawers mm

kg Lock Art. no.

<b>850</b>	5: 3 × 100 / 1 × 150 / 1 × 300**	75	KEY Lock	<b>78.796.XXX</b>
<b>850</b>	5: 3 × 100 / 1 × 150 / 1 × 300	200	KEY Lock	<b>78.798.XXX</b>
<b>850</b>	6: 2 × 75 / 2 × 100 / 1 × 150 / 1 × 250**	75	KEY Lock	<b>78.800.XXX</b>
<b>850</b>	6: 2 × 75 / 2 × 100 / 1 × 150 / 1 × 250	200	KEY Lock	<b>78.802.XXX</b>
<b>850</b>	7: 1 × 50 / 2 × 75 / 2 × 100 / 1 × 150 / 1 × 200	75	KEY Lock	<b>78.804.XXX</b>
<b>850</b>	7: 1 × 50* / 2 × 75 / 2 × 100 / 1 × 150 / 1 × 200	200	KEY Lock	<b>78.806.XXX</b>
<b>1000</b>	5: 2 × 100 / 2 × 200 / 1 × 300**	75	KEY Lock	<b>79.390.XXX</b>
<b>1000</b>	5: 2 × 100 / 2 × 200 / 1 × 300	200	KEY Lock	<b>79.392.XXX</b>
<b>1000</b>	6: 1 × 100 / 4 × 150 / 1 × 200	75	KEY Lock	<b>78.291.XXX</b>
<b>1000</b>	6: 1 × 100 / 4 × 150 / 1 × 200	200	KEY Lock	<b>14.515.XXX</b>
<b>1000</b>	7: 1 × 50 / 2 × 75 / 2 × 100 / 1 × 200 / 1 × 300**	75	KEY Lock	<b>78.292.XXX</b>
<b>1000</b>	7: 1 × 50* / 2 × 75 / 2 × 100 / 1 × 200 / 1 × 300	200	KEY Lock	<b>14.516.XXX</b>
<b>1000</b>	8: 1 × 50 / 2 × 75 / 2 × 100 / 2 × 150 / 1 × 200	75	KEY Lock	<b>78.293.XXX</b>
<b>1000</b>	8: 1 × 50* / 2 × 75 / 2 × 100 / 2 × 150 / 1 × 200	200	KEY Lock	<b>12.541.XXX</b>
<b>1000</b>	8: 2 × 75 / 3 × 100 / 3 × 150	75	KEY Lock	<b>78.294.XXX</b>
<b>1000</b>	8: 2 × 75 / 3 × 100 / 3 × 150	200	KEY Lock	<b>14.513.XXX</b>
<b>1000</b>	10: 1 × 50 / 2 × 75 / 7 × 100	75	KEY Lock	<b>78.295.XXX</b>
<b>1000</b>	10: 1 × 50* / 2 × 75 / 7 × 100	200	KEY Lock	<b>14.514.XXX</b>
<b>1450</b>	9: 2 × 75 / 2 × 100 / 2 × 150 / 2 × 200 / 1 × 300**	75	KEY Lock	<b>78.296.XXX</b>
<b>1450</b>	9: 2 × 75 / 2 × 100 / 2 × 150 / 2 × 200 / 1 × 300	200	KEY Lock	<b>12.550.XXX</b>
<b>1450</b>	9: 3 × 100 / 5 × 150 / 1 × 300**	75	KEY Lock	<b>78.297.XXX</b>
<b>1450</b>	9: 3 × 100 / 5 × 150 / 1 × 300	200	KEY Lock	<b>14.518.XXX</b>
<b>1450</b>	10: 1 × 50 / 5 × 100 / 4 × 200	75	KEY Lock	<b>78.298.XXX</b>
<b>1450</b>	10: 1 × 50* / 5 × 100 / 4 × 200	200	KEY Lock	<b>14.519.XXX</b>

**S**

**LISTA quick delivery range**

These LISTA products in the colours light blue (.010) and light grey (.020) are available ex-works at short notice.

**.010**

Light blue  
RAL 5012

**.020**

Light grey  
RAL 7035

**S**

**S**

**S**

**S**

**S**

**S**

**S**

**S**

**S**

**S**

**S**

**S**



Art. no. **14.516.514**  
Housing: Light grey, RAL 7035  
Fronts: Light blue, RAL 5012  
(excluding partition material)



# Drawer cabinets | stationary



**64 × 36 E**

**W** → 1193 mm

**D** ↗ 725 mm

1088 × 612 mm



H	Number of drawers mm	Model	kg	Locking system	Art. no.
1000	7: 2 × 75 / 2 × 100 / 1 × 150** / 2 × 200**	-	75	KEY Lock	<b>78.826.XXX</b>
1000	7: 2 × 75 / 2 × 100 / 1 × 150 / 2 × 200	-	200	KEY Lock	<b>78.828.XXX</b>
1000	8: 2 × 75 / 4 × 100 / 1 × 150** / 1 × 200**	-	75	KEY Lock	<b>78.830.XXX</b>
1000	8: 2 × 75 / 4 × 100 / 1 × 150 / 1 × 200	-	200	KEY Lock	<b>78.832.XXX</b>
1000	8: 2 × 75 / 3 × 100 / 3 × 150**	-	75	KEY Lock	<b>78.834.XXX</b>
1000	8: 2 × 75 / 3 × 100 / 3 × 150	-	200	KEY Lock	<b>78.836.XXX</b>
1450	10: 2 × 150 / 1 × 125 / 1 × 75 / 3 × 100 / 1 × 150 / 2 × 200	-	200	KEY Lock	<b>78.838.XXX</b>
1450	11: 1 × 150 / 1 × 125 / 1 × 75 / 5 × 100 / 2 × 150 / 1 × 200	-	200	KEY Lock	<b>78.840.XXX</b>
1450	12: 1 × 150 / 1 × 125 / 3 × 75 / 5 × 100 / 1 × 150 / 1 × 200	-	200	KEY Lock	<b>78.842.XXX</b>
870	8: 1 × 200** (64E) / 2 × 150, 1 × 200 (36E) / 2 × 150, 2 × 100 (18E)	Multiplex top, 20 mm	75	KEY Lock	<b>69.562.XXX</b>



Art. no. **78.842.514**  
Housing: Light grey, RAL 7035  
Fronts: Light blue, RAL 5012  
(excluding partition material)



Art. no. **69.562.200**  
with Multiplex cover panel, 20 mm  
anthracite grey, RAL 7016

Toolbox  
see p. 72–73







Art. no. **78.868.512**  
 Housing: Light grey, RAL 7035  
 Fronts: Ruby red, RAL 3003  
 (excluding partition material)

**78×36 E**    **W** → 1431 mm    **D** ↗ 725 mm

 1326×612 mm



<b>H</b> ↑	Number of drawers	mm			Art. no. 
1000	5: 2×100 / 2×200**/ 1×300**	75	KEY	Lock	<b>79.492.XXX</b>
1000	5: 2×100 / 2×200 / 1×300	200	KEY	Lock	<b>79.494.XXX</b>
1000	7: 2×75/2×100/1×150**/2×200**	75	KEY	Lock	<b>78.856.XXX</b>
1000	7: 2×75/2×100/1×150/2×200	200	KEY	Lock	<b>78.858.XXX</b>
1000	8: 2×75/4×100/1×150**/1×200**	75	KEY	Lock	<b>78.860.XXX</b>
1000	8: 2×75/4×100/1×150/1×200	200	KEY	Lock	<b>78.862.XXX</b>
1450	10: 2×150 / 1×125 / 1×75 / 3×100 / 1×150 / 2×200	200	KEY	Lock	<b>78.868.XXX</b>
1450	11: 1×150 / 1×125 / 1×75 / 5×100 / 2×150 / 1×200	200	KEY	Lock	<b>78.870.XXX</b>
1450	12: 1×150 / 1×125 / 3×75 / 5×100 / 1×150 / 1×200	200	KEY	Lock	<b>78.872.XXX</b>

**i** 

When ordering a drawer cabinet from these two pages with **CODE Lock**, please add the suffix "**C**" or for **RFID** or **AUTO Lock** the suffix "**F**" or "**A**" to the article number from the table (e.g. **78.467.XXX.C**).

➤ Other locking systems see p. 28–31

# Drawer cabinets | freely configurable

## 1. Cabinet housing with locking systems

To lock all drawers simultaneously, the cabinet housing can be customised with the electronic KEY Lock, CODE Lock, RFID Lock or AUTO Lock.



Housing with KEY Lock



Housing with CODE Lock



Housing with RFID Lock



Housing with AUTO Lock

**i** When ordering a cabinet with **CODE Lock**, please add the suffix "**C**" or for **RFID** or **AUTO Lock** the suffix "**F**" or "**A**" to the article number from the table (e.g. **71.088.XXX.C**).

» Other locking systems:  
see p. 28–31

		Depth 27 E			
LISTA Units		18 × 27 E	27 × 27 E	36 × 27 E	54 × 27 E
Cabinet floor area mm		411 × 572 mm	564 × 572 mm	717 × 572 mm	1023 × 572 mm
<b>W</b> → × <b>D</b> ↗					
<b>H</b> ↑	Clear Height mm	Art. no.	Art. no.	Art. no.	Art. no.
283	200	71.059.XXX	71.070.XXX	-	-
383	300	71.060.XXX	71.071.XXX	-	-
533	450	71.061.XXX	71.072.XXX	-	-
650	550	71.062.XXX	71.073.XXX	○	○
700	600	71.063.XXX	71.074.XXX	71.086.XXX	71.102.XXX
800	700	○	71.075.XXX	○	○
850	750	71.401.XXX	71.076.XXX	71.087.XXX	71.103.XXX
1000	900	71.064.XXX	71.077.XXX	71.088.XXX	71.104.XXX
1150	1050	○	○	○	○
1325	1225	○	○	○	○
1450	1350	○	○	71.089.XXX	71.105.XXX
1625	1525	○	○	○	○

○ = on request

## 2. Drawers

Drawers with different front heights can be incorporated into the same cabinet housing in any order. The insides of the drawer walls are all fitted with a slotted grid in units (E) of 17 mm, which means each drawer can be partitioned as required.



### Drawer safety catches

**Standard:** standard model including single drawer safety catch (all article numbers from the table).

**Safety catch on right:** the minimum requirement for mobile drawer cabinets. One-sided drawer safety catch on the right can be released with one hand and prevents accidental opening of drawers even if the cabinet is unlocked.

**i** When ordering a **single safety catch on the right**, please add the suffix "**R**" to the article number in the table (e.g. **72.034.XXX.R**).

### Ordering tips

When selecting drawers, the clear height of the cabinet housing defines the size. The sum of the drawer front heights (C) must be equal to the clear height (B) (see diagram).

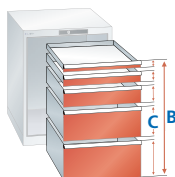

## 3. For further accessories

» see next page

## 4. Partition material

for drawers

» see p. 248

		LISTA Units			
		18 × 27 E	27 × 27 E	36 × 27 E	54 × 27 E
	<b>75 kg</b> Load capacity				
Drawer usable surface mm		306 × 459 mm	459 × 459 mm	612 × 459 mm	918 × 459 mm
<b>W</b> → × <b>D</b> ↗					
<b>H</b> ↑	Usable height mm	Art. no.	Art. no.	Art. no.	Art. no.
50*	32,5	72.000.XXX	72.012.XXX	72.042.XXX	72.080.XXX
75	57,5	72.001.XXX	72.013.XXX	72.043.XXX	72.505.XXX
100	82,5	72.002.XXX	72.015.XXX	72.045.XXX	72.506.XXX
125	107,5	-	72.017.XXX	72.047.XXX	72.507.XXX
150	132,5	72.003.XXX	72.019.XXX	72.049.XXX	72.508.XXX
200	182,5	72.004.XXX	72.021.XXX	72.051.XXX	72.509.XXX
250	232,5	-	72.023.XXX	72.053.XXX	-
300	282,5	72.005.XXX	72.025.XXX	72.055.XXX	-

\* Drawers with a front height of 50 mm must be placed in the top position

	<b>200 kg</b> Load capacity					
75	57,5	49	-	72.014.XXX	72.044.XXX	72.081.XXX
100	82,5	76	-	72.016.XXX	72.046.XXX	72.082.XXX
125	107,5	76	-	72.018.XXX	72.048.XXX	72.083.XXX
150	132,5	126	-	72.020.XXX	72.050.XXX	72.084.XXX
200	182,5	176	-	72.022.XXX	72.052.XXX	72.085.XXX
250	232,5	226	-	72.024.XXX	72.054.XXX	72.086.XXX
300	282,5	276	-	72.026.XXX	72.056.XXX	72.087.XXX

For filling and loading the drawers and drawer cabinets, please follow the installation manual and the loading guidelines. Load capacity applies to evenly distributed load.

Depth 36 E

18 × 36 E	27 × 36 E	36 × 36 E	45 × 36 E	54 × 36 E	64 × 36 E	78 × 36 E
411 × 725 mm	564 × 725 mm	717 × 725 mm	870 × 725 mm	1023 × 725 mm	1193 × 725 mm	1431 × 725 mm
Art. no.	Art. no.	Art. no.	Art. no.	Art. no.	Art. no.	Art. no.
71.065.XXX	71.078.XXX	-	-	-	-	-
71.066.XXX	71.079.XXX	-	-	-	-	-
71.067.XXX	71.080.XXX	-	-	-	-	-
71.068.XXX	71.081.XXX	○	○	○	○	○
71.069.XXX	71.082.XXX	71.090.XXX	71.098.XXX	71.106.XXX	71.110.XXX	71.114.XXX
○	71.083.XXX	71.091.XXX	○	○	○	○
71.407.XXX	71.084.XXX	71.092.XXX	71.099.XXX	71.107.XXX	71.416.XXX	71.421.XXX
71.408.XXX	71.085.XXX	71.093.XXX	71.100.XXX	71.108.XXX	71.111.XXX	71.115.XXX
○	○	71.094.XXX	○	○	○	○
○	○	71.095.XXX	○	○	71.112.XXX	71.116.XXX
○	○	71.096.XXX	71.101.XXX	71.109.XXX	71.113.XXX	71.117.XXX
○	○	71.097.XXX	○	○	○	○

18 × 36 E	27 × 36 E	36 × 36 E	45 × 36 E	54 × 36 E	64 × 36 E	78 × 36 E
306 × 612 mm	459 × 612 mm	612 × 612 mm	765 × 612 mm	918 × 612 mm	1088 × 612 mm	1326 × 612 mm
Art. no.	Art. no.	Art. no.	Art. no.	Art. no.	Art. no.	Art. no.
72.006.XXX	72.027.XXX	72.057.XXX	72.072.XXX	72.088.XXX	72.805.XXX	72.806.XXX
72.007.XXX	72.028.XXX	72.058.XXX	72.540.XXX	72.510.XXX	72.515.XXX	72.517.XXX
72.008.XXX	72.030.XXX	72.060.XXX	72.541.XXX	72.511.XXX	72.516.XXX	72.518.XXX
-	72.032.XXX	72.062.XXX	72.542.XXX	72.512.XXX	-	-
72.009.XXX	72.034.XXX	72.064.XXX	72.543.XXX	72.513.XXX	-	-
72.010.XXX	72.036.XXX	72.066.XXX	72.544.XXX	72.514.XXX	-	-
-	72.038.XXX	72.068.XXX	-	-	-	-
72.011.XXX	72.040.XXX	72.070.XXX	-	-	-	-
-	72.029.XXX	72.059.XXX	72.073.XXX	72.089.XXX	72.096.XXX	72.103.XXX
-	72.031.XXX	72.061.XXX	72.074.XXX	72.090.XXX	72.097.XXX	72.104.XXX
-	72.033.XXX	72.063.XXX	72.075.XXX	72.091.XXX	72.098.XXX	72.105.XXX
-	72.035.XXX	72.065.XXX	72.076.XXX	72.092.XXX	72.099.XXX	72.106.XXX
-	72.037.XXX	72.067.XXX	72.077.XXX	72.093.XXX	72.100.XXX	72.107.XXX
-	72.039.XXX	72.069.XXX	72.078.XXX	72.094.XXX	72.101.XXX	72.108.XXX
-	72.041.XXX	72.071.XXX	72.079.XXX	72.095.XXX	72.102.XXX	72.109.XXX



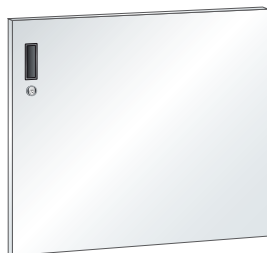

## Recessed hinged doors for pull-out and adjustable shelves

Made from sheet steel as a front closing option for the pull-out and adjustable shelves built into the housing beneath the drawers. Equipped with a recessed grip and magnetic catch incl. KEY Lock. The sum of the hinged door front heights and all drawer front heights must be equal to the clear height of the cabinet housing.

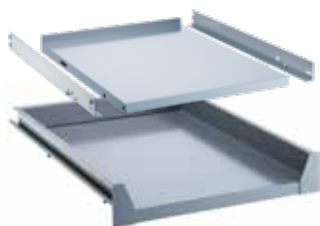

## Pull-out and adjustable shelves for recessed doors

Made from steel sheet, pigeon grey, NCS S 4502-B. Load capacity of pull-out shelf 75 kg, adjustable shelf 200 kg. Thanks to the 25 mm increments in the vertical supports of the cabinet housings, different shelves can be fitted in the same housing in any order.



## Raised edges on 3 sides and ribbed mat

Made from sheet steel, black, NCS S 9000-N, including ribbed mat, black.



## Cover panel, resin-coated

Surface and edging light grey, NCS S 1500-N, laminated chipboard (quality class E1), with melamine coating on both sides (manufactured according to standard EN 14322). 2 mm thick plastic edging on all sides. Including pre-drilled holes and fastening material.



## Multiplex cover panel

Made of steamed beech veneers, glued in multiple layers and waterproof (DIN 68 705), bevelled edges, sanded, oiled and waxed surface. The panel is splash-proof, dirt-repellent and largely impervious to oil and grease. Including pre-drilled holes and fastening material.



## Folding countertop

Attaches to the side of the drawer cabinet (depth 27E). It can be mounted either on one side or on both drawer cabinet edges and offers a work surface up to 1000 mm (2 x 500 mm) wider. It is operated one-handed. Multiplex top, sanded, oiled and waxed surface. Load capacity 25 kg, Housing incl. 10 x 10 square perforation, 38 mm divisions with slots, for cabinet height 850 mm.



## Push bar

This push bar can be mounted for the mobile version of drawer cabinets without raised edges in the transverse direction of travel. Galvanised steel, Ø 22 mm, curved.

Depth 27 E

LISTA Units

18 x 27 E

27 x 27 E

### Hinged doors, recessed\*

	Art. no.	Art. no.
Mounted on the right H 450 mm	74.110.XXX	74.112.XXX
Mounted on the right H 600 mm	74.111.XXX	74.113.XXX
Mounted on the right H 750 mm	340.166.XXX	338.736.XXX
Mounted on the left H 450 mm	74.122.XXX	74.126.XXX
Mounted on the left H 600 mm	74.123.XXX	74.127.XXX
Mounted on the left H 750 mm	340.999.XXX	338.737.XXX
+ cylinders with different keys	222.376.000	

\* without cylinder; please order this separately

### Adjustable shelf, H 75 mm

	74.005.000	74.009.000
Usable dimensions (W x D mm)	350 x 465	503 x 465

### Pull-out shelf, H 100 mm

	74.004.000	74.008.000
Usable dimensions (W x D mm)	281 x 459	434 x 459

### Raised edge with ribbed mat

	74.023.000	74.025.000
Dimensions (W x D x H mm)	411 x 572 x 20	564 x 572 x 20

### Ribbed mat only

	74.012.000	74.014.000
Dimensions (W x D x H mm)	406 x 567 x 3	559 x 567 x 3

### Resin-coated cover panel

	74.140.000	17.268.000
Dimensions (W x D x H mm)	411 x 572 x 22	564 x 572 x 22

### Multiplex cover panel

	12.590.000	12.592.000
Dimensions (W x D x H mm)	411 x 572 x 20	564 x 572 x 20

### Folding countertop

	69.555.XXX	69.555.XXX
Dimensions for folded module	86 x 571 x 880	86 x 571 x 880
Dimensions of top (W x D x H mm)	500 x 565 x 20	500 x 565 x 20

### Push bar

	-	12.610.000
Width mm		399

\*depending on the properties of the floor.

www.lista.com

Depth 27 E		Depth 36 E						
36 × 27 E	54 × 27 E	18 × 36 E	27 × 36 E	36 × 36 E	45 × 36 E	54 × 36 E	64 × 36 E	78 × 36 E
Art. no.  74.128.XXX	Art. no. -	Art. no.  74.110.XXX	Art. no.  74.112.XXX	Art. no.  74.128.XXX	Art. no. -	Art. no. -	Art. no. -	Art. no. -
74.129.XXX	-	74.111.XXX	74.113.XXX	74.129.XXX	-	-	-	-
338.735.XXX	-	340.166.XXX	338.736.XXX	338.735.XXX	-	-	-	-
74.130.XXX	-	74.122.XXX	74.126.XXX	74.130.XXX	-	-	-	-
74.131.XXX	-	74.123.XXX	74.127.XXX	74.131.XXX	-	-	-	-
340.048.XXX	-	340.999.XXX	338.737.XXX	340.048.XXX	-	-	-	-
222.376.000	-		222.376.000		-	-	-	-
74.105.000 656 × 465	-	74.007.000 350 × 618	74.011.000 503 × 618	74.106.000 656 × 618	-	-	-	-
-	-	74.006.000 281 × 612	74.010.000 434 × 612	342.371.080 587 × 612	-	-	-	-
74.027.000 717 × 572 × 20	74.030.000 1023 × 572 × 20	74.024.000 411 × 725 × 20	74.026.000 564 × 725 × 20	74.028.000 717 × 725 × 20	74.029.000 870 × 725 × 20	74.031.000 1023 × 725 × 20	74.032.000 1193 × 725 × 20	74.033.000 1431 × 725 × 20
74.016.000 712 × 567 × 3	74.019.000 1018 × 567 × 3	74.013.000 406 × 720 × 3	74.015.000 559 × 720 × 3	74.017.000 712 × 720 × 3	74.018.000 865 × 720 × 3	74.020.000 1018 × 720 × 3	74.021.000 1188 × 720 × 3	74.022.000 1426 × 720 × 3
17.270.000 717 × 572 × 22	74.143.000 1023 × 572 × 22	74.141.000 411 × 725 × 22	17.269.000 564 × 725 × 22	17.271.000 717 × 725 × 22	74.142.000 870 × 725 × 22	74.144.000 1023 × 725 × 22	74.145.000 1193 × 725 × 22	74.146.000 1431 × 725 × 22
12.594.000 717 × 572 × 20	12.597.000 1023 × 572 × 20	12.591.000 411 × 725 × 20	12.593.000 564 × 725 × 20	12.595.000 717 × 725 × 20	12.596.000 870 × 725 × 20	12.598.000 1023 × 725 × 20	12.599.000 1193 × 725 × 20	12.600.000 1431 × 725 × 20
69.555.XXX 86 × 571 × 880 500 × 565 × 20	69.555.XXX 86 × 571 × 880 500 × 565 × 20	-	-	-	-	-	-	-
12.610.000 399	12.610.000 399	12.611.000 552	12.611.000 552	12.611.000 552	12.611.000 552	12.611.000 552	12.611.000 552	12.611.000 552



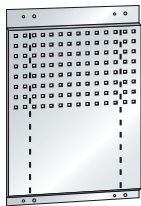

## Perforated side panel

To allow accessories (waste container, protective earth socket retaining bracket) or keyhole hooks to be attached to the side of the drawer cabinet (depth 27 E), this perforated plate can be fastened to the side of the housing cabinet. Square perforation 10 × 10, 38 mm divisions with slots. Design for housing height 850 mm. Sheet steel design. Colour: as per colour chart.



## Housing base

Made from sheet steel, as height compensation, black, NCS S 9000-N.



## 2-way pallet/forklift truck base

Made from sheet steel for screwing to the underside of the housing, black, NCS S 9000-N. **Base cover only** for attaching as a cover on the front or rear.



## Raised edges on 4 sides, with push-bar

Made from sheet steel, black, NCS S 9000-N, including ribbed mat, black. Push-bar consisting of a pair of plastic handle grips, RAL 9006 white aluminium, and aluminium tube Ø 25 mm, clear anodised.



## Pair of castor holders

Consisting of 2 swivel castors with brakes and 2 fixed castors. Castor holders, sendzimir galvanised. Nylon castors black, rubber castors grey.

**!** For safety reasons, mobile drawer cabinets must be fitted with a push-bar and a single drawer safety catch.

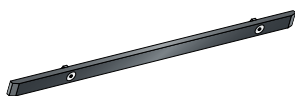

## Protective strip

Made of black polythene, including fastening screws for mounting on the sides of the drawer cabinet. Two protective strips must be attached to each side.

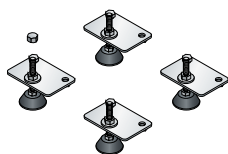

## Levelling foot set

Set consisting of 4 plastic pivot feet, Ø 50 mm, including mounting plates and fastening screws. Adjustment range: 45 – 90 mm. Load capacity: 1200 kg/foot. Art. no. **69.919.000**



## Levelling foot set for cover plates

Set consisting of 2 pairs of levelling feet (4 plastic articulated feet), Ø 50 mm, mounting plates designed for the levelling foot holder, incl. fastening screws. Adjustment range 45–90 mm. Load capacity 1200 kg/foot

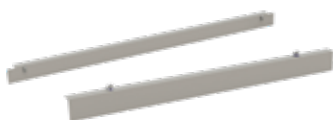

## Levelling foot covers

made of sheet steel, powder-coated white aluminium RAL 9006. Cover plate height 50 mm. Prevents small parts from getting under the cabinet. Closed look. The levelling foot set (69.920.000 or 69.921.000) is required for assembly. Cover plate can also be retrofitted afterwards.

	Depth 27 E	
LISTA Units	18 × 27 E	27 × 27 E
	Art. no.	Art. no.
<b>Perforated side panel</b>	-	<b>69.552.000</b>
Dimensions (H × D mm)		755 × 570
<b>Housing base, H 50 mm</b>	<b>74.045.000</b>	<b>74.049.000</b>
Dimensions (W × D mm)	411 × 540	564 × 540
<b>Housing base, H 100 mm</b>	<b>74.046.000</b>	<b>74.050.000</b>
Dimensions (W × D mm)	411 × 540	564 × 540
<b>Base, without cover, H 100 mm</b>	-	-
Dimensions (W × D mm)		
<b>Cover only, H 100 mm</b>	-	-
<b>Raised edge, H 53 mm</b>	<b>74.034.000</b>	<b>74.036.000</b>
Dimensions (W × D mm)	411 × 572	564 × 572
Direction of travel	lengthwise	lengthwise
<b>with nylon castors*, Ø 100 mm</b>	<b>74.071.000</b>	<b>74.071.000</b>
H/Load capacity kg	137/400	137/400
Direction of travel	lengthwise	lengthwise
<b>with rubber castors* Ø 100 mm</b>	<b>74.072.000</b>	<b>74.072.000</b>
H/Load capacity kg	137/400	137/400
Direction of travel	lengthwise	lengthwise
<b>with rubber castors*, Ø 160 mm</b>	-	<b>74.075.000</b>
H/Load capacity kg		204/600
Direction of travel		lengthwise
<b>Protective strip</b>	<b>333.888.000</b>	
Length (mm)	567	
<b>i Note:</b>	Can only be used in combination with housings with a height of 700 mm.	
<b>Levelling foot set for cover plates</b>	<b>69.920.000</b>	
<b>Side cover plates</b>	<b>69.847.130</b>	
<b>Front cover plates</b>	<b>69.840.130</b>	<b>69.841.130</b>



Depth 27 E			Depth 36 E						
36 × 27 E		54 × 27 E	18 × 36 E	27 × 36 E	36 × 36 E	45 × 36 E	54 × 36 E	64 × 36 E	78 × 36 E
Art. no.	Art. no.	Art. no.	Art. no.	Art. no.	Art. no.	Art. no.	Art. no.	Art. no.	Art. no.
<b>69.552.000</b> 755 × 570	-	<b>69.552.000</b> 755 × 570	-	-	-	-	-	-	-
<b>74.053.000</b> 717 × 540	-	<b>74.057.000</b> 1023 × 540	<b>74.047.000</b> 411 × 693	<b>74.051.000</b> 564 × 693	<b>74.055.000</b> 717 × 693	<b>74.056.000</b> 870 × 693	<b>74.058.000</b> 1023 × 693	<b>74.059.000</b> 1193 × 693	<b>74.060.000</b> 1431 × 693
<b>74.054.000</b> 717 × 540	-	-	<b>74.048.000</b> 411 × 693	<b>74.052.000</b> 564 × 693	-	-	-	-	-
<b>74.061.000</b> 717 × 506	-	<b>74.064.000</b> 1023 × 506	-	<b>74.410.000</b> 564 × 659	<b>74.062.000</b> 717 × 659	<b>74.063.000</b> 870 × 659	<b>74.065.000</b> 1023 × 659	<b>74.065.000</b> 1193 × 659	<b>74.065.000</b> 1431 × 659
<b>74.066.000</b>	-	<b>74.068.000</b>	-	<b>74.411.000</b>	<b>74.066.000</b>	<b>74.067.000</b>	<b>74.068.000</b>	<b>74.069.000</b>	<b>74.070.000</b>
<b>74.038.000</b> 717 × 572 crosswise	<b>74.158.000</b> 717 × 572 lengthwise	<b>74.041.000</b> 1023 × 572 crosswise	<b>74.035.000</b> 411 × 725 lengthwise	<b>74.037.000</b> 564 × 725 lengthwise	<b>74.039.000</b> 717 × 725 lengthwise	<b>74.040.000</b> 870 × 725 crosswise	<b>74.042.000</b> 1023 × 725 crosswise	<b>74.043.000</b> 1193 × 725 crosswise	<b>74.044.000</b> 1431 × 725 crosswise
<b>74.077.000</b> 137/400 crosswise	<b>74.071.000</b> 137/400 lengthwise	<b>74.077.000</b> 137/400 crosswise	<b>74.073.000</b> 137/400 lengthwise	<b>74.073.000</b> 137/400 lengthwise	<b>74.073.000</b> 137/400 lengthwise	<b>74.080.000</b> 137/400 crosswise	<b>74.080.000</b> 137/400 crosswise	<b>74.080.000</b> 137/400 crosswise	<b>74.080.000</b> 137/400 crosswise
<b>74.078.000</b> 137/400 crosswise	<b>74.072.000</b> 137/400 lengthwise	<b>74.078.000</b> 137/400 crosswise	<b>74.074.000</b> 137/400 lengthwise	<b>74.074.000</b> 137/400 lengthwise	<b>74.074.000</b> 137/400 lengthwise	<b>74.081.000</b> 137/400 crosswise	<b>74.081.000</b> 137/400 crosswise	<b>74.081.000</b> 137/400 crosswise	<b>74.081.000</b> 137/400 crosswise
<b>74.079.000</b> 204/600 crosswise	<b>74.075.000</b> 204/600 lengthwise	<b>74.079.000</b> 204/600 crosswise	-	<b>74.076.000</b> 204/600 lengthwise	<b>74.076.000</b> 204/600 lengthwise	<b>74.082.000</b> 204/600 crosswise	<b>74.082.000</b> 204/600 crosswise	<b>74.082.000</b> 204/600 crosswise	<b>74.082.000</b> 204/600 crosswise
	<b>333.888.000</b> 567					<b>323.434.000</b> 720			
	<b>69.920.000</b>					<b>69.921.000</b>			
	<b>69.847.130</b>					<b>69.848.130</b>			
<b>69.842.130</b>	<b>69.844.130</b>	<b>69.840.130</b>	<b>69.841.130</b>	<b>69.842.130</b>	<b>69.843.130</b>	<b>69.844.130</b>	<b>69.845.130</b>	<b>69.846.130</b>	<b>69.846.130</b>



**Drawer cabinets with a power supply are perfect for the centralised supply of rechargeable batteries and electrical devices.** All cabinets can be configured individually and adapted to your specific storage needs through the flexible use of partition material, cabinet accessories and power supply via power modules.

**+ Flexible range of applications**  
with charging options for battery-operated electrical machines, BDE devices, notebooks, tablets and smartphones

**+ Perfect cable management**  
via cable openings (punch-outs) for protected and orderly cable routing

**+ Great design diversity**  
with sockets, on/off switch, power USB

**+ Outstanding safety features**  
CE compliant

**>> General benefits of LISTA drawer cabinets**  
see p.38/39



## 1. Cabinet housing

Housing incl. punch-outs for power supply, incl. cable harness, excl. connection cable with earthing (must be ordered separately according to the lower version). For simultaneous securing of all drawers. Incl. KEY Lock, our standard locking system with replaceable cylinders. Manual opening/locking with key.



**i** When ordering a cabinet with **CODE Lock**, please add the suffix "C" or for **RFID** or **AUTO Lock** the suffix "F" or "A" to the article number from the table (e.g. 74.915.XXX.C).

» Other locking systems: see p. 28–31

LISTA Units		36 × 27 E	36 × 36 E
Cabinet floor area mm		717 × 572 mm	717 × 725 mm
<b>W</b> → × <b>D</b> ↗			
<b>H</b> ↑ mm	Clear Height mm	Art. no.	Art. no.
700	600	74.913.XXX	74.917.XXX
800	700	-	74.918.XXX
850	750	74.914.XXX	74.919.XXX
1000	900	74.915.XXX	74.920.XXX
1150	1050	-	74.921.XXX
1325	1225	-	74.922.XXX
1450	1350	74.916.XXX	74.923.XXX
1625	1525	-	74.924.XXX
»	Cabinet accessories, see from page 62	»	Partition material see from page 248

## 2. Drawers

Drawers with different front heights can be incorporated into the same cabinet housing in any order. The insides of the drawer walls are all fitted with a slotted grid in units (E) of 17 mm, which means each drawer can be partitioned as required.

### Ordering tips

When selecting drawers, the clear height of the cabinet housing defines the size. The sum of the drawer front heights (C) must be equal to the clear height (B) (see diagram).

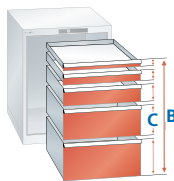

\* Drawers with front height of 50 mm must be placed in the top position.



LISTA Units		36 × 27 E		36 × 36 E	
Drawer usable surface mm		612 × 459 mm		612 × 612 mm	
<b>W</b> → × <b>D</b> ↗					
<b>H</b> ↑ mm	Usable height mm	Shell height mm	Art. no.	Art. no.	Art. no.
			75 kg	200 kg	75 kg
					200 kg
Drawer load capacity					
'Standard' drawers without power supply					
50*	32,5	28,5	72.042.XXX	-	72.057.XXX
75	57,5	49	72.043.XXX	72.044.XXX	72.058.XXX
100	82,5	76	72.045.XXX	72.046.XXX	72.060.XXX
125	107,5	76	72.047.XXX	72.048.XXX	72.062.XXX
150	132,5	126	72.049.XXX	72.050.XXX	72.064.XXX
200	182,5	176	72.051.XXX	72.052.XXX	72.066.XXX
250	232,5	226	72.053.XXX	72.054.XXX	72.068.XXX
300	282,5	276	72.055.XXX	72.056.XXX	72.070.XXX
Drawers with power supply					
With hole cut-out for the assembly of 1 × power module, incl. cable guide, excl. connection cable (must be ordered separately according to the lower version).					
200	182,5	176	74.973.XXX	74.820.XXX	74.976.XXX
250	232,5	226	74.974.XXX	74.821.XXX	74.977.XXX
300	282,5	276	74.975.XXX	74.822.XXX	74.978.XXX

**!** Max. 3 drawers with power supply per cabinet.

## 3. Power supply

Power modules for drawers with power supply

<b>1</b>	<b>2</b>
<b>3</b>	<b>4</b>

Power modules	Art. no. D/PE	Art. no. CH	Art. no. F	Art. no. GB
<b>1</b>	89.535.000	-	89.536.000	89.537.000
<b>2</b>	-	89.595.000	-	-
<b>3</b>	89.531.000	-	89.532.000	89.533.000
<b>4</b>	89.385.000	89.389.000	89.386.000	89.387.000
Connecting cable				
Incl. earthing*, length 3 m.	74.912.000	74.937.000	74.912.000	74.950.000



**Bespoke workshop design to suit your line of work.** Workshop equipment from LISTA has been tried and tested thousands of times in diverse industries. The modular design and excellent quality ensure that LISTA applications fit perfectly, are durable and robust. Special industry requirements are consistently met.



**+ Modular system design concept**  
offering flexible configuration in terms of size, equipment, locks, colour, etc.

**+ Best industrial quality**  
by using high-quality materials with a high level of in-house production and a 10-year guarantee

**+ Fully compatible**  
with freely combinable modules, uniform and attractive look and feel consistent with your corporate design in all areas: workshop, warehouse, staff room, etc.

**+ EDGE design**  
More contouring for your workshop with an individual light signature

**>> Benefits of LISTA workshop add-on modules**  
see automotive workshop system brochure

## Typical vehicle workshop solutions

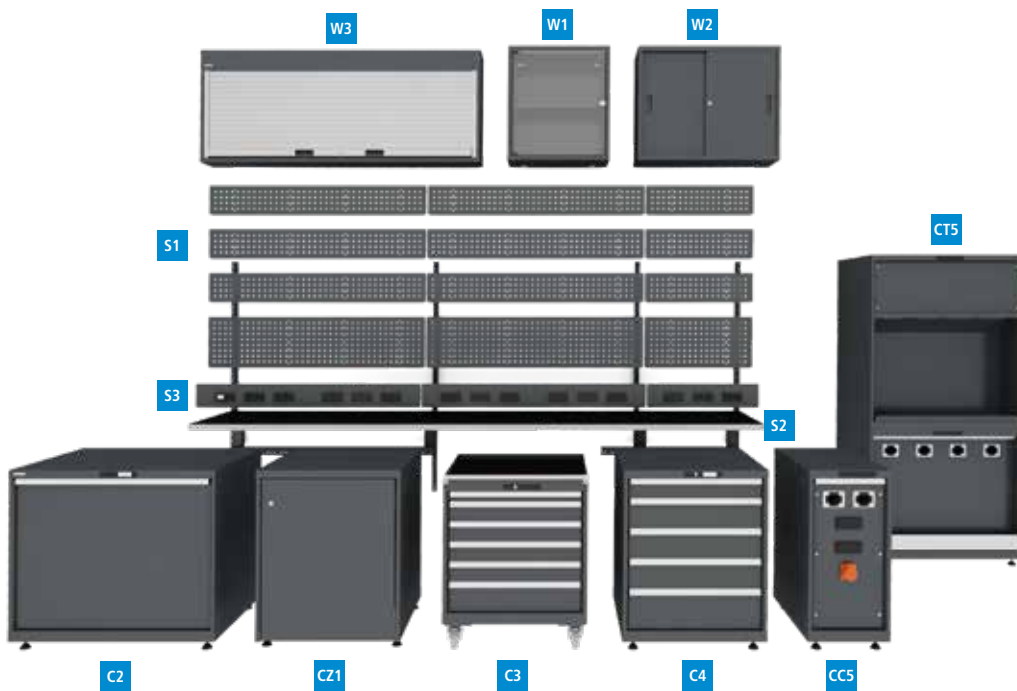

- CZ1** Accessible hinged-door cabinet
- C2** Disposal cabinet
- C3** Mobile drawer cabinet\*
- C4** Stationary drawer cabinet\*
- CC5** Media supply cabinet Compact
- CT5** Media supply tower
- S1** Perforated rear panel\*
- S2** Countertop\*
- S3** Power conduit\*
- W1** Monitor overhead cabinet\*
- W2** Overhead cabinet\*
- W3** Roller shutter overhead cabinet

\*See relevant chapter

### MRO solution I

Focused and flexible

#### Module combination

**CC5 C21 C2 S2 S3**

**W** → 2000 mm  
**D** ↗ 800 mm  
**H** ↑ 1100 mm



### MRO solution II

Ideal for a compact workshop solution

#### Module combination

**CC5 C3 C4 C2 S1 S2 S3**

**W** → 2360 mm  
**D** ↗ 860 mm  
**H** ↑ 1650 mm



### MRO solution III

Conceived for ambitious use

#### Module combination

**C5 CZ1 C2 C3 C4 S1 S2 S3 W1 W3**

**W** → 3445 mm  
**D** ↗ 860 mm  
**H** ↑ 1950 mm



### MRO solution IV

No compromises on function or ergonomics

#### Module combination

**C2 CZ1 C3 C4 CC5 CT5 S1 S2 S3 W1 W2 W3**

**W** → 4720 mm  
**D** ↗ 860 mm  
**H** ↑ 2000 mm





**64 × 27 E**

**W** → 1193 mm

**D** ↗ 572 mm



**H** ↑

**1090<sup>1</sup>** Toolbox mobile

**Number of drawers mm**

**64 E:** 2 × 100

**36 E:** 2 × 150, 1 × 200

**18 E:** 2 × 150, 2 × 100

Folding countertop

Multiplex cover panel, 30 mm

Perforated side panel

Perforated rear panel (usable height 360 mm)

Rubber castors, Ø 160 mm, incl. push handle

**kg**

75

**KEY Lock**

75

Art. no. 

**69.561.XXX**

75

75

25

**64 × 36 E**

**W** → 1193 mm

**D** ↗ 725 mm



**H** ↑

**870** Toolbox stationary

**Number of drawers mm**

**64 E:** 1 × 200

**36 E:** 2 × 150, 1 × 200

**18 E:** 2 × 150, 2 × 100

Multiplex cover panel, 20 mm

**kg**

200

**KEY Lock**

75

Art. no. 

**69.562.XXX**

75

75

<sup>1</sup> Height without perforated rear panel

**D** **725 mm**
**H** **850 mm** (without Levelling feet)

**C1 Hinged door cabinet**  
1 adjustable shelf  
Levelling foot set for cover plates (4 × feet)

Doors mounted		LISTA unit	Art. No.
right	411 mm	<b>18 × 36 E</b>	<b>69.941.XXX</b>
left	411 mm	<b>18 × 36 E</b>	<b>69.942.XXX</b>
right	564 mm	<b>27 × 36 E</b>	<b>69.943.XXX</b>
left	564 mm	<b>27 × 36 E</b>	<b>69.944.XXX</b>
right	717 mm	<b>36 × 36 E</b>	<b>69.945.XXX</b>
left	717 mm	<b>36 × 36 E</b>	<b>69.946.XXX</b>
right	717 mm	<b>36 × 36 E</b>	<b>69.903.XXX</b>
left	717 mm	<b>36 × 36 E</b>	<b>69.902.XXX</b>

**CZ1 Hinged door cabinet accessible**  
without floor, without threshold, levelling foot set for panels (4 × feet)



**C2 Disposal cabinet**  
Levelling foot set for cover plates (4 × feet)  
Pull-out drawer: completely powder-coated according to colour chart  
Load capacity: 200 kg

Capacity		LISTA unit	Art. No.
1 × 60l	411 mm	<b>18 × 36 E</b>	<b>69.937.XXX</b>
2 × 60l	564 mm	<b>27 × 36 E</b>	<b>69.938.XXX</b>
4 × 60l	1023 mm	<b>54 × 36 E</b>	<b>69.939.XXX</b>



**C5 Media supply cabinet**  
1 galvanised\*\* drip tray  
Levelling foot set for cover plates (4 × feet)

Hose port	Cut-outs for modules	400V socket*		LISTA unit	Art. No.
1	–	–	411 mm	<b>18 × 36 E</b>	<b>69.930.XXX</b>
2	–	–	411 mm	<b>18 × 36 E</b>	<b>69.931.XXX</b>
2	–	–	564 mm	<b>27 × 36 E</b>	<b>69.932.XXX</b>
3	–	–	717 mm	<b>36 × 36 E</b>	<b>69.933.XXX</b>
4	–	–	1023 mm	<b>54 × 36 E</b>	<b>69.934.XXX</b>
5	–	–	1193 mm	<b>64 × 36 E</b>	<b>69.935.XXX</b>
2	2	–	411 mm	<b>18 × 36 E</b>	<b>69.990.XXX</b>
2	2	available	411 mm	<b>18 × 36 E</b>	<b>69.991.XXX</b>
2	2	–	564 mm	<b>27 × 36 E</b>	<b>69.992.XXX</b>
2	2	available	564 mm	<b>27 × 36 E</b>	<b>69.993.XXX</b>
2 × 3	–	–	1023 mm	<b>54 × 36 E</b>	<b>69.898.XXX</b>
2 × 4	–	–	1023 mm	<b>54 × 36 E</b>	<b>69.925.XXX</b>

**CC5 Media supply cabinet Compact**  
Hose gates in combination with energy modules  
Order option: additionally incl. 400V socket  
Levelling foot set for cover plates (4 × feet)



**CT5 Media supply tower (height 2000 mm)**  
2 galvanised drip trays\*\*  
Levelling foot set for cover plates (4 × feet)  
Overhead cabinet panels can be used on request for individual control unit

\*The electrical connection must be installed by the customer.

\*\*Galvanisation cannot provide complete protection against all liquids.



**C6 Power module cabinet**  
**Version 1**  
1 × switch/socket outlet 230 V\*\*\*, 2 × 2 socket outlets 230 V,  
2 × 2 network sockets RJ45, Levelling foot set for cover plates (4 × feet)

**Version 2**  
1 × switch/socket outlet 230 V\*\*\*, 2 × 2 socket outlets 230 V,  
2 × compressed-air connections DN7 (inlet: push-on nipple: DN5; outlet: quick-release coupling DN5), Levelling foot set for cover plates (4 × feet)

Type		LISTA unit	Art. No.
CH	411 mm	<b>18 × 36 E</b>	<b>69.910.XXX</b>
D / PE	411 mm	<b>18 × 36 E</b>	<b>69.912.XXX</b>
F	411 mm	<b>18 × 36 E</b>	<b>69.914.XXX</b>
GB	411 mm	<b>18 × 36 E</b>	<b>69.916.XXX</b>
CH	411 mm	<b>18 × 36 E</b>	<b>69.911.XXX</b>
D / PE	411 mm	<b>18 × 36 E</b>	<b>69.913.XXX</b>
F	411 mm	<b>18 × 36 E</b>	<b>69.915.XXX</b>
GB	411 mm	<b>18 × 36 E</b>	<b>69.917.XXX</b>

\*\*\* CH version: 1 × surge protection instead of socket outlet 230 V.

**D** **250 mm**

**W6 Roller shutter cabinet**  
Aluminium roller shutter, self-locking spring-loaded winding.  
High usable depth: 215 mm, punch-outs for power supply.  
Incl. integrated perforated rear panel with 10 × 10 square perforation and 38 mm partitioning. Standard locking, KEY Lock.  
Optionally with integrated cable conduit and adjustable shelves (see page 186)

Housing base			Art. No.
yes	1500 mm	800 mm	<b>69.850.XXX</b>
yes	2000 mm	800 mm	<b>69.851.XXX</b>
no*	1500 mm	1050 mm	<b>69.852.XXX</b>
no*	2000 mm	1050 mm	<b>69.853.XXX</b>

\* For mounting on worktops.



## Toolbox

### Folding countertop

Integrated folding countertop module, single-handed operation. Load capacity: 25 kg. Multiplex top: 564 × 500 × 20 mm. Designed for drawer cabinet depth 27 E and drawer cabinet height 850 mm. See page 73.

### Perforated rear panel for Toolbox 64 E

Self-supporting perforated rear panel module, direct mounting on the drawer cabinet. Square perforation, 10 × 10 mm, 38 mm divisions with slots for holding accessories, usable height 360 mm. Colour as per colour chart. W × H: 1193 × 550 mm See page 73.

### Countertop

This multiplex worktop has been specially adapted to the 64 × 27 E drawer cabinet to ensure a flush transition to the folding countertop Multiplex top: 30 mm (W × D: 1193 × 572 mm).



### Cabinet toolbox 6427E/3 and 6436E/3

The toolbox system for dimensions 64 × 36 E and 64 × 27 E (H: 850 mm) offers the flexible option of accommodating combined drawers in the dimensions 64, 36 and 18 E. See page 73. There are also various accessories that allow the cabinet to be individually configured as a small mobile workstation.

### Perforated side panel

Integrated perforated side rear panel module with 10 × 10 mm square perforation, 38 mm divisions with slots for holding accessories. Designed for drawer cabinet depth 27 E and drawer cabinet height 850 mm H × D: 755 × 570 mm. Sheet steel design. Colour as per colour chart.



### 1. Cabinet housing with locking systems

To have simultaneous locking of all drawers, each cabinet housing can be configured individually using the KEY Lock system.



Housing with KEY Lock

### 2. Drawers

Drawers with different front heights can be incorporated into the same cabinet housing in any order. The insides of the drawer walls are all fitted with a slotted grid in units (E) of 17 mm, which means each drawer can be partitioned as required.



#### Drawer safety catches

**Safety catch on right:** the minimum requirement for mobile drawer cabinets. One-sided drawer safety catch on the right can be released with one hand and prevents accidental opening of drawers even if the cabinet is unlocked.

**i** When ordering a **single safety catch on the right**, please add the suffix **"R"** to the article number in the table (e.g. **72.034.XXX.R**).

#### Ordering tips

When selecting drawers, the clear height of the cabinet housing defines the maximum size. The sum of the drawer front heights (C1 + C2) must correspond to the clear height (B1: 200 mm + B2: 500 mm), see diagram.

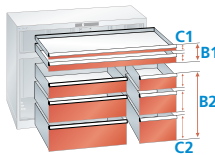

For further drawers, see p. 60/61

#### LISTA Units



Cabinet floor area

W → × D ↗ mm

H ↑ mm Clear height mm  
850 700  
(B1 200 + B2 500)

Depth 27 E

64 × 27 E



1193 × 572

Art. no.   
69.550.XXX

Depth 36 E

64 × 36 E

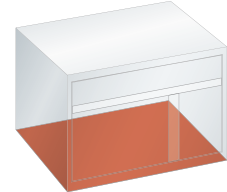

1193 × 725

Art. no.   
69.551.XXX

#### LISTA Units



75 kg

Load capacity

Drawer usable surface

W → × D ↗ mm

H ↑ mm Usable height Shell height  
50\* 32,5 28,5

75 57,5 49

100 82,5 76

125 107,5 76

150 132,5 126

200 182,5 176

250 232,5 226

300 282,5 276

18 × 27 E

36 × 27 E

64 × 27 E

18 × 36 E

36 × 36 E

64 × 36 E

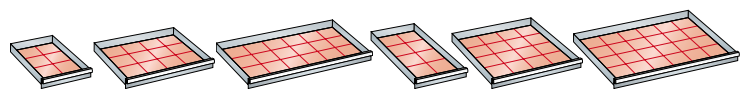

306 × 459

612 × 459

1088 × 459

306 × 612

612 × 612

1088 × 612

Art. no. 72.000.XXX

Art. no. 72.042.XXX

Art. no. -

Art. no. 72.006.XXX

Art. no. 72.057.XXX

Art. no. 72.805.XXX

72.001.XXX

72.043.XXX

-

72.007.XXX

72.058.XXX

72.515.XXX

72.002.XXX

72.045.XXX

72.800.XXX

72.008.XXX

72.060.XXX

72.097.XXX\*\*

-

72.047.XXX

-

-

72.062.XXX

72.098.XXX\*\*

72.003.XXX

72.049.XXX

-

72.009.XXX

72.064.XXX

72.099.XXX\*\*

72.004.XXX

72.051.XXX

72.801.XXX

72.010.XXX

72.066.XXX

72.100.XXX\*\*

-

72.053.XXX

-

-

72.068.XXX

-

72.005.XXX

72.055.XXX

-

72.011.XXX

72.070.XXX

-

\* Drawers with front height of 50 mm must be placed in the top position.

\*\* Load capacity 200 kg: For alternative drawer design, see page 60/61

### 3. Accessories for Toolbox 64 × 27 E

Accessories for the individual configuration of the 64 × 27 E toolbox

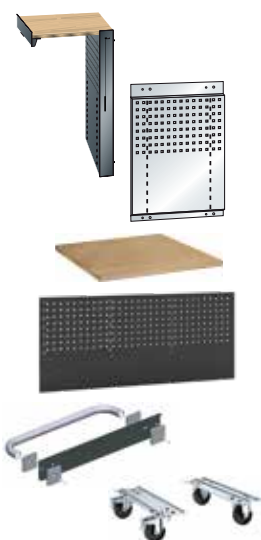

Model

#### Folding countertop

Multiplex top: 20 mm. Plate size (W × H): 500 × 565 mm.  
Max. load capacity: 25 kg. Single-handed operation, Square perforation 10 × 10, suitable for cabinet height 850 mm

Dimensions (mm)

Folded  
86 × 571 × 880 mm  
(W × D × H)

Art. no.

69.555.XXX

#### Perforated side panel

Square perforation 10 × 10, 38 mm divisions with slots.  
Design for cabinet housing height 850 mm

755 × 570 mm  
(H × D)

69.552.XXX

#### Countertop / cover plate

Multiplex 30 mm

1193 × 572 mm  
(W × D)

69.560.000

#### Perforated rear panel

Square perforation 10 × 10, 38 mm divisions with slots.  
Usable height: 360 mm

1193 × 550 mm  
(W × H)

69.553.XXX

#### Push bar

Inc. fastening material for side casing assembly. Galvanised steel.  
Pipe Ø: 22 mm.

Width: 399 mm

12.610.000

#### Pair of castor supports

with rubber castors, 2 swivel castors with brakes and 2 fixed castors. Load capacity: 600 kg.  
Direction of travel: Transverse.

Ø 160 mm  
Height: 204 mm

74.079.000

### 4. Partition material

for drawers

see p. 248



## Drawer cabinets I with hinged or sliding doors

**LISTA drawer cabinets with hinged or sliding doors are ideal for large and heavy inventory items.** The doors enable tall items to be safely locked away and protected from dirt, damage and unauthorised access. The flexible inner partitioning options and a variety of locking systems ensure that you have the best solution for your needs – all with lots of clever details and a 10-year guarantee. Just as you would expect from LISTA.

**+** **Additional storage space and work surfaces**  
through non-slip, easy-to-clean covers with raised edges all round

**>>** **Benefits of LISTA drawer cabinets**  
see p. 38/39

**>>** **Drawer cabinets with hinged or sliding doors for NC storage**  
see p. 76/77 and 100



**+ Ideal for large and heavy inventory items up to 200 kg / drawer**

with pull-out shelves for flush storage

**+ Securely lockable**

with a choice of hinged doors or space-saving sliding doors

**+ Can be adapted to new storage items at any time**

because drawers, pull-out shelves and adjustable shelves can be flexibly added or modified in 25 mm increments

**+ Can easily be moved with a forklift truck**

even with loaded cabinets, by using forklift truck bases

# Drawer cabinets | with hinged or sliding doors



Art. no. **79.432.512**  
Housing: Light grey, RAL 7035  
Fronts: Ruby red, RAL 3003





**36 × 27 E**

**W** → 717 mm

**D** ↗ 600 mm

 612 × 459 mm



H mm	Drawers mm	Pull-out shelves			Art. no. 
1020	1 × 75	2	75	KEY Lock	<b>79.400.XXX</b>
1020	1 × 75	2	200	KEY Lock	<b>79.402.XXX</b>
1020	2 × 75	1	75	KEY Lock	<b>79.404.XXX</b>
1020	2 × 75	1	200	KEY Lock	<b>79.406.XXX</b>
1020	3 × 75	1	75	KEY Lock	<b>79.408.XXX</b>
1020	3 × 75	1	200	KEY Lock	<b>79.410.XXX</b>
1020	3 × 75	2	75	KEY Lock	<b>79.412.XXX</b>
1020	3 × 75	2	200	KEY Lock	<b>79.414.XXX</b>
1020	4 × 75	-	75	KEY Lock	<b>79.416.XXX</b>
1020	4 × 75	-	200	KEY Lock	<b>79.418.XXX</b>
1020	5 × 75	-	75	KEY Lock	<b>79.420.XXX</b>
1020	5 × 75	-	200	KEY Lock	<b>79.422.XXX</b>

## Equipment

All drawer cabinets with a height of 1020 mm on these two pages are equipped with: 3 raised sides, 20 mm high, including ribbed mat.



Art. no. **79.412.512**  
Housing: Light grey, RAL 7035  
Fronts: Ruby red, RAL 3003  
(excluding partition material)



**2 × 36 × 27 E**

**W** → 1430 mm

**D** ↗ 627 mm

 612 × 459 mm



H mm	Drawers mm	Pull-out shelves			Art. no. 
1020	2 × 75	6	75	KEY Lock	<b>79.424.XXX</b>
1020	2 × 75	6	200	KEY Lock	<b>79.425.XXX</b>
1020	4 × 75	2	75	KEY Lock	<b>79.426.XXX</b>
1020	4 × 75	2	200	KEY Lock	<b>79.427.XXX</b>
1020	6 × 75	2	75	KEY Lock	<b>79.428.XXX</b>
1020	6 × 75	2	200	KEY Lock	<b>79.429.XXX</b>
1020	8 × 75	-	75	KEY Lock	<b>79.430.XXX</b>
1020	8 × 75	-	200	KEY Lock	<b>79.431.XXX</b>
1020	4 × 75	4	75	KEY Lock	<b>79.432.XXX</b>
1020	4 × 75	4	200	KEY Lock	<b>79.433.XXX</b>
1020	10 × 75	-	75	KEY Lock	<b>79.434.XXX</b>
1020	10 × 75	-	200	KEY Lock	<b>79.435.XXX</b>



## 2-way pallet/forklift truck base

Made from sheet steel for screwing to the underside of the housing, black, NCS S 9000-N. **Base cover only** for attaching as a cover on the front or rear.

**Base for hinged door cabinet** **74.061.000**  
Dimensions (W × D × H mm) 717 × 506 × 100

**Cover only, for hinged door cabinet** **74.066.000**

**Base for sliding door cabinet** **12.505.000**  
Dimensions (W × D × H mm) 1430 × 560 × 100

**Cover only, for sliding door cabinet** **74.070.000**



Art. no. **79.460.180**  
Grey white, RAL 9002  
(excluding partition material)



NC tool holders and insert frames see p. 102/103



When ordering a drawer cabinet from these two pages with **CODE Lock**, please add the suffix "**C**" or for **RFID** the suffix "**F**" to the article number from the table (e.g. **79.456.XXX.C**).

Other locking systems see p. 28–31

**36 × 36 E**    **W** → 717 mm    **D** ↗ 753 mm

612 × 612 mm



H ↑ mm	Drawer top mm	Drawers mm	Pull-out shelves	kg	Lock	Art. no.
1020	-	2 × 75	2	75	KEY Lock	78.222.XXX
1020	-	2 × 75	2	200	KEY Lock	79.436.XXX
1020	2 adjustable shelves		2	75	KEY Lock	78.220.XXX
1020	2 adjustable shelves		2	200	KEY Lock	79.454.XXX
1020	-	4 × 75	1	75	KEY Lock	79.446.XXX
1020	-	4 × 75	1	200	KEY Lock	79.448.XXX
1020	1 × 150	2 × 75	2	75	KEY Lock	79.456.XXX
1020	1 × 150	2 × 75	2	200	KEY Lock	79.458.XXX
1020	1 × 50 / 1 × 100	1 × 75 / 2 × 100	1	75	KEY Lock	79.460.XXX
1020	1 × 50 / 1 × 100	1 × 75 / 2 × 100	1	200	KEY Lock	79.462.XXX
1020	2 × 75	3 × 75	1	75	KEY Lock	79.464.XXX
1020	2 × 75	3 × 75	1	200	KEY Lock	79.466.XXX
1450	-	2 × 75 / 1 × 150	2	75	KEY Lock	78.256.XXX
1450	-	2 × 75 / 1 × 150	2	200	KEY Lock	79.468.XXX
1450	3 adjustable shelves		2	75	KEY Lock	78.224.XXX
1450	3 adjustable shelves		2	200	KEY Lock	79.470.XXX
1450	-	2 × 75 / 3 × 150	-	75	KEY Lock	79.472.XXX
1450	-	2 × 75 / 3 × 150	-	200	KEY Lock	79.474.XXX



Art. no. **78.256.010**  
Light blue, RAL 5012



**2-way pallet/forklift truck base**

Description see left-hand page

**Base for hinged door cabinet**    **74.062.000**  
Dimensions (W × D × H mm)    717 × 659 × 100

**Cover only, for hinged door cabinet**    **74.066.000**

**Base for sliding door cabinet**    **12.546.000**  
Dimensions (W × D × H mm)    1430 × 713 × 100

**Cover only, for sliding door cabinet**    **74.070.000**

**2 × 36 × 36 E**    **W** → 1430 mm    **D** ↗ 780 mm

612 × 612 mm



H ↑ mm	Drawers mm	Pull-out shelves	kg	Lock	Art. no.
1020	4 × 75	2	75	KEY Lock	78.259.XXX
1020	4 × 75	2	200	KEY Lock	79.482.XXX
1020	4 adjustable shelves	2	75	KEY Lock	78.258.XXX
1020	4 adjustable shelves	2	200	KEY Lock	79.485.XXX
1020	4 × 75	4	75	KEY Lock	79.478.XXX
1020	4 × 75	4	200	KEY Lock	79.479.XXX

# Top-mounted cabinets for drawer cabinets

**Lots of storage in a small space: LISTA top-mounted cabinets provide additional storage area when space is at a premium.** The stored items are in plain sight and easy to reach because they are positioned at viewing height. LISTA top-mounted cabinets are perfectly coordinated with our drawer cabinets and made from high-quality steel. In short: the perfect add-on for fast access to tools and equipment supporting continuous improvement processes such as Kaizen and 5S.

**+ Extra storage area**  
when space is at a premium

**+ Everything in sight**  
through viewing windows made from UV-resistant shatterproof acrylic glass

**+ Extremely user-friendly**  
since the items stored are within easy reach

**+ Securely lockable**  
with a choice of hinged doors or space-saving sliding doors

**+ Can be adapted to new storage items at any time**  
because adjustable shelves can be flexibly added or converted in 25 mm increments

**>> Benefits of LISTA drawer cabinets**  
see p. 38/39



LISTA Units	Depth 27 E			Depth 36 E		
	36 × 27 E	54 × 27 E	78 × 27 E	36 × 36 E	54 × 36 E	78 × 36 E
Cabinet floor area mm	717 × 572 mm	1023 × 572 mm	1431 × 572 mm	717 × 725 mm	1023 × 725 mm	1431 × 725 mm
W → × D ↗						
H ↑ Clear height mm						
Adjustable shelves						
Art. no.						
<b>with solid sheet hinged doors</b>						
1000	930	1	62.637.XXX	62.640.XXX	-	62.636.XXX
<b>with hinged doors with viewing windows</b>						
1000	930	1	-	62.642.XXX	-	62.641.XXX
<b>with solid sheet sliding doors</b>						
1000	930	1	-	62.644.XXX	62.646.XXX	-
<b>with sliding doors with viewing windows</b>						
1000	930	1	-	62.648.XXX	62.650.XXX	-



### Multiplex cover panels

To match combination with drawer cabinet depth 36 E (as bottom cabinet) with top-mounted cabinet depth 27 E. Including pre-drilled holes and fastening material.



### Adjustable shelves, plain

Adjustable shelves including 4 shelf supports. Specification: steel sheet, galvanised. Long sides folded by 4 × 90°. 30 mm thick, load capacity 60 kg. Adjustable in increments of 25 mm.

Suitable for	36 × 27 E	54 × 27 E	78 × 27 E	36 × 36 E	54 × 36 E	78 × 36 E
Art. no.						
<b>Cover panel, H 20 mm</b>	62.695.000	62.696.000	62.697.000	-	-	-
Usable dimensions (W × D mm)	717 × 152	1023 × 152	1431 × 152			
<b>Adjustable shelf, H 30 mm</b>	62.606.000	62.593.000	62.607.000	62.609.000	62.608.000	62.610.000
Usable dimensions (W × D mm)	695 × 497	1001 × 497	1409 × 497	695 × 650	1001 × 650	1409 × 650



### Locking systems

The standard **KEY Lock** locking system with replaceable cylinders allows easy adaptation to existing locking systems. Further locking systems, e.g. CODE Lock and electronic locking via RFID transponder on request.



### Doors with viewing windows

Provide an open view of the contents and also encourage users to keep the contents tidy.



### Pin hinged doors

Doors are flush with the cabinet housing. Opening angle approx. 115°.



### Turn and push cylinder lock and smooth, quiet operation

Cannot be prised out thanks to a bar bent to right angles. The ball bearing rollers of the sliding doors run very quietly on the guide rails.

# MORE FLEXIBLE THAN EVER

The new LISTA workshop trolley L3627 has been optimised for you in all of its key features and now offers you even more benefits, functions and improved ergonomics. In addition to even greater load capacities, its flexibility and adaptability make it the perfect solution for every area in the workplace. Because the basic models can be expanded to meet requirements at any time with versatile superstructures and add-ons.



- + Optimum load capacities**  
Load capacity 40 kg per drawer, 400 kg housing
- + Can be utilised to the full**  
since drawers can be fully extended and drawer shell heights are optimised
- + Absolutely safe to work with**  
Central locking and single drawer opening protection against accidental opening when in motion
- + Flexibly adaptable**  
through perforated side and rear panels for holding accessories and tool hooks
- + Extremely user-friendly**  
with robust, ergonomic push handle
- + Full mobility**  
thanks to the smooth-running fixed and swivel castors (two of each) in solid rubber
- + Additional storage space and work surface**  
through hard-wearing wooden cover or non-slip plastic cover with compartments for small parts
- + Additional safety**  
through rounded corner pieces made from ABS plastic which act as buffers
- >> Fully compatible with LISTA partition material thanks to the standardised unit of measure**  
see p. 248



## + Fully modular and available in a wide range of versions

Depending on use and individual requirements, the basic models can be flexibly expanded in many ways by means of optional accessories.



### Fully extendable without crossbar

- load capacity 40 kg
- enables it to be fully extended
- extremely smooth-running with great ease of movement



### Partition material

- perforated, slotted drawers hold items firmly in place
- extensive range of partition material in the LISTA measurement unit see p. 248



### Labelling

- handle folds upwards
- easy, clean and protected labelling



### Single safety catch

- can be operated with one hand
- protects against accidental opening when in motion



### Central locking

- a central locking system for all drawers
- secure and easy to use



### Smooth-running castors

- two fixed castors
- two swivel castors including brake
- in solid rubber
- with generous  $\varnothing$  100 mm



### Push bar

- robust
- ergonomic
- material: anodised aluminium



### Corner pieces

- protect against damage and also protect other workshop equipment or vehicles in the event of accidental contact
- material: ABS plastic
- colour: black, RAL 9005.



### Wooden cover

- hard-wearing
- sanded, oiled and waxed surface
- material: Multiplex

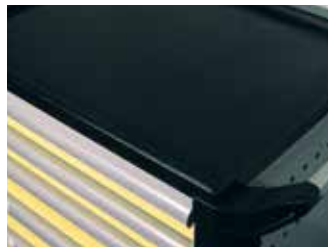

### Plastic cover

- non-slip
- including compartments for small parts
- material: ABS plastic
- colour: black, RAL 9005.



### Perforated side panel

- perforated and slotted for holding accessories and keyhole hooks
- so that everyday tools are always ready to hand



### Perforated rear panel

- for fixing to the rear of workshop trolleys
- perforated and slotted for holding accessories and keyhole hooks see p. 162
- ergonomic tool arrangement

# Workshop trolley L3627



**W** → 894 mm    **D** ↗ 525 mm    **H** ↑ 928 mm    Equipment to suit size **36 × 27 E**

 612 × 459 mm



Equipment

With wooden cover in Multiplex, 40 mm thick, including single safety catch on right

Number of drawers mm

Net weight kg

Art. no. 

4: 1 × 100 / 3 × 200

74

81.060.XXX

5: 2 × 75 / 1 × 150 / 2 × 200

78

81.061.XXX

6: 2 × 75 / 2 × 100 / 1 × 150 / 1 × 200

83

81.062.XXX

7: 4 × 75 / 2 × 100 / 1 × 200

88

81.063.XXX



With plastic cover including single safety catch on right

4: 1 × 100 / 3 × 200

64

81.064.XXX

5: 2 × 75 / 1 × 150 / 2 × 200

68

81.065.XXX

6: 2 × 75 / 2 × 100 / 1 × 150 / 1 × 200

73

81.066.XXX

7: 4 × 75 / 2 × 100 / 1 × 200

78

81.067.XXX



With plastic cover and edge protection including single safety catch on right

4: 1 × 100 / 3 × 200

66

81.068.XXX

5: 2 × 75 / 1 × 150 / 2 × 200

70

81.069.XXX

6: 2 × 75 / 2 × 100 / 1 × 150 / 1 × 200

75

81.070.XXX

7: 4 × 75 / 2 × 100 / 1 × 200

80

81.071.XXX

**!** Note: Additional equipment e.g. castors, drawer partitions or power outlets on request

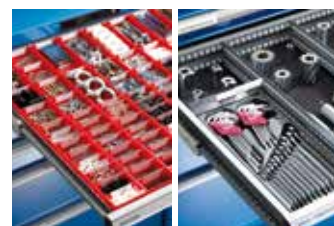

» drawer partition material see p. 248



## Accessories for perforated side panel

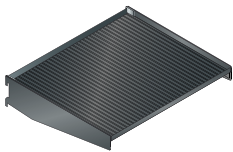

### Add-on tray

Usable width mm	Usable depth mm	Art. no.
380	310	<b>81.081.000</b>

steel sheet, black, powder coated, including ribbed mat, black



### Paper roll holder

for rolls Ø mm	Length mm	Art. no.
400	360	<b>81.058.000</b>

steel sheet, black, powder coated

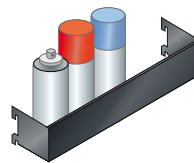

### Spray can holder

Height mm	Width mm	Depth mm	Art. no.
70	380	74	<b>81.083.000</b>

steel sheet, black, powder coated

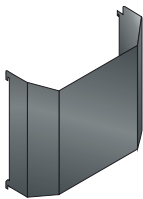

### Waste container

Content litres	Art. no.
12	<b>81.085.000</b>

steel sheet, black, powder coated

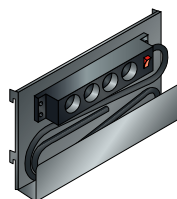

### Socket holding plate for Germany

Length in metres	Art. no.
1,5	<b>81.086.000</b>

NCS S 9000-N, black. With Smart socket strip 4 × German socket, black.

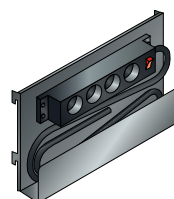

### Socket holding plate for Switzerland

Length in metres	Art. no.
3,0	<b>81.087.000</b>

NCS S 9000-N, black. With Prime-Line socket strip 4 × Swiss socket, black.

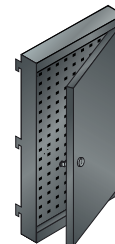

### Perforated panel with door on right

Height mm	Width mm	Depth mm	Art. no.
667	380	50	<b>81.084.000</b>

steel sheet, black, powder coated, lockable

## Perforated rear panel and accessories

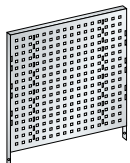

### Perforated rear panel

Height mm	Width mm	Art. no.
640	660	<b>81.080.XXX</b>

steel sheet, square holes 10 × 10 mm, distance between holes 38 mm

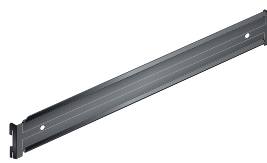

### Container strip

Width mm	Art. no.
665	<b>65.234.060</b>

steel sheet, black, with fixing bracket, load capacity 15 kg, for holding storage containers sizes: 2, 3 and 4 colour: Black



» For keyhole hooks and storage containers see p. 162



# STRONG AND SAFE

**LISTA drawer storage walls are perfect for storing large, heavy single items or a large number of small items and keeping them clearly organised and protected from dust and dirt.** All add-ons, drawers, pull-out shelves and adjustable shelves can be freely combined with one another. This enables a wide variety of different types of installation – even inside trucks and containers. The necessary changes can be made simply by reorganising the individual elements. This means that you can adapt your system to new logistics requirements at any time, so that you always have: A Solution to Match Your Needs. With all the benefits of our drawer cabinets.





- + Utmost stability**  
through robust, sturdy design with a load capacity of up to 5.5 t per shelving unit
- + Large storage capacity with minimum space requirement**  
since shelves can be up to 8.50 m high
- + A wide variety of equipment options**  
with different pull-outs and shelves
- + Vertical pull-outs for clearer organisation and improved safety at work**  
as a space-saving and user-friendly solution with direct access to the stored goods from both sides
- + Heavy-duty pull-outs**  
with load capacities of up to 350 kg for especially large and heavy items
- + User-friendly**  
through swing-out and sliding safety ladders for easy access to the upper shelves and drawers
- + Secure locking**  
with a choice of roller shutters, hinged doors or space-saving sliding doors, optionally with viewing windows
- + Can be adapted to new storage items at any time**  
through the flexible integration and rearrangement of drawers, pull-out shelves and adjustable shelves in increments of 25 mm
- >> Benefits of LISTA drawer cabinets**  
see p. 38/39
- >> Fully compatible with LISTA partition material thanks to the standardised unit of measure**  
see p. 248

# Drawer storage walls



## Separate components

- 1 Side frames
- 2 Rear wall and diagonal brace
- 3 Partition
- 4 Shelf side panel
- 5 Side panel cover
- 6 Universal shelves
- 7 Adjustable shelves
- 8 Dividers
- 9 Drawers
- 10 Fixed and locking shelves
- 11 Pull-out shelves
- 12 Heavy-duty pull-outs
- 13 Side frames for vertical pull-outs\*
- 14 Vertical pull-outs\*
- 15 Shelves for vertical pull-out\*
- 16 Locks for vertical pull-outs\*
- 17 Accessories for vertical pull-outs\*
- 18 Roller shutters, hinged and sliding doors
- 19 Levelling plates
- 20 Anchoring set
- Safety ladder\*
- Accessories for mobile furnishings\*

\* For more information, please contact us.

## + A wide variety of equipment options



9

### Fully extendable drawers

- load capacity 75 kg or 200 kg
- differential pull-outs without crossbar for perfectly smooth running
- for details see p. 40



11

### Fully extendable pull-out shelves

- load capacity 75 kg or 200 kg
- differential pull-outs without crossbar for perfectly smooth running
- inserts provide flush storage
- pull-out shelves with eyelets for fixing heavy parts on request



14

### Vertical pull-outs

- up to a load capacity of 200 kg (500 kg on request)
- for suspended and protective storage of pre-set tools
- optionally available with storage shelves, adjustable shelves, NC holder attachments and perforated panels



12

### Heavy-duty pull-outs

- up to a load capacity of 350 kg
- extremely smooth running
- wood or steel inserts and ribbed mats are available



7 8

### Adjustable and universal shelves, partitions and shelf side panels

- adjustable shelves: load capacity up to 200 kg, can be attached without screws
- universal shelves: up to a load capacity of 250 kg, can be fixed with screws
- optionally either plain or slotted for subdividing with partitions and side panels



6 10



1

### Stable side frames

- for shelf heights up to 8.50 m over several storeys
- can be covered with side panel covers
- also available for special inserts and mobile equipment on request



18

### Secure locking

- with lockable hinged doors
- sliding doors and roller shutters on request

## + Individual configuration options

LISTA drawer storage walls are available in two depths and can be configured to suit your exact individual requirements. The LISTA Unit enables all individual parts, drawers and partition materials to be freely combined with one another and quickly and easily replaced or added to.

### Typical configurations



**D** **27 E**

#### Installed depth 553 mm

- ideal for locations with limited available space
- preferred system for use inside containers
- reduced depth makes it easy to remove heavy parts



**D** **36 E**

#### Installed depth 706 mm

- maximum flexibility through large selection of products and accessories
- allows vertical pull-outs and heavy-duty pull-outs to be used
- available in five different widths

Dimensions and load capacities see next page

## + Flexible range of applications



#### Mobile equipment

- in containers and trucks



#### Medicine storage

- well-organised and within reach

## + User-friendly



#### Safety ladders

- can be swung out and moved sideways for easy access to the upper shelves and drawers

# Drawer storage walls

## Dimensions and load capacities

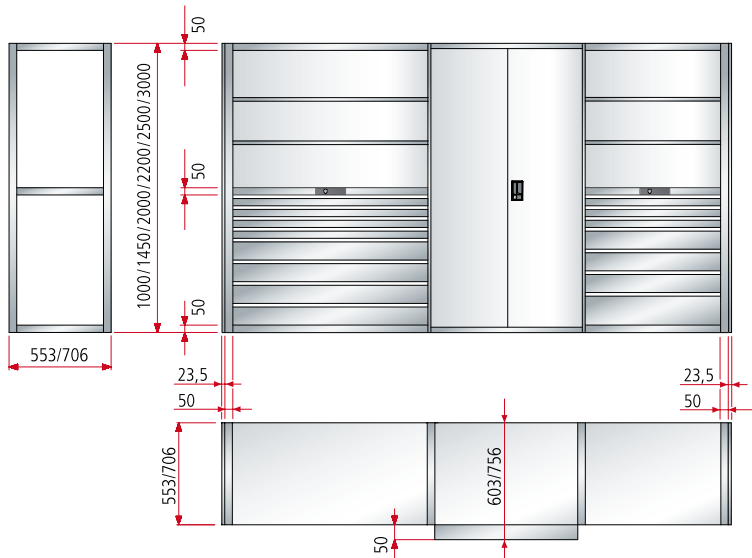

**G** = Unit length (without side panels) = sum of installed widths + sum of side frames  
 Unit length (with side panels) = sum of installed widths + sum of side frames + 47 mm

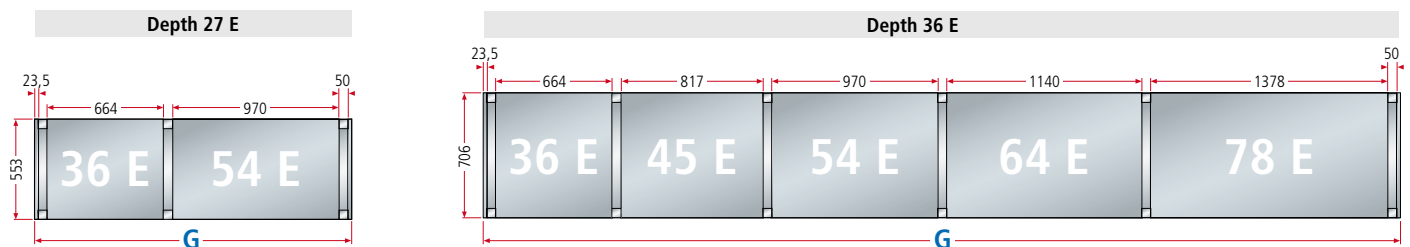

### Unit widths for depth 27 E and 36 E

W → LISTA Units	36 E	45 E	54 E	64 E	78 E
Installed widths mm	664	817	970	1140	1378
Side frames	50	50	50	50	50
Side panel cover	23,5	23,5	23,5	23,5	23,5

## Configure and order drawer storage walls individually



- |  |   |  |
|--|---|--|
| <p><b>LISTA Units</b></p> <ul style="list-style-type: none"> <li>Select floor area of storage wall <math>W \times D</math> (e.g.: <math>664 \times 706</math> mm = <math>36 \times 36</math> E)</li> <li>LISTA Unit <math>E \times E</math> = measurement unit for selecting side frames, stabilising elements, shelves, drawers and hinged doors</li> </ul> | <p><b>1. Side frames and stabilising elements</b></p> <ul style="list-style-type: none"> <li>Select height of side frames H</li> <li>Select stabilising elements: rear panel or diagonal brace</li> <li>Floor anchor, drawer storage walls must be anchored</li> <li>Optional: levelling plates, frame pillar top covering, intermediate fill-in strip, side panel covers and partitions</li> </ul> | <p><b>2. Universal, locking and fixed shelves</b></p> <ul style="list-style-type: none"> <li>Depending on the height of the unit, a minimum number of universal shelves are necessary – please refer to the table</li> <li>Fixed and locking shelves including locking systems are used when drawers need to be lockable. Here, the universal shelves can be dispensed with entirely or used as a top shelf for the top of the side frames.</li> </ul> |
|--|---|--|





**Diagonal brace arrangement**

The load capacities only apply for six shelf units or more two shelf units or at least every fifth shelf unit has rear panels or every third shelf unit has a diagonal brace. From a unit height of 2200 mm an additional universal shelf is required as an intermediate shelf. In the case of two-storey systems, the lower story in every third unit must be fitted with a diagonal brace or rear panel.

**Anchoring rule**

All drawer storage walls must be anchored. 1 anchor is included for each side frame. Exception: double-sided drawer storage walls which are screwed together back-to-back do not need to be anchored.

**Note:** when using only one mounting fixture per side frame, it must be attached to the rear.

**D** = Clear height = number of gaps between slots × 25 mm; slots every 25 mm in the side panels for installing shelves and drawers

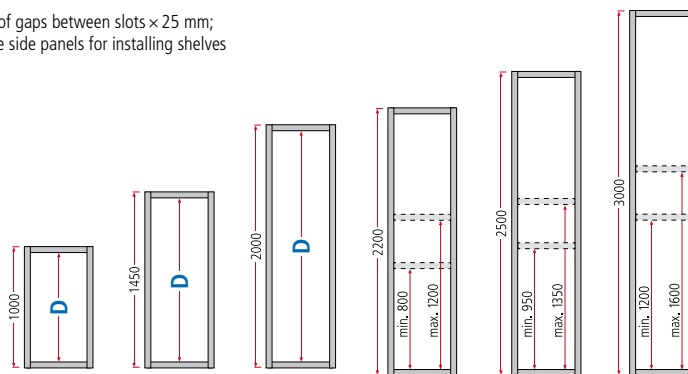

**Wall heights and load capacities**

H ↑ mm	1000	1450	2000	2200	2500	3000
Clear height D mm	900	1350	1900	2050	2350	2850
<b>Load capacity per shelving section</b>						
min. number of universal shelves	2	2	2	3	3	3
min./max. installed height for the middle universal shelves from floor (mm)	-	-	-	900–1300	1050–1450	1300–1700
load capacity per shelving section	5500 kg	5000 kg	4500 kg	5500 kg	5250 kg	5000 kg



**3. Fitments**

- Selection of adjustable shelves, drawers, pull-out shelves and heavy-duty pull-out shelves as desired
- Optional: dividers for adjustable shelves, slotted
- Optional: partition material see p. 248

**4. Front-mounting fitments**

- Lockable hinged doors over partial and total height
- Sliding doors, roller shutters on request

**!** In order to comply with regulations and for reasons of safety, drawer storage walls must consist of at least the following elements:

- Side frames
- Floor anchoring
- Rear panels OR diagonal braces
- Universal shelves (plain or slotted)

» Individual elements see p. 92–99

# Drawer storage walls | heavy-duty versions

For storing heavy single parts and appliances, LISTA drawer storage walls have drawers and pull-out shelves with a load capacity of up to 200 kg. This gives you maximum flexibility – especially when storing NC tools.

**+** Ideal for large and heavy inventory items up to 200 kg per drawer with pull-out shelves for flush storage

**+** Extremely smooth running through differential pull-outs without crossbar

**+** Can be adapted to new storage items at any time through the flexible integration and rearrangement of drawers, pull-out shelves and adjustable shelves in increments of 25 mm

**>>** Benefits of LISTA drawer cabinets see p. 38/39

**>>** Drawer storage walls for NC storage For more information please contact us

**Standard colour combination:**



Housing/shelves:  
light grey, RAL 7035  
Fronts:  
light blue, RAL 5012

**Additional colours available on request.**



Art. no. **70.653.000**  
Housing and shelves:  
light grey, RAL 7035  
Fronts: light blue, RAL 5012



Art. no. **70.657.000**  
Housing and shelves:  
light grey, RAL 7035  
Fronts: light blue, RAL 5012

**54 x 36 E**    **W** → 1117 mm    **D** ↗ 706 mm    **H** ↑ 2200 mm

918 x 612 mm



Specification	🔒	Basic unit Art. no.	Add-on unit Art. no.
3 universal shelves, 2 adjustable shelves, 2 pull-out shelves (200 kg), 1 rear panel, 2 side panels (only for basic unit)	–	<b>70.653.000</b>	<b>70.654.000</b>



3 universal shelves, 2 adjustable shelves, 4 drawers (150 / 200 / 250 / 300 mm) 1 rear panel, 2 side panels (only for basic unit)	KEY Lock	<b>70.655.000</b>	<b>70.656.000</b>
---	----------	-------------------	-------------------



3 universal shelves, 2 adjustable shelves, 7 drawers (50* / 75 / 100 / 125 / 150 / 2 x 200 mm) 1 rear panel, 2 side panels (only for basic unit)	KEY Lock	<b>70.657.000</b>	<b>70.658.000</b>
---	----------	-------------------	-------------------



3 universal shelves, 2 adjustable shelves, 2 pull-out shelves (75 kg), 1 hinged door (H 1000 mm) 1 rear panel, 2 side panels (only for basic unit)	KEY Lock	<b>70.651.000</b>	<b>70.652.000</b>
--	----------	-------------------	-------------------

**i** Drawer load capacity  
up to 200 kg



**Universal and adjustable shelves**

The universal shelves (load capacity 250 kg) are screwed to the side frames. The adjustable shelves (load capacity 200 kg) are attached to the side frames by means of shelf supports and can be adjusted for height. Usable dimensions: W 970 x D 701 mm.



**Pull-out shelves**

For the storage of heavy items and assemblies which can be stored flush with the handle by using a sheet metal insert. Fully extendable. Load capacity 75 or 200 kg. Height-adjustable in 25 mm increments.

» For more universal, adjustable and pull-out shelves see p. 94 and 98

» For suitable partition material for drawers see p. 248

# Drawer storage walls | side frames, stabilising elements

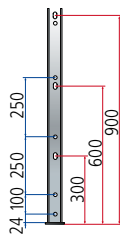
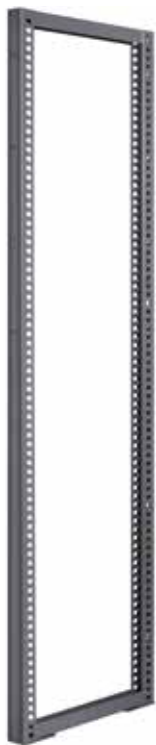

Fastening



## ! Side frames

Side frame with perforations 25 mm apart on both sides, for mounting of runners or shelf supports. Front and rear pillars are welded into a solid frame with horizontal struts. The side frames can optionally be equipped with screw-on locking profiles. With perforations on the back, for screwing to the container wall using horizontal C-brackets. Including 1 floor anchor. Model: frame pillars including horizontal braces made of steel extrusions. Colour: as per colour chart.

## Locking profile

Screw-on locking profile for use of drawers and pull-out shelves with single and double safety catches. Colour: as per colour chart.

## Frame top covering

For covering the top of the side frames. Specification: steel sheet. Colours: as per colour chart.

## Intermediate fill-in strip

To close off intermediate spaces when shelves are placed next to each other at the same height. Including 2 holding bars. Cannot be inserted between side panels and shelves. Specification: Sheet steel. Colours: according to colour chart.

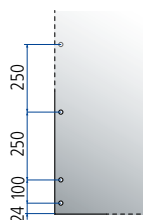
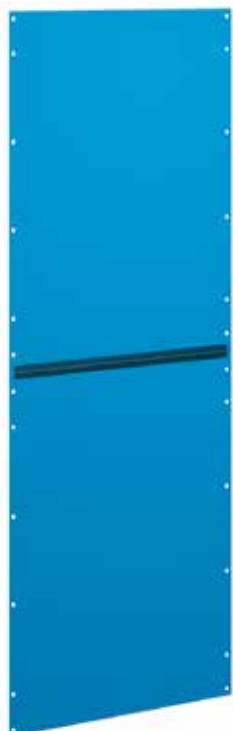

Fastening

## ! Rear panels

Rear cover for row of shelving units. Help to stabilise the shelving units lengthwise. Can be used for base and add-on units. Rear perforations for screwing rear panels to a container wall using horizontal C-brackets. Including screw fasteners. Can be stabilised with diagonal braces instead of rear panels. Specification: steel sheet. Colours: as per colour chart. Joint cross-section: anthracite grey, RAL 7016.

or...

## ! Diagonal braces

Used instead of rear panels to stabilise units lengthwise. Including screw fasteners. Specification: galvanised steel.

**! In order to comply with regulations and for reasons of safety, drawer storage walls must consist of at least the following elements**

For shelf height mm **H** ↑ **1000**

<b>D</b> ↗	Depth mm	Art. no.
<b>27 E</b>	553	<b>79.106.XXX</b>
<b>36 E</b>	706	<b>79.100.XXX</b>

<b>D</b> ↗	Depth mm	Art. no.
<b>27 E</b>	52	<b>79.739.XXX</b>
<b>36 E</b>	52	<b>79.739.XXX</b>

<b>D</b> ↗	Depth mm	Art. no.
<b>27 E</b>	553	<b>79.124.XXX</b>
<b>36 E</b>	706	<b>79.123.XXX</b>

<b>D</b> ↗	Depth mm	Art. no.
<b>27 E</b>	444	<b>79.189.XXX</b>
<b>36 E</b>	597	<b>79.188.XXX</b>

For shelf height mm **H** ↑ **1000**

Installed dimensions mm **W** → × **D** ↗ Art. no.

<b>36 × 27 E</b>	664 × 553	<b>79.125.XXX</b>
<b>54 × 27 E</b>	970 × 553	<b>79.131.XXX</b>
<b>36 × 36 E</b>	664 × 706	<b>79.125.XXX</b>
<b>45 × 36 E</b>	817 × 706	<b>79.500.XXX</b>
<b>54 × 36 E</b>	970 × 706	<b>79.131.XXX</b>
<b>64 × 36 E</b>	1140 × 706	<b>79.137.XXX</b>
<b>78 × 36 E</b>	1378 × 706	<b>79.143.XXX</b>

Number of parts/part dimensions mm 1 × 1000

For shelf height mm **H** ↑ **1000**

Installed dimensions mm **W** → × **D** ↗ Art. no.

<b>36 × 27 E</b>	664 × 553	<b>13.285.000</b>
<b>54 × 27 E</b>	970 × 553	<b>13.394.000</b>
<b>36 × 36 E</b>	664 × 706	<b>13.285.000</b>
<b>45 × 36 E</b>	817 × 706	<b>12.175.000</b>
<b>54 × 36 E</b>	970 × 706	<b>13.394.000</b>
<b>64 × 36 E</b>	1140 × 706	<b>14.355.000</b>
<b>78 × 36 E</b>	1378 × 706	<b>14.356.000</b>

1450	2000	2200	2500	3000
Art. no.	Art. no.	Art. no.	Art. no.	Art. no.
79.107.XXX	79.108.XXX	79.109.XXX	79.110.XXX	79.111.XXX
79.101.XXX	79.102.XXX	79.103.XXX	79.104.XXX	79.105.XXX
Art. no.	Art. no.	Art. no.	Art. no.	Art. no.
79.740.XXX	79.741.XXX	79.742.XXX	79.743.XXX	79.744.XXX
79.740.XXX	79.741.XXX	79.742.XXX	79.743.XXX	79.744.XXX

### Levelling plates

To compensate for height. Enable units to be aligned with precision on uneven floors. Specification: PVC. Colour: grey.



### Levelling plates

Thickness 1 mm	17.140.000
Thickness 2 mm	17.141.000
Thickness 4 mm	17.142.000
Dimensions (W x D mm)	60 x 134



### ! Floor anchoring

Drawer storage walls must be anchored (except for drawer storage walls which are screwed together back-to-back). 1 anchor is included for each side frame.

#### Floor anchor

M 10/130 **112.991.000**

1450	2000	2200	2500	3000
Art. no.	Art. no.	Art. no.	Art. no.	Art. no.
79.126.XXX	79.127.XXX	79.128.XXX	79.129.XXX	79.130.XXX
79.132.XXX	79.133.XXX	79.134.XXX	79.135.XXX	79.136.XXX
79.126.XXX	79.127.XXX	79.128.XXX	79.129.XXX	79.130.XXX
79.501.XXX	79.502.XXX	79.503.XXX	79.504.XXX	79.505.XXX
79.132.XXX	79.133.XXX	79.134.XXX	79.135.XXX	79.136.XXX
79.138.XXX	79.139.XXX	79.140.XXX	79.141.XXX	79.142.XXX
79.144.XXX	79.145.XXX	79.146.XXX	79.147.XXX	79.148.XXX
1 x 1000, 1 x 450	2 x 1000	1 x 1000, 1 x 1200	2 x 1000, 1 x 500	3 x 1000

Rear panels with 10 x 10 mm square holes and 38 mm divisions for holding keyhole hooks available on request.

1450	2000	2200	2500	3000
Art. no.	Art. no.	Art. no.	Art. no.	Art. no.
13.285.000	13.285.000	13.285.000	13.285.000	13.285.000
13.589.000	13.589.000	13.589.000	13.589.000	13.589.000
13.285.000	13.285.000	13.285.000	13.285.000	13.285.000
12.222.000	12.222.000	12.222.000	12.222.000	12.222.000
13.589.000	13.589.000	13.589.000	13.589.000	13.589.000
13.286.000	13.287.000	13.287.000	13.287.000	13.287.000
13.287.000	13.554.000	13.554.000	13.554.000	13.554.000



# Drawer storage walls | panels and shelves



## Side panel covers

Side cover for row of shelving units. For hanging on the side frames by means of shelf supports. Including floor anchor. Specification: steel sheet. Colours: as per colour chart.



## Partitions

For retrofitting by hanging in the side frames. Serves to protect against theft, especially behind sliding doors, hinged doors and roller shutters. Can be used on left and right. Specification: steel sheet. Colours: as per colour chart.

**N.B.** Remember to order a nut holder for fastening the shelf.

## Shelf side panels

Used to cover a side end where an intermediate fill-in strip cannot be used to close an intermediate space. Attached to the side frames. Can also be used with folding fronts. Model: Sheet steel. Colour: Light grey, RAL 7035.

**Delivery: as a pair (left and right version)**

\* Min. clear height mm of compartment equals height + 50 mm.



## Folding fronts

Can only be used with universal shelves. Fold 180 degrees downwards. Equipment: Double safety catch, labelling strip throughout, handle covers and self-adhesive labels. Colours: according to colour chart.



## Universal shelves, plain or slotted

Screwed to the side frames as top and bottom closure and intermediate shelf. Including screw fasteners. Choice of plain or slotted versions. Slots 15 mm apart for subdividing partitions. Specification: steel sheet. Colours: as per colour chart.



## Adjustable shelves, plain or slotted

Are inserted between the side frames using shelf supports, with welded strengthener. Choice of plain or slotted versions. Slots 15 mm apart for subdividing with partitions. Including 4 shelf supports each. Specification: steel sheet. Colours: as per colour chart.



## Partitions

To subdivide the slotted universal and adjustable shelves. Specification: steel sheet. Colour: light grey, RAL 7035.

For shelf height mm	<b>H ↑</b>	<b>1000</b>
<b>D ↗</b>	Depth mm	Art. no.
<b>27 E</b>	553	<b>13.388.XXX</b>
<b>36 E</b>	706	<b>13.252.XXX</b>
Number of parts/crossbars		1
Dimensions (W mm)		23,5

For shelf height mm	<b>H ↑</b>	<b>1000</b>
<b>D ↗</b>	Depth mm	Art. no.
<b>27 E</b>	553	<b>79.176.XXX</b>
<b>36 E</b>	706	<b>79.170.XXX</b>
Number of parts/crossbars		1

Wall height mm	<b>H ↑</b>	<b>150</b>
<b>D ↗</b>	Depth mm	Art. no.
<b>27 E</b>	506	<b>79.014.000</b>
<b>36 E</b>	659	<b>79.011.000</b>

		<b>Depth 27 E</b>
<b>LISTA Units</b>		<b>36 × 27 E</b>
Installed dimensions mm		<b>664 × 553</b>
<b>W →</b> × <b>D ↗</b> mm	min. clear opening (mm)	Art. no.
<b>H ↑</b>	150	125* <b>79.298.XXX</b>
	200	175* <b>79.299.XXX</b>
	250	225* <b>79.300.XXX</b>
	300	275* <b>79.301.XXX</b>
Usable width (mm)		250

<b>Universal shelf, H 50 mm</b>	
plain	<b>79.191.XXX</b>
Load capacity (kg)	250
slotted	<b>79.197.XXX</b>
Load capacity (kg)	250
Usable dimensions (W × D mm)	664 × 552

<b>Adjustable shelf, H 25 mm</b>	
plain	<b>79.203.XXX</b>
Load capacity (kg)	200
slotted	<b>79.209.XXX</b>
Load capacity (kg)	200
Usable dimensions (W × D mm)	664 × 548

Wall height mm	<b>H ↑</b>	<b>95</b>
<b>D ↗</b>	Depth mm	Art. no.
<b>27 E</b>	525	<b>123.716.000</b>
<b>36 E</b>	678	<b>100.434.000</b>

1450	2000	2200	2500	3000
Art. no.	Art. no.	Art. no.	Art. no.	Art. no.
13.389.XXX	13.390.XXX	13.391.XXX	13.392.XXX	13.393.XXX
13.253.XXX	13.254.XXX	13.255.XXX	13.256.XXX	13.257.XXX
1	1	1	2	2
23,5	23,5	23,5	23,5	23,5

Side panel covers with 10 × 10 mm square holes and 38 mm divisions for holding keyhole hooks available on request.

1450	2000	2200	2500	3000
Art. no.	Art. no.	Art. no.	Art. no.	Art. no.
79.177.XXX	79.178.XXX	79.179.XXX	79.180.XXX	79.181.XXX
79.171.XXX	79.172.XXX	79.173.XXX	79.174.XXX	79.175.XXX
1	1	2	2	3

Partitions with 10 × 10 mm square holes and 38 mm divisions for holding keyhole hooks available on request.

200	250
Art. no.	Art. no.
79.015.000	79.016.000
79.012.000	79.013.000



### Nut holder

For fastening shelves into units where there is no access to the side frames. 2 each per shelf next to partition.  
Specification: steel sheet, bright galvanised.

L 55 mm, 1 piece

16.997.000



Depth 36 E					
54 × 27 E	36 × 36 E	45 × 36 E	54 × 36 E	64 × 36 E	78 × 36 E
970 × 553	664 × 706	817 × 706	970 × 706	1140 × 706	1378 × 706
Art. no.	Art. no.	Art. no.	Art. no.	Art. no.	Art. no.
79.302.XXX	79.298.XXX	79.542.XXX	79.302.XXX	79.306.XXX	79.310.XXX
79.303.XXX	79.299.XXX	79.543.XXX	79.303.XXX	79.307.XXX	79.311.XXX
79.304.XXX	79.300.XXX	79.544.XXX	79.304.XXX	79.308.XXX	79.312.XXX
79.305.XXX	79.301.XXX	79.545.XXX	79.305.XXX	79.309.XXX	79.313.XXX
250	250	250	250	250	250
79.193.XXX	79.190.XXX	79.514.XXX	79.192.XXX	79.194.XXX	79.195.XXX
450	250	250	475	400	350
79.199.XXX	79.196.XXX	79.515.XXX	79.198.XXX	79.200.XXX	79.201.XXX
250	250	250	250	400	350
970 × 552	664 × 705	817 × 705	970 × 705	1140 × 705	1378 × 705
79.205.XXX	79.202.XXX	79.516.XXX	79.204.XXX	79.206.XXX	79.207.XXX
200	200	200	200	200	200
79.211.XXX	79.208.XXX	79.517.XXX	79.210.XXX	79.212.XXX	79.213.XXX
200	200	200	200	200	200
970 × 548	664 × 701	817 × 701	970 × 701	1140 × 701	1378 × 701

145	195
Art. no.	Art. no.
123.717.000	123.718.000
100.435.000	100.436.000

**!** In order to comply with regulations and for reasons of safety, drawer storage walls must consist of at least the following elements



# Drawer storage walls | drawers, locking and fixed shelves



Select load capacity

**i** When ordering a **single safety catch on the right**, please add the suffix **"R"** to the article number in the table (e.g. **72.034.XXX.R**).

## Drawers

Drawers with different front heights can be incorporated into the same shelf unit in any order. The insides of the drawer walls are all fitted with a slotted grid in units (E) of 17 mm so that each drawer can be partitioned as required.

## Ordering information

When selecting the drawers, the clear height of the wall defines the maximum size. The sum of the drawer front heights (C) must be equal to the clear height (B) (see diagram). For filling and loading the drawers and drawer walls please follow the installation manual and observe the loading rules. Load capacity applies to an evenly distributed load.

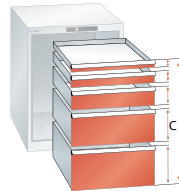

LISTA Units

**75 kg**  
Load capacity

Drawer usable surface mm

**W** × **D**

H mm	Usable height	Shell height	Art. no.
50*	32,5	28,5	72.042.XXX

75	57,5	49	72.043.XXX
100	82,5	76	72.045.XXX
125	107,5	76	72.047.XXX
150	132,5	126	72.049.XXX
200	182,5	176	72.051.XXX
250	232,5	226	72.053.XXX
300	282,5	276	72.055.XXX

**200 kg**  
Load capacity

75	57,5	49	72.044.XXX
100	82,5	76	72.046.XXX
125	107,5	76	72.048.XXX
150	132,5	126	72.050.XXX
200	182,5	176	72.052.XXX
250	232,5	226	72.054.XXX
300	282,5	276	72.056.XXX

Depth 27 E

**36 × 27 E**

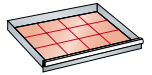

**612 × 459 mm**

Art. no.

72.042.XXX

72.043.XXX

72.045.XXX

72.047.XXX

72.049.XXX

72.051.XXX

72.053.XXX

72.055.XXX

Depth 27 E

**36 × 27 E**

LISTA Units

Installed dimensions mm

**W** × **D**

**Locking shelf**  
prepared for locking system

H 50 mm, load capacity 200 kg

**Fixed shelf**  
prepared for locking system

H 50 mm, load capacity 50 kg

Art. no.

79.243.XXX

79.243.XXX

79.237.XXX

79.237.XXX

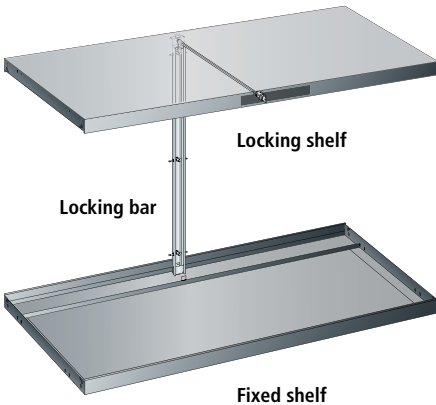

## Locking and fixed shelves

Locking and fixed shelves are screwed to the side frames at any position and are ready to accept the installation of **drawer locking systems**. Including screw fasteners. Specification: steel sheet. Colours: as per colour chart.

## Locks

The central locking system for installation into the locking shelf only locks all drawers beneath it. Choice of configurable KEY Lock or CODE Lock locking systems.

Locking for entire height on request.



## KEY Lock locking system

including cylinder with different keys and with locking bar

H mm Art. no.

1000 900 19.220.000

1150 1050 19.221.000

1325 1225 19.222.000

1450 1350 19.223.000

**i**

When ordering a lock with **CODE**, **RFID** or **AUTO Lock**, please add the suffix **"C"**, **"F"** or **"A"**, respectively, to the article number stated in the table (e.g. **19.220.000.C**).





Depth 36 E					
54 × 27 E	36 × 36 E	45 × 36 E	54 × 36 E	64 × 36 E	78 × 36 E
918 × 459 mm	612 × 612 mm	765 × 612 mm	918 × 612 mm	1088 × 612 mm	1326 × 612 mm
Art. no.	Art. no.	Art. no.	Art. no.	Art. no.	Art. no.
72.080.XXX	72.057.XXX	72.072.XXX	72.088.XXX	72.805.XXX	72.806.XXX
72.505.XXX	72.058.XXX	72.540.XXX	72.510.XXX	72.515.XXX	72.517.XXX
72.506.XXX	72.060.XXX	72.541.XXX	72.511.XXX	72.516.XXX	72.518.XXX
72.507.XXX	72.062.XXX	72.542.XXX	72.512.XXX	-	-
72.508.XXX	72.064.XXX	72.543.XXX	72.513.XXX	-	-
72.509.XXX	72.066.XXX	72.544.XXX	72.514.XXX	-	-
-	72.068.XXX	-	-	-	-
-	72.070.XXX	-	-	-	-

\* Drawers with a front height of 50 mm must be placed in the top position

72.081.XXX	72.059.XXX	72.073.XXX	72.089.XXX	72.096.XXX	72.103.XXX
72.082.XXX	72.061.XXX	72.074.XXX	72.090.XXX	72.097.XXX	72.104.XXX
72.083.XXX	72.063.XXX	72.075.XXX	72.091.XXX	72.098.XXX	72.105.XXX
72.084.XXX	72.065.XXX	72.076.XXX	72.092.XXX	72.099.XXX	72.106.XXX
72.085.XXX	72.067.XXX	72.077.XXX	72.093.XXX	72.100.XXX	72.107.XXX
72.086.XXX	72.069.XXX	72.078.XXX	72.094.XXX	72.101.XXX	72.108.XXX
72.087.XXX	72.071.XXX	72.079.XXX	72.095.XXX	72.102.XXX	72.109.XXX

Depth 36 E					
54 × 27 E	36 × 36 E	45 × 36 E	54 × 36 E	64 × 36 E	78 × 36 E
970 × 553 mm	664 × 706 mm	817 × 706 mm	970 × 706 mm	1140 × 706 mm	1378 × 706 mm
Art. no.	Art. no.	Art. no.	Art. no.	Art. no.	Art. no.
79.245.XXX	79.242.XXX	79.550.XXX	79.244.XXX	79.246.XXX	79.247.XXX
79.239.XXX	79.236.XXX	79.549.XXX	79.238.XXX	79.240.XXX	79.241.XXX

Art. no.	Art. no.	Art. no.	Art. no.	Art. no.	Art. no.
19.220.000	19.200.000	19.200.000	19.200.000	19.200.000	19.200.000
19.221.000	19.201.000	19.201.000	19.201.000	19.201.000	19.201.000
19.222.000	19.202.000	19.202.000	19.202.000	19.202.000	19.202.000
19.223.000	19.203.000	19.203.000	19.203.000	19.203.000	19.203.000



#### KEY Lock

The standard locking system with replaceable cylinders makes it easy to adapt to existing locking systems. The locking system secures all drawers simultaneously.



#### CODE Lock

Here the key is replaced by a simple numeric combination. A simple four to six-digit numeric combination is sufficient to open the drawer.



#### RFID Lock

The LISTA RFID Lock enables automatic and contactless locking through radio frequency identification. After a positive RFID read a rotary handle must be turned by hand to unlock.



#### AUTO Lock

Like LISTA RFID Lock, opens and locks the cabinet automatically without manual operation. Access and locked time management with LISTA Access software via USB.



# Drawer storage walls | drawers, pull-out shelves and doors



## Pull-out shelves

For storing heavy individual items and equipment. Variable fitting heights of 25 × 25 mm in the side panels. The inserts enable stored items to be stored and removed flush with the handle. Specification: steel sheet. Colours: as per colour chart. Bottom inserts are made of galvanised steel.



## Heavy-duty pull-outs

Heavy-duty pull-outs are mainly used in machine tool production for storage of assemblies and tools. Even with a heavy load, the heavy-duty pull-out is easy to use. With a welded construction and pull-out frames running on multiple ball-bearings. The runners can be built directly into the side panels of the drawer walls of sizes 54 × 36 E without any adjustments. Specification: Shaped steel sheet. Colour: Grey, NCS S 4502-R.



## Inserts and supports for heavy-duty pull-out shelves

**Multiplex top:** Can be inserted without screwing into the heavy-duty pull-out shelves. Made of steamed beech veneers, glued in multiple waterproof layers, rounded corners. Sanded, oiled and waxed surface. The top is splash-proof, dirt-repellent and largely proof against oil and grease.

**Slat inserts:** can be inserted without screwing into the heavy-duty pull-out shelves. Specification: Sendzimir galvanised shaped sheet steel.

**Ribbed mats:** provide protection. To be placed on top of the wooden inserts or on the metal slat insert panels. Specification: includes self-adhesive strips. Colour: Black.



## Hinged doors made of full sheet steel or equipped with viewing windows

With two panels and a two-point rod lock with a recess for a clasp lock. The hinged doors can be retrofitted to all shelf units. Specification: sheet steel or sheet steel with viewing windows. Colours: as per colour chart.

**!** For the version with **hinged doors**, the **clasp lock** shown below must be ordered separately.

## Clasp locks

The standard KEY Lock locking system with replaceable cylinders makes it easy to adapt to existing locking systems. With CODE Lock, the key is replaced by a simple numeric combination. The LISTA RFID Lock enables automatic and contactless locking through radio frequency identification. After a positive RFID read the handle is operated by hand.



Depth 27 E

**36 × 27 E**

LISTA Units

Drawer usable surface mm

**W** × **D**

**612 × 459 mm**

## Pull-out shelves

Load capacity kg	min. installation height mm	Art. no.
75	75	79.219.XXX
200	75	79.223.XXX

## Heavy-duty pull-outs, H 155 mm

Load capacity kg	min. installation height mm	Art. no.
350	215	-
Usable dimensions (W × D mm)		

## Multiplex top, H 50 mm

Usable dimensions (W × D mm)

## Slat inserts, H 54,5 mm

Number of slats

Usable dimensions (W × D mm)

## Ribbed mats, H 3 mm

Usable dimensions (W × D mm)

**36 × 27 E**

For shelf height mm For fitting Art. no.

## Hinged doors made of full sheet steel, 2 doors without clasp lock, with different keys

1000	bottom	79.248.XXX
1000	top	79.521.XXX
2000	bottom	79.249.XXX
2200	bottom	79.250.XXX
2500	bottom	79.251.XXX

## Hinged doors with viewing windows, 2 doors without clasp lock, with different keys

1000	bottom	79.630.XXX
1000	top	79.631.XXX
2000	bottom	79.632.XXX
2200	bottom	79.633.XXX
2500	bottom	79.634.XXX

## + clasp lock with different keys

with KEY Lock	49.060.000
with CODE Lock	49.085.000
with RFID Lock	49.086.000

Depth 36 E					
54 × 27 E	36 × 36 E	45 × 36 E	54 × 36 E	64 × 36 E	78 × 36 E
918 × 459 mm	612 × 612 mm	765 × 612 mm	918 × 612 mm	1088 × 612 mm	1326 × 612 mm
Art. no.	Art. no.	Art. no.	Art. no.	Art. no.	Art. no.
79.221.XXX	79.218.XXX	79.519.XXX	79.220.XXX	-	-
79.225.XXX	79.222.XXX	79.520.XXX	79.224.XXX	79.226.XXX	79.227.XXX
-	79.228.000	79.617.000	79.229.000	79.618.000	79.619.000
-	588 × 614	741 × 614	894 × 614	1064 × 614	1302 × 614
-	12.514.000	12.640.000	12.515.000	12.641.000	12.642.000
-	588 × 614	741 × 614	894 × 614	1064 × 614	1302 × 614
-	12.519.000	12.643.000	12.520.000	12.644.000	12.645.000
-	4	4	4	4	4
-	588 × 614	741 × 614	894 × 614	1064 × 614	1302 × 614
-	12.516.000	12.646.000	12.517.000	12.647.000	12.648.000
-	588 × 614	741 × 614	894 × 614	1064 × 614	1302 × 614
54 × 27 E	36 × 36 E	45 × 36 E	54 × 36 E	64 × 36 E	78 × 36 E
Art. no.	Art. no.	Art. no.	Art. no.	Art. no.	Art. no.
79.252.XXX	79.248.XXX	79.522.XXX	79.252.XXX	79.528.XXX	79.533.XXX
79.527.XXX	79.521.XXX	79.523.XXX	79.527.XXX	79.529.XXX	79.534.XXX
79.253.XXX	79.249.XXX	79.524.XXX	79.253.XXX	79.530.XXX	79.535.XXX
79.254.XXX	79.250.XXX	79.525.XXX	79.254.XXX	79.531.XXX	79.536.XXX
79.255.XXX	79.251.XXX	79.526.XXX	79.255.XXX	79.532.XXX	79.537.XXX
79.640.XXX	79.630.XXX	79.635.XXX	79.640.XXX	79.645.XXX	79.650.XXX
79.641.XXX	79.631.XXX	79.636.XXX	79.641.XXX	79.646.XXX	79.651.XXX
79.642.XXX	79.632.XXX	79.637.XXX	79.642.XXX	79.647.XXX	79.652.XXX
79.643.XXX	79.633.XXX	79.638.XXX	79.643.XXX	79.648.XXX	79.653.XXX
79.644.XXX	79.634.XXX	79.639.XXX	79.644.XXX	79.649.XXX	79.654.XXX
49.060.000	49.060.000	49.060.000	49.060.000	49.060.000	49.060.000
49.085.000	49.085.000	49.085.000	49.085.000	49.085.000	49.085.000
49.086.000	49.086.000	49.086.000	49.086.000	49.086.000	49.086.000



# PROFESSIONALS AT WORK

**NC storage and transport systems made by LISTA give you the perfect solution for your tool logistics.** Our NC modules not only provide professional storage in inserts specially optimised for your machining and cutting tools, but also a safe method of transporting them. Tools are stored in a space-saving and organised way and are always within reach and ready for use. That's not all: our NC modules can be individually equipped and can of course be freely combined with the entire LISTA system in order to make the best possible use of the valuable space in your production facility.



**+ Safe, neat and orderly storage**  
in high-quality inserts made from break-proof, impact-proof and oil-resistant ABS material tailored to hold your cutting tools

**+ Optimum use of space**  
because these high-capacity systems are not only space-saving, but the tools are just where you need them – right next to the machine

**+ Customised and easy to assemble**  
using tool holders with snap fasteners for tool-free insertion and removal

**+ Secure transport**  
thanks to robust and stable design

**+ User-friendly and ergonomic**  
because tool holders can be fitted at an angle and shelves and drawers can be pulled out

**>> Benefits of the LISTA drawer cabinets**  
see p. 38/39

## Partitioning schemes for NC tool containers

The capacity of each of the different storage and transport units for NC tools is given in the table below. The partitioning scheme for each type of tool is given next to the corresponding article number. With this scheme you can use the table to calculate the maximum capacity for each storage and transport unit used.

### Insert frames in drawers and NC transport units

Units (E)	Dimensions mm (W×D)	A	B	D	E	F	G	H
36 × 27 E*	612 × 459	27	24	21	18	15	12	3
54 × 27 E	918 × 459	42	39	33	27	24	21	–
36 × 36 E*	612 × 612	36	32	28	24	20	16	4

\* also for NC transport units

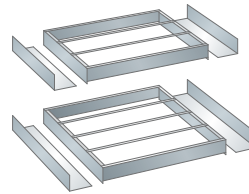

### NC storage in vertical pull-outs

» Drawer storage walls and vertical pull-out cabinets see p. 84 and 190

### Tool cradles for NC cabinets and NC transport units

suitable for Width (E)	Dimensions mm (W×D)	A	B	D	E	F	G	H
36 E*	562 × 140	9	8	7	6	5	4	1
54 E**	946 × 140	16	14	12	10	8	7	–

\* for NC transport trolleys and vertical pull-out cabinets (see p. 190) \*\* for NC cabinets

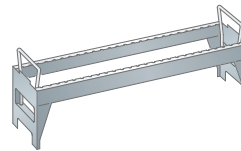

### NC storage in transport units

### NC bench stand

With insert frame for 3 strips.

Units (E)	Dimensions mm (W×D)	A	B	D	E	F	G	H
36 × 27 E	588 × 413 × 345	27	24	21	18	15	12	3

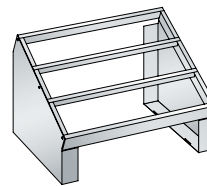

### NC storage in bench stand

## Version with pair of frame supports

LISTA frame supports for NC systems have adjustable ranges with three positions so that the height can be variably adjusted to match the items stored. The distance from the insert frame to the top of the tool holder is always 12 mm.

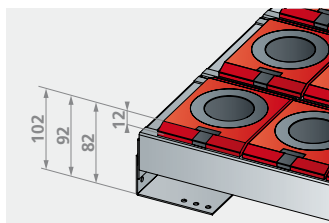

For storage heights  
82 – 102 mm  
(27 E and 36 E)

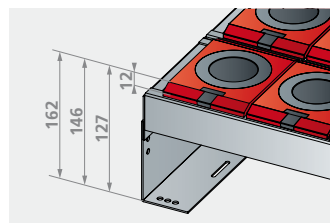

For storage heights  
127 – 162 mm  
(27 E and 36 E)

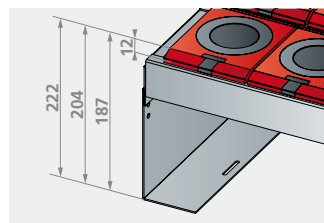

For storage heights  
187 – 222 mm  
(27 E and 36 E)



### NC storage in drawers

» Drawer cabinets with hinged or sliding doors see p. 74

## Version with tool cradles

LISTA tool cradles for NC systems are available in two heights. The distance from the cradle to the top of the tool holder is always 12 mm.

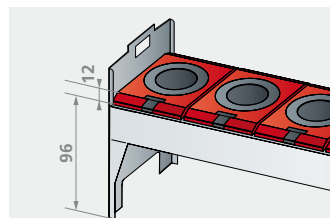

For storage heights 96 – 135 mm  
(27 E and 36 E)

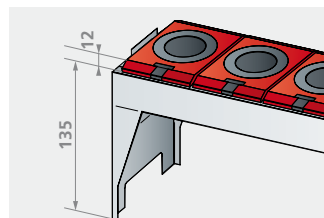

### NC storage in cabinets

## NC tool holder system

With this system a number of versions are available for different tools and can be fitted in a support in any combination. The holders are screwed together or fixed by means of snap fastener. Specification: high-quality plastic. Colour: red.



**Note**  
HSK tool holders are available in green on request. The red and green tool holders are required to differentiate between sharp and used tools.

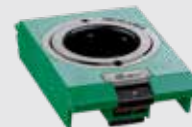

» Partitioning schemes see p. 101



### ISO-SK tool holders

Specification	Width mm	Height mm	Cone Ø top mm	Number of tools per holder	Partitioning schemes	Art. no.
ISO-SK 30	65,6	49	31,8	1	B	12.880.000
ISO-SK 40	65,6	60,5	44,5	1	B	12.062.000
ISO-SK 45	105	75	57,2	1	F	12.877.000
ISO-SK 50	105	90	69,9	1	F	12.875.000



### HSK tool holders

Specification	Width mm	Height mm	Cone Ø top mm	Number of tools per holder	Partitioning schemes	Art. no.
HSK 32 A+C+E/40 B+D+F	58	31	24	1	A	15.314.000
HSK 40 A+C+E/50 B+D+F	58	31	30	1	A	15.318.000
HSK 50 A+C+E/63 B+D+F	65,6	31	38	1	B	15.319.000
HSK 63 A+C+E/80 B+D+F	87,5	34	48	1	E	15.320.000
HSK 80 A+C+E/100 B+D+F	105	42	60	1	F	15.330.000
HSK 100 A+C+E/125 B+D+F	120	52	75	1	G	15.336.000

Tool holders for HSC hollow shaft cylinders are available on request.



### VDI tool holders

Specification	Width mm	Height mm	Cylindrical hole Ø mm	Number of tools per holder	Partitioning schemes	Art. no.
VDI 20 cylindrical*	58	20	20,5	1	A	15.329.000
VDI 25 cylindrical*	58	20	25,4	1	A	12.866.000
VDI 30 cylindrical	65,6	69,5	30,5	1	B	12.887.000
VDI 40 cylindrical	87,5	77,5	40,5	1	E	12.886.000
VDI 50 cylindrical	87,5	93,5	50,0	1	E	12.885.000
VDI 60 cylindrical	105	108,5	60,5	1	F	12.884.000

\*Screwed, see tool holders to drill out yourself.



### Capto tool holders

Specification	Width mm	Height mm	Cone Ø top mm	Number of tools per holder	Partitioning schemes	Art. no.
Capto C3	58	31,5	22	1	A	12.650.000
Capto C4	58	31,5	28	1	A	12.651.000
Capto C5	65,6	31,5	35	1	B	12.652.000
Capto C6	87,5	34	44	1	E	12.653.000
Capto C8	105	42	55	1	F	12.654.000
Capto C10	120	52	72	1	G	12.655.000

### Tool holders to drill out yourself

For any tools.

Specification	Width mm	Depth mm	Height mm	Number of tools per holder	Partitioning schemes	Art. no.
for you to drill out 58*	58	138	20	as you like	A	12.832.000
for you to drill out 535*	535	138	20	as you like	H	12.838.000

\*Screwed.



\* Explanation of "screwed": screwed tool holders are screwed onto the insert frame or the tool cradle frame with 1 or 2 allen screws.

## Insert frame and pairs of frame supports

Available as a set or as individual components. One pair of frame supports is needed for each insert frame. By having frame supports in different heights which can be screwed onto the perforated drawer base together with the insert frame, tools with different cone lengths can be stored in drawers.



Adjustable ranges see p. 101

Partitioning schemes see p. 101

**i** **Ordering information**  
Always take into account the maximum storage height of the tools including any fitting pins.

## Insert frame for drawers

To accommodate all types of tool holder. One pair of frame supports is needed for each insert frame. Including screw fasteners. Without pair of frame supports. Specification: steel sheet. Colour: grey, NCS S 4502-B.

For drawer sizes Unit (E)	Number of rows	Width mm	Depth mm	Height mm	Art. no.
36 × 27 E	3	584	447	64	12.846.000
54 × 27 E	3	890	447	64	12.243.000
36 × 36 E	4	584	596	64	12.848.000



## Pair of frame supports for insert frame

The position of the insert frames can be adjusted for height. Not necessary for tools with a height of less than 64 mm. Including screw fasteners. Specification: steel sheet. Colour: grey, NCS S 4502-B.

For depth (E)	Specification	Height mm	Cone length mm	Art. no.
27 E	447/60–110	60–110	80–160	12.907.000
36 E	596/60–110	60–110	80–160	12.904.000

For insert frames 12.846.000, 12.243.000.

For insert frames 12.848.000.



## Tool holder sets 36 × 27 E

For inserting into drawers. Includes 1 insert frame, 1 pair of frame supports Art. no. 12.907.000. Width 588 mm, depth 447 mm, height 82–162 mm.

Equipped with	Partitioning schemes	Art. no.
24 holders ISO-SK 40	B	80.824.000
15 holders ISO-SK 50	F	80.825.000
24 holders HSK 50 A+C+E/63 B+D+F	B	80.827.000
18 holders HSK 63 A+C+E/80 B+D+F	E	80.828.000



## Tool holder sets 36 × 36 E

For inserting into drawers. Includes 1 insert frame, 1 pair of frame supports Art. no. 12.904.000. Width 588 mm, depth 596 mm, height 82–162 mm.

Equipped with	Partitioning schemes	Art. no.
32 holders ISO-SK 40	B	80.829.000
20 holders ISO-SK 50	F	80.830.000
32 holders HSK 50 A+C+E/63 B+D+F	B	80.832.000
24 holders HSK 63 A+C+E/80 B+D+F	E	80.833.000

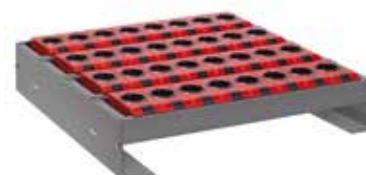



## NC cabinets with roller shutters

**W** → 1038 mm    **D** ↗ 691 mm    **H** ↑ 1950 mm    Specification to suit size **54 × 27 E**

918 × 459 mm

Specification

Holder type

Partitioning schemes

Art. no.



4 Drawers (front height 75 mm, load capacity 200 kg),  
4 Insert frames including pair of frame supports, Art. no. 12.907.000, including single-drawer opening system

without tool holder	–	<b>78.971.XXX</b>
156 holders ISO-SK 40	B	<b>78.972.XXX</b>
96 holders ISO-SK 50	F	<b>78.973.XXX</b>
108 holders HSK 63 A+C+E/80 B+D+F	E	<b>78.975.XXX</b>



8 Tool cradle  
8 Pair of frame supports, at an angle of 15°, Art. no. 12.047.000

without tool holder	–	<b>15.315.XXX</b>
112 holders ISO-SK 40	B	<b>15.635.XXX</b>
64 holders ISO-SK 50	F	<b>15.636.XXX</b>
80 holders HSK 63 A+C+E/80 B+D+F	E	<b>18.395.XXX</b>



4 Tool cradle,  
2 Drawers (front heights 100 / 150 mm, load capacity 200 kg),  
1 Pull-out shelves (200 kg), including single-drawer opening system

without tool holder	–	<b>15.317.XXX</b>
56 holders ISO-SK 40	B	<b>15.639.XXX</b>
32 holders ISO-SK 50	F	<b>15.640.XXX</b>
40 holders HSK 63 A+C/80 B+D	E	<b>15.962.XXX</b>



### Fully extendable drawers

- load capacity 200 kg
- perfectly smooth running through differential pull-out without a crossbar
- details see p. 40



### Insert frames and pairs of frame supports

- insert frames can be used in cabinets, drawers and transport units
- tool cradles horizontal or at a slight incline, can easily be attached to vertical pull-outs, table stands, transport units and cabinets without screws
- for quick and safe access

» Partitioning schemes see p. 101

» Please contact us for more configuration options





## NC transport unit

**W** → 1077 mm    **D** ↗ 514 mm    **H** ↑ 927 mm    Specification to suit size **36 × 27 E**

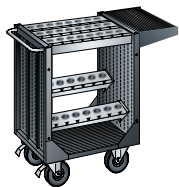

**Specification**  
 1 rack on the front, including PVC ribbed mat,  
 1 insert frame with pair of frame supports,  
 2 tool cradle with pair of frame supports, angled 15°  
 wheel diameter Ø 160 mm, rubber castors, load capacity 540 kg

Holder type	Partitioning schemes	Art. no.
without tool holder	–	15.419.XXX
40 holders ISO-SK 40	B	18.364.XXX
25 holders ISO-SK 50	F	18.365.XXX
30 holders HSK 63 A+C+E/80 B+D+F	E	18.368.XXX

**W** → 1080 mm    **D** ↗ 692 mm    **H** ↑ 970 mm    Specification to suit size **36 × 36 E**

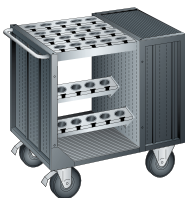

**Specification**  
 1 insert frame with pair of frame supports,  
 2 tool cradle with pair of frame supports, angled 15°,  
 2 adjustable shelves including PVC ribbed mat  
 wheel diameter Ø 200 mm, rubber castors, load capacity 800 kg

Holder type	Partitioning schemes	Art. no.
without tool holder	–	15.420.XXX
48 holders ISO-SK 40	B	18.369.XXX
30 holders ISO-SK 50	F	18.370.XXX
36 holders HSK 63 A+C+E/80 B+D+F	E	18.373.XXX

## NC bench stand

**W** → 588 mm    **D** ↗ 413 mm    **H** ↑ 345 mm    Specification to suit size **36 × 27 E**

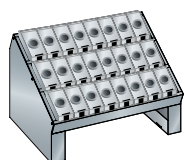

**Specification**  
 With screwed in insert frame for 3 strips.  
 Specification: steel sheet.  
 Colour: grey, NCS S 4502-B.  
 Side elements: as per colour chart

Holder type	Partitioning schemes	Art. no.
without tool holder	–	12.959.XXX
24 holders ISO-SK 40	B	15.431.XXX
15 holders ISO-SK 50	F	15.432.XXX
18 holders HSK 63 A+C+E/80 B+D+F	E	18.353.XXX



➤ Partitioning schemes see p. 101

➤ Please contact us for more configuration options



# WELL ORGANISED

Thanks to the wide range of combination options, each workstation can be individually equipped with LISTA workbenches to optimise space. The combinable workbench tops, drawer cabinets, power unit cabinets, vices and rear panels can be organised to create optimum working conditions. The latest findings in ergonomics are incorporated and everything is delivered to the highest LISTA quality even for the most demanding working environments in workshops and heavy industry.



## The right solution for every need



**move workstations**  
see p. 110



**Workbenches**  
see p. 116



**Hexagonal workbenches**  
see p. 148



**Compact workbenches**  
see p. 150



**System workbenches**  
see p. 152



**Assembly trolley**  
see p. 156



**Test and inspection workstations**  
see p. 158

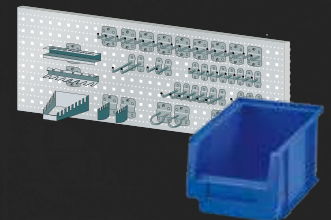

**Storage containers and keyhole hooks**  
see p. 162



**Desk chairs**  
see p. 164

**+ The utmost stability**  
Workbench load capacity up to 3 t, workbench tops extremely robust and resistant

**+ Great design diversity**  
thanks to the wide range of components, substructures, materials and surfaces

**+ Ergonomics and health**  
with height-adjustable workbench legs for optimum working heights and leg room – also available for our modular superstructure system

**+ Easily adaptable to new working environments**  
Flexible integration and reconfiguration of all components in the modular system

**+ Fully mobile**  
when fitted with rubber or nylon castors for mobile use

**+ move workstation system**  
electrically height-adjustable workstations with load capacities of 300–400 kg for a wide range of requirements and applications, see p. 110–115

**+ Fast and easy assembly**  
thanks to countertops with pre-assembly (incl. threaded inserts and bolts) for fastening all substructures and drawer cabinets

**>> General benefits of the LISTA drawer cabinets**  
See p.38/39

## Three into one

Whether heavy duty or the assembly area - with the LISTA workstation system you can configure the solution that suits all your tasks and requirements. This works according to a very simple principle. Each workstation is comprised of three main elements: substructure, universal superstructures and worktops. These can be individually equipped and expanded to provide total flexibility.



### 1 Substructures

Depending on the application and area of application, you can choose between substructures in four variants.

From p. 112



Move workstation frame in H design, electrically adjustable



Move workstation foot in H design, electrically adjustable



Move workstation frame in C design, height-adjustable



Workbench leg assembly, fixed or height-adjustable



### 3 Universal superstructures

Combine substructures and worktops freely and flexibly with the universal superstructures of the LISTA system. Numerous modules and accessories are available from the rear panel to the monitor holder.

See p. 132



### 2 Worktops

The LISTA workstation system offers you a wide range of high-quality worktops:

- Eight standard materials for every purpose
  - Six standard widths and five standard depths
- Other plate types and dimensions on request.

See p. 124

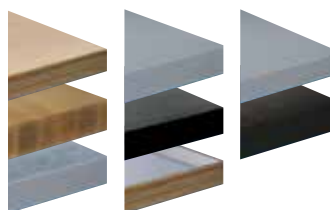

# 1 move workstation system

**LISTA's workstation system range offers an all-in-one solution for optimising workstations and workflows.** Regardless of whether it's an individual table, multiple workstations or a team environment: the seamless integration of components turns simple workstations into functional system solutions for optimum ergonomics and cost-effectiveness.

## + Utmost stability

up to 300 kg (move C design) or 400 kg (move H design) weight loading, H design is characterised by maximum rigidity

## + User-friendly and ergonomic

freely variable electrical height adjustment with workstation frames (H or C design) or workstation feet (H design). Programmable control for storing table heights

## + Space-saving and well-organised storage

in freely combinable and configurable LISTA drawer cabinets

## + Perfect cable management

thanks to cable trays and cable guide clip

## + Fully mobile

when fitted with rubber or nylon castors for mobile use

## >> Universal superstructures

see p. 132

## >> Desk chairs

see p. 164 – 167

## >> General benefits of the LISTA drawer cabinets

see p. 38/39

## + Benefits of ergonomic workstation design



» Desk chairs see p. 164–167

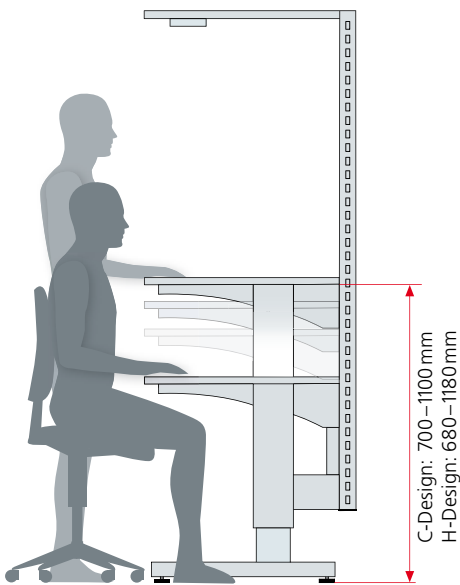

- Simplified workflows resulting in quality improvements and a reduction in error rates
- 20% increased efficiency
- Increased performance potential and reduced processing times
- Healthier work environment and cost reduction in the long term thanks to fewer disruptions

### Optimum reach area

Based on average human body dimensions, there are four access zones on the table worktop with different priorities:

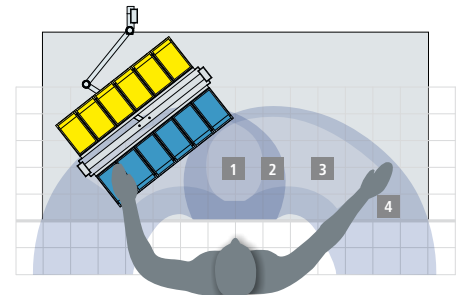

Optimum arrangement of grab containers in zone 2 and 3 right beside the workpiece

- 1 The working centre:**  
Both hands work in the direct field of vision
- 2 Extended working centre:**  
Both hands reach all areas of this zone
- 3 One-hand zone:**  
Parts and tools are within easy reach of one hand
- 4 Extended one-hand zone:**  
Outermost usable zone

### Mobility – humans as a standard

Assembly workstations should be fundamentally designed for sitting as well as standing positions. If alternating between sitting and standing positions is not possible, a sitting position is preferable.

#### Features

	move H design		move C design
	H frame	H leg	C frame
Load capacity	400 kg	400 kg	300 kg
Adjustment range (without top)	680–1180 mm	680–1180 mm	700–1100 mm
Workbench depth	800/1000 mm	750–1000 mm	620–800 mm
Rigidity in the front countertop area	++	++	+
Knee clearance	+	+	++
Countertop thickness	30 mm	40/50 mm	30 mm
Countertop widths	1000/1500/2000	flexible up to 2500*	1200/1500/2000

\*The max. top width depends on the load capacity. For load capacities see p. 130/131.

### Lighting

Good lighting helps to reduce error rates caused by overstrained eyes. Employee performance and production quality rise. The required light intensity must be adapted to the assembly activities.

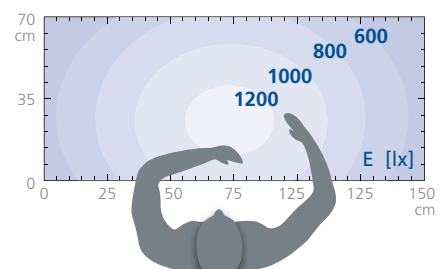

## Substructures

Does your workstation require a particularly stable and robust substructure, and must it be accessible or easily height-adjustable? The LISTA workstation system has flexible and configurable modules in four variants tailored to the requirements of different areas of application. In addition to the two electrically adjustable LISTA move H design workstation frames and legs, our system also includes the C design of the movable workstation frame, which is especially suitable for assembly and control tasks, as well as the classic workbench leg assembly for high loads in workshops and production.

### move workstation frame, H design, electrically height-adjustable



4-legged tubular construction incl. connection for universal superstructures and adjustable legs. Lifting force: Max. 400 kg with evenly distributed load. Lift: 500 mm. Max. speed 23 mm/s. Incl. control and operating unit. Input via system plug. Colour: Lifting unit RAL 9006 white aluminium, outer profile according to colour chart. Without connecting cable. Country-specific connection cable must be ordered separately. See p. 144. Countertop must be ordered with pre-assembly, see page 125. Incl. integrated guide rail for mounting the optional support pillars, see page 138.

W →	D ↗	H ↑	for top W × D mm	Top thickness mm	Art. no.
950	785	680–1180	1000 × 800	30	88.226.XXX
950	985	680–1180	1000 × 1000	30	88.227.XXX
1450	785	680–1180	1500 × 800	30	88.228.XXX
1450	985	680–1180	1500 × 1000	30	88.229.XXX
1950	785	680–1180	2000 × 800	30	88.230.XXX
1950	985	680–1180	2000 × 1000	30	88.231.XXX

Height without countertop

#### Reinforcement angle for move workstation frame, H design

For mounting on the workbench top and reinforcing the guide rails to withstand high loads..  
D × H: 190 × 272 mm Colour: as per colour chart.



Fastening bracket

Art. no.

88.237.XXX

#### Suspension adapter for hanging drawer cabinets

Can be mounted either on the left or right underneath the countertop. Model: sheet steel.  
Colour: as per colour chart.

for frame depth mm	width drawer cabinet	depth drawer cabinet	Art. no.
785	18 E	27 E / 36 E	88.238.XXX
785	27 E	27 E / 36 E	88.239.XXX
985	18 E	27 E / 36 E	88.240.XXX
985	27 E	27 E / 36 E	88.241.XXX



#### Keyboard drawer

Pull-out shelf with rear stop. For H design  
(frame and leg). W × D: 550 × 370 mm. Max. load: 20 kg.  
Model: sheet steel. Colour: as per colour chart.

Art. no.

Pull-out keyboard for substructure 550/370

88.242.XXX

#### Factory assembly

For workstation frame move, H design, with countertop. Without superstructures and base cabinets.

Art. no.

Electrically height-adjustable workstation frame installation

88.246.000



## move workstation leg, H design, electrically height-adjustable

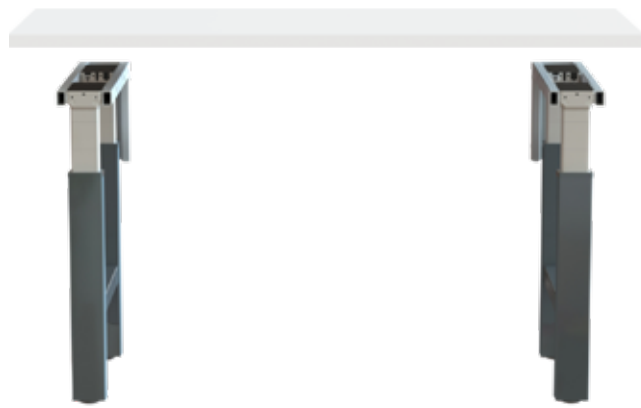

Lifting force: 200 kg/leg with an evenly distributed load. Lift: 500 mm. Speed max. 23 mm/s.  
 Colour: Lifting unit RAL 9006 white aluminium, outer profile according to colour chart.  
 Scope of delivery: 1 unit For your substructure, you need two move work legs, H design, and a 2-fold/4 K control unit. Without connection cable. Country-specific connection cable must be ordered separately, see page 144. Countertop must be ordered with pre-assembly, see page 125. Linking of several legs on request.

W →	D ↗	H ↑	for top depth mm	Top thickness mm	Art. no.
90*	725	680–1180**	750/800	40–50	<b>88.200.XXX</b>
90*	925	680–1180**	1000	40–50	<b>88.201.XXX</b>

\*Corresponds to leg width (max. width 175 mm) \*\*Height without countertop



### Convenient operating element

Display of table height. Four favourite positions can be saved. Manual height storage.

Art. no.  
**88.203.000**

Convenient operating element



### Control unit two-fold/4K

Complete set incl. basic control elements (up/down control), cable guide chain and connection cable between control unit and motors. For controlling the move workstation leg, H design. Mains voltage 100 – 240V AC, 50–60Hz, IP20, overload protection, soft start/stop function, connection via Wieland system plug, colour: black

Art. no.  
**88.202.000**

Control unit set 2-fold/4K



### Cross brace for shelves

Including fastening material. Model: sheet steel. Colour: as per colour chart. Scope of delivery: 1 unit

for top width (2 legs) mm	for leg distance (centre) mm	Strut length mm	Art. no.
1500	1300	1224	<b>43.233.XXX</b>
2000	1800	1724	<b>43.236.XXX</b>
2500	2300	2224	<b>40.242.XXX</b>



### Workstation anti-tilting device

For increasing the tilt protection or securing the workstation. Suitable for H frame and H leg.

### H design leg extension

2 profiles

for top depth mm	Art. no.
750/800	<b>88.312.XXX</b>
1000	<b>88.313.XXX</b>



### Leg extension incl. castors

For the mobile version of a move workstation in H design, load capacity 300 kg. Suitable for H frame and H leg.

### Floor anchoring, galvanised (2 pcs.)

**88.314.000**

### Leg extension incl. push handle and castors\*

2 leg extensions

4 double castors (Ø 80 mm, steerable with 2 brakes)

for top depth mm	Art. no.
750/800	<b>88.310.XXX</b>
1000	<b>88.311.XXX</b>

\* Increases table height by approx.



### Multiplex/synthetic resin storage shelf

Suitable for attachment between two move workbench legs, H design. Capacity 20 kg. Including fastening material.

#### Multiplex 20 mm

for top width mm	W →	D ↗	H ↑	for depth workbench leg move mm	Art. no.
1500	1420	520	20	725	<b>88.213.000</b>
2000	1920	520	20	725	<b>88.214.000</b>
1500	1420	720	20	925	<b>88.216.000</b>
2000	1920	720	20	925	<b>88.217.000</b>
Special size (max. W × D: 2500 × 1250 mm)					<b>88.218.000</b>

#### Resin 22 mm

for top width mm	W →	D ↗	H ↑	for depth workbench leg move mm	Art. no.
1500	1420	520	22	725	<b>88.220.000</b>
2000	1920	520	22	725	<b>88.221.000</b>
1500	1420	720	22	925	<b>88.223.000</b>
2000	1920	720	22	925	<b>88.224.000</b>
Special size (max. W × D: 2740 × 1200 mm)					<b>88.225.000</b>



## move workstation frame, C design

**With clamping screws**

Table legs height-adjustable using clamping screws. For top thickness: 30 mm.

W →	D ↗	H ↑	for top depth mm	for top width mm	Art. no.
1030	600	700–1100	620–800	1200	<b>65.300.XXX</b>
1360	600	700–1100	620–800	1500	<b>65.301.XXX</b>
1780	600	700–1100	620–800	2000	<b>65.302.XXX</b>

Height without countertop

**With electric motor**

Table substructure can be electrically adjusted to any height. The operating unit can be mounted on the left or right (on the right as standard). A connection cable is required for operation, see p. 144. For top thickness: 30 mm.

W →	D ↗	H ↑	for top depth mm	for top width mm	Art. no.
1030	600	700–1100	620–800	1200	<b>65.204.XXX</b>
1360	600	700–1100	620–800	1500	<b>65.205.XXX</b>
1780	600	700–1100	620–800	2000	<b>65.206.XXX</b>

Height without countertop

**Programmable control system**

Optionally available for automatic adjustment of individual installation heights



Programmable control system

Art. no.  
**65.232.000**

**With hand crank**

Table substructure can be mechanically adjusted to any height with the hand crank. The hand crank is removable (can be mounted on the left or right). For top thickness: 30 mm.

W →	D ↗	H ↑	for top depth mm	for top width mm	Art. no.
1030	600	700–1100	620–800	1200	<b>65.303.XXX</b>
1360	600	700–1100	620–800	1500	<b>65.304.XXX</b>
1780	600	700–1100	620–800	2000	<b>65.305.XXX</b>

Height without countertop

**Caster set C design**

For fastening to existing move workstation frame, C design. Designed as temporary roll support to move the workstation quickly and effortlessly. Adjustment range downwards reduced by approx. 25 mm. Incl. push handle.

Fixed Table  
(castors up)

Mobile Table  
(castors down)

Caster set	Art. no.
	<b>74.991.000</b>

## Accessories

W →	D ↗	H ↑	Art. no.
<b>Pull-out keyboard drawer for table frame</b>			
Load: 20 kg Drawer width: 520 mm.			
560	420	75	<b>65.297.XXX</b>

**PC compartment**

Mounting on bench frame. Do not exceed max. PC height: 500 mm.

76	410	40	<b>65.144.XXX</b>
----	-----	----	-------------------

**Bracket**

Bracket 18 × 27 E for fastening the drawer cabinets to either the left or the right of the table frame. Specification: sheet steel. Colour: as per colour chart. Drawer cabinets 18 × 27 E, see p. 46 onwards.

411	-	-	<b>65.074.XXX</b>
-----	---	---	-------------------

**! Caution**

The maximum load for the H design as well as for the C design applies with an evenly distributed load (incl. countertop and add-on elements).

# move workstation planning information

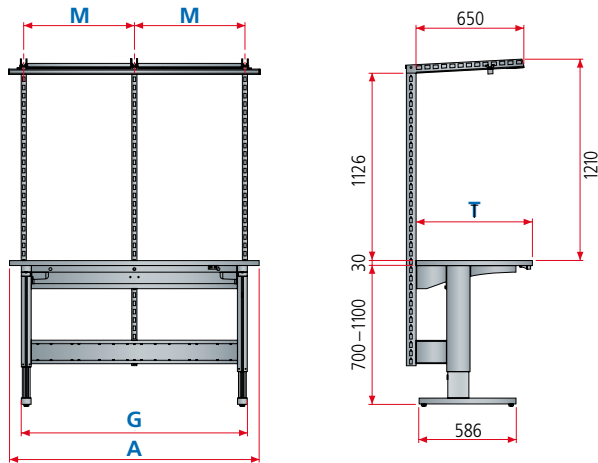

Workstation frame, C design				
Worktop width mm	<b>A</b>	1200	1500	2000
Worktop depth mm	<b>T</b>	700	700	700
Table frame width mm*	<b>G</b>	1030	1360	1780
Possible module widths mm	<b>M</b>	s. p. 136	s. p. 136	s. p. 136
Max. superstructure module widths mm	<b>M</b>	1000	1330	1665

\* Dimension G = Exterior side of support to exterior side of support

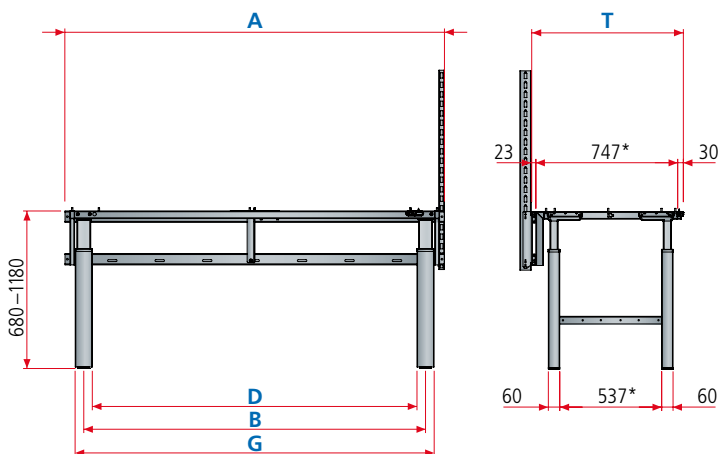

Workstation frame, H design				
Worktop width mm	<b>A</b>	1000	1500	2000
Worktop depth mm	<b>T</b>	800/1000	800/1000	800/1000
Table frame width mm*	<b>G</b>	950	1450	1950
Number of leg assemblies		2	2	2
Width between supports mm	<b>B</b>	800	1300	1800
Storage shelf		920	1420	1910
Clear width mm	<b>D</b>	710	1210	1710
Clear crossbeam width mm		720	1220	1720

\* when using a top depth of 800 mm

\*\*without guide rail

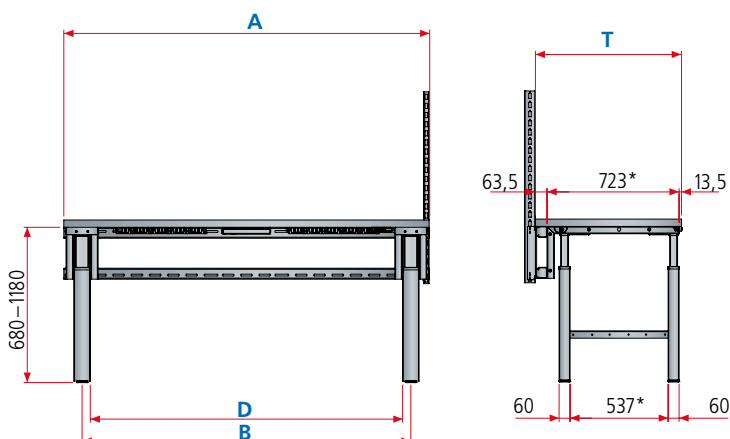

Workstation frame, H design						
Worktop width mm	<b>A</b>	1000	1500	2000	2500	3000
Worktop depth mm	<b>T</b>	800/1000	800/1000	800/1000	800/1000	800/1000
Number of leg assemblies		2	2	2	2	3
Width between supports mm	<b>B</b>		1300	1800	2300	1400
Storage shelf			1420	1920	2420	2 x 1460
Clear width mm	<b>D</b>		1210	1710	2210	1310
Clear crossbeam width mm			1220	1720	2220	1320

\* when 800 mm top depth is used



# 1 Workbenches

Thanks to the wide range of combination options, each workstation can be individually equipped with LISTA workbenches to optimise space. The combinable workbench tops, drawers and equipment cabinets, vices and rear panels can be organised to create optimum working conditions. The latest findings in ergonomics are incorporated and everything is delivered to the highest LISTA quality even for the most demanding working environments in workshops and heavy industry.

- 
- + Utmost stability**  
workbench load capacity up to 3 t, workbench top extremely robust and resistant
  - + Easy to use and highly ergonomic**  
with height-adjustable workbench legs for optimum working heights and leg room – also available for our modular superstructure system
  - + Fully mobile**  
when fitted with rubber or nylon castors for mobile use
  - + Fast and easy assembly**  
as the workbench tops have pre-drilled holes including threaded inserts (pre-assembled) for fastening all substructures and drawer cabinets
  - >> Universal superstructures**  
see p. 132
  - >> Benefits of LISTA drawer cabinets**  
see p. 38/39
  - >> Desk chairs**  
see p. 164–167

## + Various substructures



### Workbench legs

- sturdy steel plate construction
- welded from steel profiles
- with holes for attaching worktops and shelves



### Castors for mobility

- for mobile workbenches
- fixed castors and swivel castors including brake mechanisms
- nylon or rubber-coated wheels for soft and hard floors



### Vice cabinet

- can be fitted with any desired vice
- can easily be folded away beneath the workbench



### Power unit and drawer cabinets

- prepared for the installation of the power and air supply by the customer at the workstation

» For order information, please contact us.

## Order preconfigured models

» Pages 118–120

**1.** Select workbench

» Page 132

**3.** Superstructures and accessories

## ... or configure and order workbenches individually

» Pages 124–129

**1.** Workbench top

- Select size and material of workbench top
- 5 different materials with various dimensions are available
- When assembling preconfigured workbenches, additional fastening materials and threaded inserts (pre-assembled) must be ordered for each component.

» Page 132

**2.** Top accessories

- Select worktop accessories
- Select from items such as rear panels and side panels, storage shelves, fastening material and pre-assemblies

**3.** Substructures and accessories

- Select the substructure
- You can select from workbench leg assemblies and drawer cabinets in various sizes
- Selecting the substructure includes a choice of the required locking system (for cabinets) and colour

**4.** Superstructures and accessories

- Select the superstructures for the workbench
- Customise your workbench with support pillars, appliance rails, lighting, rear panels, shelves and much more



Art. no. **78.875.514**  
 Frame: Light grey, RAL 7035.  
 Fronts: Light blue, RAL 5012  
 (excluding optional beech instead  
 of Multiplex worktop)



## D 700 mm

Workbenches fitted with drawer cabinets in sizes\* **27 × 27 E**

**18 × 27 E** **27 × 27 E** **36 × 27 E**

 459 × 459 mm



W →	D ↗	H ↑	 kg	Number of drawers (mm)		Art. no. 
1500	700	840	Multiplex	600	-	<b>78.389.XXX</b>
1500	700	890	Multiplex	600	-	<b>78.395.XXX</b>
2000	700	840	Multiplex	360	-	<b>78.394.XXX</b>
2000	700	890	Multiplex	360	-	<b>78.396.XXX</b>
1500	700	840	Multiplex	600	<b>3: 1 × 50 / 1 × 100 / 1 × 150</b>	KEY Lock <b>78.397.XXX</b>
1500	700	890	Multiplex	600	<b>3: 1 × 50 / 1 × 100 / 1 × 150</b>	KEY Lock <b>78.875.XXX</b>
2000	700	840	Multiplex	360	<b>3: 1 × 50 / 1 × 100 / 1 × 150</b>	KEY Lock <b>78.398.XXX</b>
2000	700	890	Multiplex	360	<b>3: 1 × 50 / 1 × 100 / 1 × 150</b>	KEY Lock <b>78.876.XXX</b>
1500	700	840	Multiplex	1500	<b>4: 2 × 100 / 1 × 200 / 1 × 300</b>	KEY Lock <b>78.879.XXX</b>
2000	700	840	Multiplex	800	<b>4: 2 × 100 / 1 × 200 / 1 × 300</b>	KEY Lock <b>78.885.XXX</b>
1500	700	840	Multiplex	1500	<b>5: 1 × 50 / 2 × 100 / 1 × 150 / 1 × 300</b>	KEY Lock <b>78.888.XXX</b>
2000	700	840	Multiplex	800	<b>5: 1 × 50 / 2 × 100 / 1 × 150 / 1 × 300</b>	KEY Lock <b>78.889.XXX</b>
1500	700	890	Multiplex	1500	<b>5: 2 × 100 / 1 × 150 / 2 × 200</b>	KEY Lock <b>78.892.XXX</b>
2000	700	890	Multiplex	800	<b>5: 2 × 100 / 1 × 150 / 2 × 200</b>	KEY Lock <b>78.893.XXX</b>
1500	700	890	Multiplex	1500	<b>6: 1 × 50 / 2 × 100 / 2 × 150 / 1 × 200</b>	KEY Lock <b>78.896.XXX</b>
2000	700	890	Multiplex	800	<b>6: 1 × 50 / 2 × 100 / 2 × 150 / 1 × 200</b>	KEY Lock <b>78.897.XXX</b>

\* These workbench examples are fitted with size 27 × 27 E drawer cabinets. Each workbench is also available with drawer cabinets in sizes:

18 × 27 E = 306 × 459 mm (W × D)  
 36 × 27 E = 612 × 459 mm (W × D)

## Workbenches

With Multiplex top, including pre-assembly and fastening material. Drawer cabinet can be fitted on either the right or the left.

Multiplex top thickness **40 mm**  
 Workbench leg height 800/850 mm  
 Drawer cabinet width 564 mm  
 Drawer cabinet depth 572 mm  
 Drawer load capacity 75 kg

For load specifications see p. 130/131

## Universal superstructures

Whether workstation system, workbench, compact workbench, team or testing and inspection workstations – the compatible, modular superstructure system is unique due to its flexibility and the variety of ways it can be put together.



When ordering a workbench from these two pages with **CODE Lock**, please add the suffix "**C**" or for **RFID** or **AUTO Lock "F"** or "**A**" in addition to the article number from the table (e.g. **78.897.XXX.C**).

» Other locking systems  
 see pp. 28–31



**S**

Art. no. **39.721.010**  
Light blue, RAL 5012

**D** **750/800 mm**

**Workbenches fitted with drawer cabinets in sizes\* 27 x 36 E**

459 x 612 mm



W	D	H		kg	Number of drawers (mm)		Art. no.
1500	750	840	Multiplex	600	-	-	<b>40.961.XXX</b>
1500	750	890	Multiplex	600	-	-	<b>78.900.XXX</b>
1500	750	740-1090**		600			<b>78.265.XXX</b>
1500	800	850	Beech	800	-	-	<b>88.141.XXX</b>
1500	800	900	Beech	800	-	-	<b>78.902.XXX</b>
1500	800	750-1100**		800			<b>78.266.XXX</b>
2000	750	840	Multiplex	360	-	-	<b>40.963.XXX</b>
2000	750	890	Multiplex	360	-	-	<b>78.901.XXX</b>
2000	750	740-1090**		360			<b>78.267.XXX</b>
2000	800	850	Beech	500	-	-	<b>88.143.XXX</b>
2000	800	900	Beech	500	-	-	<b>78.903.XXX</b>
2000	800	750-1100**		500			<b>78.268.XXX</b>
1500	750	840	Multiplex	600	1: 1 x 150	KEY Lock	<b>40.934.XXX</b>
1500	750	890	Multiplex	600	1: 1 x 150	KEY Lock	<b>78.904.XXX</b>
1500	800	850	Beech	800	1: 1 x 150	KEY Lock	<b>59.189.XXX</b>
1500	800	900	Beech	800	1: 1 x 150	KEY Lock	<b>78.906.XXX</b>
2000	750	840	Multiplex	360	1: 1 x 150	KEY Lock	<b>40.936.XXX</b>
2000	750	890	Multiplex	360	1: 1 x 150	KEY Lock	<b>78.905.XXX</b>
2000	800	850	Beech	500	1: 1 x 150	KEY Lock	<b>59.191.XXX</b>
2000	800	900	Beech	500	1: 1 x 150	KEY Lock	<b>78.907.XXX</b>
1500	750	840	Multiplex	600	3: 1 x 50 / 1 x 100 / 1 x 150	KEY Lock	<b>59.005.XXX</b>
1500	750	890	Multiplex	600	3: 1 x 50 / 1 x 100 / 1 x 150	KEY Lock	<b>78.908.XXX</b>
1500	750	740-1090**		600	3: 1 x 50 / 1 x 100 / 1 x 150	KEY Lock	<b>78.269.XXX</b>
1500	800	850	Beech	800	3: 1 x 50 / 1 x 100 / 1 x 150	KEY Lock	<b>59.213.XXX</b>
1500	800	900	Beech	800	3: 1 x 50 / 1 x 100 / 1 x 150	KEY Lock	<b>78.912.XXX</b>
1500	800	750-1100**		800	3: 1 x 50 / 1 x 100 / 1 x 150	KEY Lock	<b>78.270.XXX</b>
2000	750	840	Multiplex	360	3: 1 x 50 / 1 x 100 / 1 x 150	KEY Lock	<b>59.007.XXX</b>
2000	750	890	Multiplex	360	3: 1 x 50 / 1 x 100 / 1 x 150	KEY Lock	<b>78.910.XXX</b>
2000	750	740-1090**		360	3: 1 x 50 / 1 x 100 / 1 x 150	KEY Lock	<b>78.271.XXX</b>
2000	800	850	Beech	500	3: 1 x 50 / 1 x 100 / 1 x 150	KEY Lock	<b>59.215.XXX</b>
2000	800	900	Beech	500	3: 1 x 50 / 1 x 100 / 1 x 150	KEY Lock	<b>78.914.XXX</b>
2000	800	750-1100**		500	3: 1 x 50 / 1 x 100 / 1 x 150	KEY Lock	<b>78.272.XXX</b>

**i**



When ordering a workbench from these two pages with **CODE Lock**, please add the suffix **"C"** or for **RFID** or **AUTO Lock "F"** or **"A"** in addition to the article number from the table (e.g. **78.897.XXX.C**).

Locking systems see p. 28-31

**S**

**S**

**S**

**S**



**Multiplex top**

**Thickness 40 mm.** Made of steamed beech veneers glued in multiple layers, waterproof, with bevelled edges and sanded, oiled and waxed surface. The top is splash-proof, dirt-repellent and largely impervious to oil and grease.

**S**

**S**

**S**

**S**







**Beechwood top**

**Thickness 50 mm.** Made of glued steamed beech beams, waterproof, with bevelled edges and a sanded, oiled and waxed surface. The top is splash-proof, dirt-repellent and largely impervious to oil and grease.



**D**  **750/800 mm**
**Workbenches fitted with drawer cabinets in sizes\* 27×36 E**
 459×612 mm

W→	D↗	H↑			Number of drawers (mm)		Art. no. 
1500	750	840	Multiplex	600	4: 1×50 / 2×100 / 1×200	KEY Lock	<b>59.019.XXX</b>
1500	750	890	Multiplex	600	4: 1×50 / 2×100 / 1×200	KEY Lock	<b>78.916.XXX</b>
1500	800	850	Beech	800	4: 1×50 / 2×100 / 1×200	KEY Lock	<b>59.008.XXX</b>
1500	800	900	Beech	800	4: 1×50 / 2×100 / 1×200	KEY Lock	<b>78.920.XXX</b>
2000	750	840	Multiplex	360	4: 1×50 / 2×100 / 1×200	KEY Lock	<b>59.040.XXX</b>
2000	750	890	Multiplex	360	4: 1×50 / 2×100 / 1×200	KEY Lock	<b>78.918.XXX</b>
2000	800	850	Beech	500	4: 1×50 / 2×100 / 1×200	KEY Lock	<b>59.013.XXX</b>
2000	800	900	Beech	500	4: 1×50 / 2×100 / 1×200	KEY Lock	<b>78.922.XXX</b>
1500	750	840	Multiplex	1500	4: 2×100 / 1×200 / 1×300	KEY Lock	<b>59.039.XXX</b>
1500	800	850	Beech	1500	4: 2×100 / 1×200 / 1×300	KEY Lock	<b>59.009.XXX</b>
2000	750	840	Multiplex	800	4: 2×100 / 1×200 / 1×300	KEY Lock	<b>59.041.XXX</b>
2000	800	850	Beech	1000	4: 2×100 / 1×200 / 1×300	KEY Lock	<b>59.014.XXX</b>
1500	750	840	Multiplex	1500	5: 1×50 / 2×100 / 1×150 / 1×300	KEY Lock	<b>40.970.XXX</b>
1500	800	850	Beech	1500	5: 1×50 / 2×100 / 1×150 / 1×300	KEY Lock	<b>39.719.XXX</b>
2000	750	840	Multiplex	800	5: 1×50 / 2×100 / 1×150 / 1×300	KEY Lock	<b>40.972.XXX</b>
2000	800	850	Beech	1000	5: 1×50 / 2×100 / 1×150 / 1×300	KEY Lock	<b>39.721.XXX</b>
1500	750	890	Multiplex	1500	5: 2×100 / 1×150 / 2×200	KEY Lock	<b>78.924.XXX</b>
1500	800	900	Beech	1500	5: 2×100 / 1×150 / 2×200	KEY Lock	<b>78.928.XXX</b>
2000	750	890	Multiplex	800	5: 2×100 / 1×150 / 2×200	KEY Lock	<b>78.926.XXX</b>
2000	800	900	Beech	1000	5: 2×100 / 1×150 / 2×200	KEY Lock	<b>78.930.XXX</b>
1500	750	890	Multiplex	1500	6: 1×50 / 2×100 / 2×150 / 1×200	KEY Lock	<b>78.932.XXX</b>
1500	800	900	Beech	1500	6: 1×50 / 2×100 / 2×150 / 1×200	KEY Lock	<b>78.936.XXX</b>
2000	750	890	Multiplex	800	6: 1×50 / 2×100 / 2×150 / 1×200	KEY Lock	<b>78.934.XXX</b>
2000	800	900	Beech	1000	6: 1×50 / 2×100 / 2×150 / 1×200	KEY Lock	<b>78.938.XXX</b>
2000	750	840	Multiplex	1500	<b>4 left:</b> 2×100 / 1×200 / 1×300	KEY Lock	<b>59.051.XXX</b>
2000	800	850	Beech	1500	<b>5 right:</b> 1×50 / 2×100 / 1×150 / 1×300	KEY Lock	<b>59.018.XXX</b>
2000	750	890	Multiplex	800	<b>5 left:</b> 2×100 / 1×150 / 2×200	KEY Lock	<b>78.940.XXX</b>
2000	800	900	Beech	1000	<b>6 right:</b> 1×50 / 2×100 / 2×150 / 1×200	KEY Lock	<b>78.942.XXX</b>

18×27 E	27×27 E	36×27 E
18×36 E	<b>27×36 E</b>	36×36 E

\* These workbench ordering examples are equipped with drawer cabinets in size 27×36 E. Each workbench is also available with drawer cabinets in sizes:

18×27 E = 306×459 mm (W×D)  
 27×27 E = 459×459 mm (W×D)  
 36×27 E = 612×459 mm (W×D)  
 18×36 E = 306×612 mm (W×D)  
 36×36 E = 612×612 mm (W×D)

**S** **Workbenches**

With Multiplex or beech top including pre-assembly and fastening material. Drawer cabinet can be fitted on either the right or the left.

Multiplex top thickness	<b>40 mm</b>
Beech top thickness	<b>50 mm</b>
Workbench leg height	800/850 mm
height-adjustable**	700–1050 mm
Drawer cabinet width	564 mm
Drawer cabinet depth	725 mm
Drawer load capacity	75 kg

For load specifications see p. 130/131

**S** **LISTA fast delivery program**

These LISTA products in light blue (.010) and light grey (.020) are available ex-works.

**.010** Light blue  
RAL 5012

**.020** Light grey  
RAL 7035





Art. no. **69.853.200**  
Top-mounted cabinet with aluminium roller shutters anthracite, RAL 7016



### Housing

- Sturdy steel structure
- Version without shelf as top-mounted cabinet (direct mounting on countertop) or alternatively with shelf as overhead cabinet, see p. 186/187



### Handle

- Integrated handle
- Locking mechanism has no impact on usable depth
- Locking with KEY lock, keyed alike possible on request.

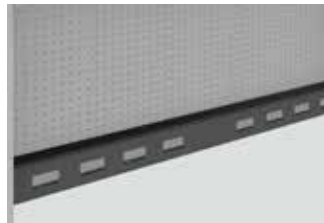

### Power conduit

- Optionally integrated power conduit
- Configurable with power modules (see page 145)

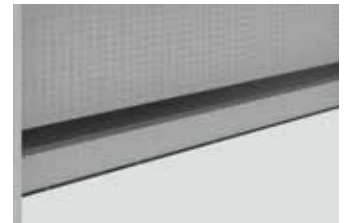

### Adjustable shelf

- Optional adjustable shelf
- Adjustment increment: 25 mm

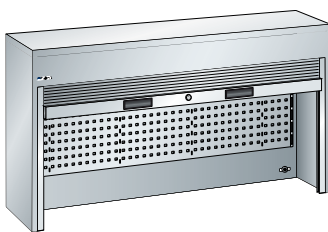

### Roller shutter cabinet top-mounted cabinet

Aluminium roller shutters with spring-loaded winding ensures a large usable depth (215 mm) and safe operation (self-locking). The sturdy steel housing and the aluminium roller shutters ensure stable, secure storage. Punch-outs intended for power supply. Mounted directly on countertop.

Perforated rear panel for using perforated wall hooks (see p. 163), with square perforation 10 × 10 and 38 mm divisions.

Further versions with a height of 800 mm (with shelf) are attached to the support pillar via perforated rear panel (see p. 186/187).

W →	D ↗	H ↑	Model	Art. no.
1500	250	1050	without shelf	<b>69.852.XXX</b>
2000	250	1050	without shelf	<b>69.853.XXX</b>

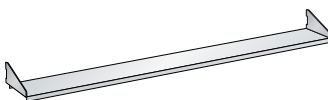

### Adjustable shelf

Optional adjustable shelf  
Depth 175 mm

W →	D ↗		Art. no.
1500	175	20	<b>69.854.XXX</b>
2000	175	20	<b>69.855.XXX</b>

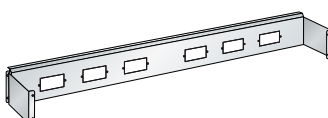

### Power conduit set

Integrated cable conduit solution. Designed for installation in roller shutter cabinet. The power conduit can be equipped with the power modules. See page 145

for width mm	for power module mm	Art. no.
1500	6 ×	<b>89.022.XXX</b>
2000	8 ×	<b>89.023.XXX</b>





### Workbench legs, stationary, fixed height and height-adjustable

The LISTA workbench leg assembly is a rugged steel construction, welded together with extruded profiles, with holes for fastening the top. The feet can be anchored to the floor through a hole in the base plate. Load capacity 400 kg. Please note the maximum clear width on page 130. Specification: sheet steel. Colour: as per colour chart.

Height mm	For top depth mm	Top thickness mm	Width mm	Depth mm	Art. no. 
800	700	40–50	80	675	43.101.XXX
850	700	40–50	80	675	43.176.XXX
700–1050*	700	40–50	80	675	43.186.XXX
800	750, 800	40–50	80	725	43.111.XXX
850	750, 800	40–50	80	725	43.179.XXX
700–1050*	750, 800	40–50	80	725	43.231.XXX

\* Height-adjustable in 25 mm increments.



### Levelling plates

For height compensation. For precise alignment, even on uneven floors. Description: PVC. Colour: grey. Dimensions: 90 × 90 mm (W × D)

Thickness mm	Art. no.
1	338.146.000
2	338.147.000
4	304.309.000

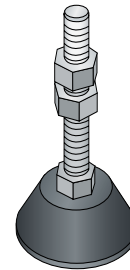

### Levelling foot



1 × levelling foot, ø 50 mm, adjustment range 45–90 mm. Including fastening material. Two levelling feet are required per workbench leg assembly. Description: plastic, black.

Art. no.  
345.040.000



### ! Workbench leg assemblies, mobile and height-adjustable

Option to select nylon or rubber coated wheels, depending on the properties of the floor. Width: 80 mm. Depth: 725 mm. Height: 700–1050 mm. Please note the maximum clear width on page 130. Specification: sheet steel. Colour: as per colour chart.

Specification	 kg	Wheel Ø mm	Art. no. 
with <b>push handle</b> , without castors	400	-	39.974.XXX
with <b>2 nylon fixed castors</b>	200	100	39.770.XXX
with <b>2 rubber fixed castors</b>	200	100	39.965.XXX
with <b>2 nylon swivel castors, brakes</b>	200	100	39.771.XXX
with <b>2 rubber swivel castors, brakes</b>	200	100	39.966.XXX
with <b>2 nylon swivel castors, brakes, push handle</b>	200	100	39.973.XXX
with <b>2 rubber swivel castors, brakes, push handle</b>	200	100	39.972.XXX





### Cross brace

For stabilising the legs on a workbench (e.g. those on a mobile workbench). Including fastening material. Model: sheet steel. Colour: as per colour chart. Scope of delivery: 1 unit



### Cross brace for in-line installation

For connecting two workbenches (top with three work legs, 2-part strut). Including fastening material. Model: sheet steel. Colour: as per colour chart.

for top width (2 legs) mm	for leg distance (centre) mm	Strut length mm	Art. no. 	for top width (3 legs) mm	for leg distance (centre) mm	Strut length mm	Art. no. 
1500	1300	1224	43.233.XXX	2000	900	1648 (2 × 824)	40.833.XXX
2000	1800	1724	43.236.XXX	2500	1150	2148 (2 × 1074)	43.241.XXX
2500	2300	2224	40.900.XXX	3000	1400	2648 (2 × 1324)	43.242.XXX



### Drawer cabinets

Every workbench is available with drawer cabinets in sizes:

18 × 27 E = 306 × 459 mm (W × D)	18 × 36 E = 306 × 612 mm (W × D)
27 × 27 E = 459 × 459 mm (W × D)	27 × 36 E = 459 × 612 mm (W × D)
36 × 27 E = 612 × 459 mm (W × D)	36 × 36 E = 612 × 612 mm (W × D)

**18 × 27 E** **27 × 27 E** **36 × 27 E**

**18 × 36 E** **27 × 36 E** **36 × 36 E**

» Drawer cabinets see p. 38



### Mobile workbenches

must be fitted with a push handle according to the Product Safety Act. In addition, mobile workbenches must be fitted with a strut for stability.

### Storage shelves between workbench leg assemblies, 675 and 725 mm deep

Thickness 20 mm, maximum load capacity 20 kg. Specification: Multiplex top, pre-drilled, including fastening material.

D  Depth of storage shelves mm		560	610
For depth of workbench leg assemblies (mm)		675	725
Worktop width mm	Width mm	Art. no.	Art. no.
1500	1420	43.405.000	43.247.000
2000	1920	43.406.000	43.248.000
2500	2420	43.407.000	43.258.000
3000	2920*	43.408.000	43.259.000

\* Slotted (two-piece, 2 x 1460 mm), 3 workbench leg assemblies required.

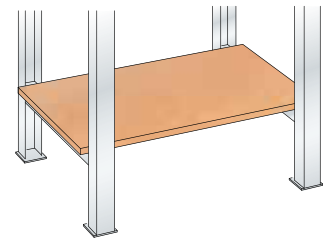

### Storage shelves between workbench leg assembly and cabinet, 675 and 725 mm deep

Thickness 20 mm, maximum load capacity 20 kg. Specification: Multiplex top, pre-drilled, including fastening material, without support bracket.

D  Depth of storage shelves mm		560	610
For depth of workbench leg assemblies (mm)		675	725
Depth of drawer cabinets (mm)/LISTA Unit		572/27 E	725/36 E
Worktop width mm	Width storage shelves mm	Art. no.	Art. no.
1500	835	43.409.000	43.266.000
2000	1335	43.410.000	43.267.000
2500	1835	43.411.000	43.271.000
3000	2335	43.431.000	43.272.000

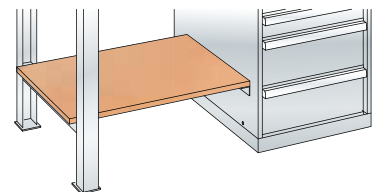

### Support bracket for storage shelf on drawer cabinet

Fastening material included. Specification: sheet steel. Colour: light grey, RAL 7035.

For storage shelf depth mm	Workbench depth mm	Art. no.
560	461	43.432.000
610	540	43.273.000

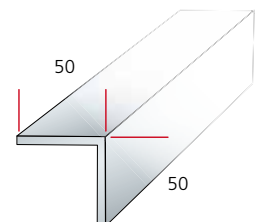

### CPU holder

CPU holder attached hanging to the workbench top (minimum top thickness 30 mm). Side holder adjustable for equipment widths of about 100 to 220 mm. Including fastening material. Description: sheet steel. Colour: according to colour chart.

Width mm	Depth mm	Height mm	Art. no.
250	460	510	340.243.XXX

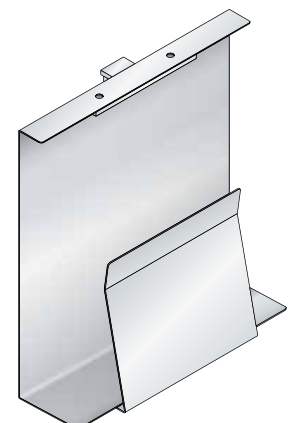

### CPU holder pre-assembly

Pre-assembly (pre-drilled holes) excluding fastening material.

Pre-assembly position	Art. no.
left	88.000.000
right	88.001.000



The LISTA workstation system offers the right worktop for every application area, from the universal worktop with linoleum covering to the chrome steel worktop. Another plus point: If the support pillars for the superstructures are fastened behind the worktop, you can make effective use of the full worktop depth with the LISTA system.



### Multiplex top

- Made of steamed beech veneers, glued waterproof and with bevelled edges
- Sanded, oiled and waxed surface
- Versatile, splash-proof, dirt-repellent and largely impervious to oil and grease



### Beechwood top

- Made of steamed beech beams, glued waterproof and with bevelled edges
- Sanded, oiled and waxed surface
- Extremely resilient, splash-proof, dirt-repellent and largely impervious to oil and grease

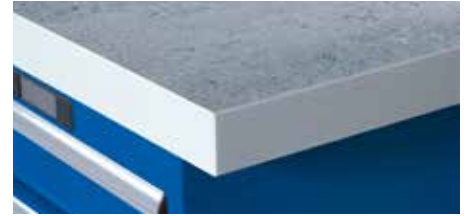

### Universal top

- Universal countertop for the workshop
- Linoleum covering, grey marbled, 2 mm, with ABS edges, light grey
- Impact-resistant and slightly dampening
- Limited scratch resistance
- Colour change due to darkness is a natural reaction (disappears in normal light conditions)
- Linoleum is made from natural raw materials



### Eterlux top

- For hygienic applications
- HPL coating, 3 mm, with ABS edges 2mm light grey
- Easy-to-clean surface texture
- Highest scratch resistance
- Heat-resistant up to 180°C, briefly up to 280°C
- Resistant to chemicals and solvents, also acids and alkalis to a certain extent
- Limited impact resistance



### Nitrile top

- Technical coating of natural rubber
- 4 mm rubber floor covering, with 2 mm black ABS edges
- Medium-hard, slip-resistant and shock-absorbing as well as oil and fuel-resistant
- Can be used at -10°C to +70°C
- Slight clouding or scratches are production-related and correspond to the normal surface condition of the product



### Metal coverings (on request)

- For high usage
- Very easy to clean and versatile
- Choice of sendzimir galvanised coating and chrome steel coating



### Resin top

- Colour light grey
- Easy-to-clean textured surface with HPL coating, 0.8 mm
- Resistant to common household chemicals, solvents, weak acids and alkalis
- High impact and scratch resistance
- Also available as an ESD model
- With ABS edges, 2 mm, grey



### ABS plate

- With hard, slightly grained surface texture, 2 mm
- With ABS edges, 2 mm, black
- High scratch resistance and impact resistance
- Resistant to chemicals, oils and greases

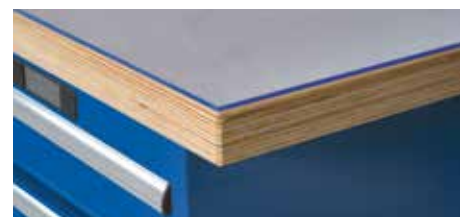

### PVC mat, 4 mm, transparent

- Dampening and slip-resistant
- Smooth, soft surface, easy to clean and impact-resistant
- Resistant to chemicals, solvents, weak acids and alkalis with brief exposure
- Do not use in combination with a beech top
- Made to measure (observe general cutting tolerances)
- PVC mat not suitable for beech wood top

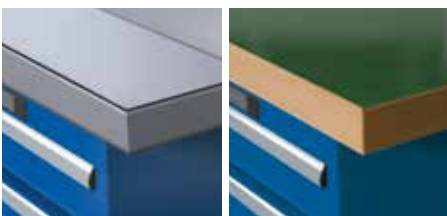

### Chrome steel and urphen plates

- Chrome steel plate sealed all round, ideal for pharmaceuticals and laboratories
- Available on request

Art. no.

Size max. 4000 × 1500

**39.574.000**



Pre-assembly version	for top thickness mm	Number of screws	Art. no.
For move workstation frame C design	30	9 × M6	<b>88.234.000</b>
For move workstation leg, H design	40–50	6 × M10	<b>88.232.000</b>
For move workstation frame, H design	30–50	12 × M8	<b>88.233.000</b>
For workbench leg assembly	40–50	6 × M10	<b>39.327.000</b>
For drawer cabinet	40–50	4 × M10	<b>39.161.000</b>

### Threaded inserts, pre-assembled

- For easy attachment of countertops to frame or leg

**i Note**  
All countertops are exclusively pre-assembly and fastening material

Features	Multiplex	Beech	Universal	Eterlux	Nitrile**	Metal coatings	Resin	ABS	PVC mat 4 mm
Impact/shock resistance	●	●	●	○	■	●		●	●
Scratch resistance			●	■	○	■	■	■	
Dampening			○		■				■
Cleaning / Hygiene			○	■		■	■	●	●
Heat resistance (soldering)				●		■	○		
Chemical resistance*			○	●	○	■	●	●	○
Acid resistance*			○	●	○	■	●	●	○
Alkali resistance*			○	●	○	■	●	●	○
Resistance to oil and grease*			●	●	●	■	●	●	●

\* incl. visual changes

■ applies above average ● applies ○ applies in part

\*\* Resistant to: good resistance to oil, good or limited resistance to fuel, not recommended for acids, alkalis or acetone. Changes to the surface and slight swelling of the surface caused by using chemicals, oils, soaps, etc. may occur; these are a material property and not a product defect. Excluding threaded inserts (pre-assembled) and fastening material. These must be ordered additionally depending on the sub-structure.

**!** The recommendations on resistance materials are general indicators and do not take into account secondary factors such as concentration of the agent, temperature, oxidation, etc. The information given is therefore not binding. Depending on the substances, preliminary clarifications are strongly recommended.

### Special and custom solutions on request

Special sizes m <sup>2</sup>	Thickness mm	max. size mm	Art. no.
<b>Multiplex</b>	30	2500 × 1250	<b>39.879.000</b>
	40	2500 × 1250	<b>39.344.000</b>
	50	2500 × 1250	<b>41.995.000</b>
<b>Beech</b>	40	3000 × 1200	<b>39.075.000</b>
	50	3000 × 1200	<b>39.020.000</b>
<b>Universal</b>	53	3000 × 1250	<b>39.572.000</b>
<b>Eterlux</b>	52	2750 × 1250	<b>39.573.000</b>
<b>Nitrile*</b>	43	3000 × 1000	<b>39.952.000</b>
	50	3000 × 1000	<b>39.956.000</b>
	23	2740 × 1200	<b>39.881.000</b>
<b>Resin</b>	30	2700 × 2000	<b>88.324.000</b>
	40	3000 × 1000	<b>39.085.000</b>
<b>ABS</b>	40	2000 × 1000	<b>42.519.000</b>

#### Customer-specific cut-outs and holes

- According to your specifications



\* Special size without edges. ABS edge black for nitrile plates 43 and 50 mm. Item no. **39.033.000**



## Multiplex

<b>W</b> →	Width mm	1000		
<b>D</b> ↗	Depth mm	700	800	1000

	Thickness mm	Art. no.	Art. no.	Art. no.
<b>Multiplex Standard</b>	30**	-	<b>88.252.000</b>	<b>88.253.000</b>
<b>Beech</b>	40	-	-	-
	50	-	-	-
with rear panel	40	-	-	-
	50	-	-	-
with steel edging protection at the front	40	-	-	-
	50	-	-	-
with chrome steel sheet coating****	40	-	-	-
	50	-	-	-
<b>Beech Standard</b>	40	-	-	-
	50	-	-	-
with rear panel	40	-	-	-
	50	-	-	-
with steel edging protection at the front	40	-	-	-
	50	-	-	-
<b>Universal</b>	53	-	-	-
<b>Eterlux</b>	52	-	-	-
<b>Nitrile</b>	43	-	-	-
	50	-	-	-
<b>Resin</b>	30**	-	<b>88.268.000</b>	<b>88.269.000</b>
	40	-	-	-

\* with Multiplex tops 3000 mm = 2 × 1500 mm glued

## Metal coverings

## Resin

## ABS see p. 125



## Side panels

The side panels are supplied screwed onto the worktop. Fastening material included. Specification: Multiplex, 150 mm high, thickness 20 mm, oiled.

For top thickness mm	Depth mm	Art. no.
<b>700</b>	720	<b>89.817.000</b>
<b>750</b>	770	<b>89.818.000</b>
<b>800</b>	820	<b>89.819.000</b>

1200				1500				
620	700	800	1000	620	700	750	800	1000
Art. no. <b>88.254.000</b>	Art. no. <b>88.255.000</b>	Art. no. <b>88.256.000</b>	Art. no. -	Art. no. <b>88.258.000</b>	Art. no. <b>88.259.000</b>	Art. no. -	Art. no. <b>88.260.000</b>	Art. no. <b>88.261.000</b>
-	-	-	-	-	<b>42.850.000</b>	<b>40.025.000</b>	<b>39.035.000</b>	-
-	-	-	-	-	<b>42.854.000</b>	<b>40.045.000</b>	<b>40.185.000</b>	-
-	-	-	-	-	<b>89.616.000</b>	<b>89.624.000</b>	<b>89.632.000</b>	-
-	-	-	-	-	<b>89.620.000</b>	<b>89.628.000</b>	<b>89.636.000</b>	-
-	-	-	-	-	<b>42.874.000</b>	<b>40.035.000</b>	<b>39.767.000</b>	-
-	-	-	-	-	<b>42.878.000</b>	<b>40.055.000</b>	<b>40.195.000</b>	-
-	-	-	-	-	<b>42.898.000</b>	<b>42.906.000</b>	<b>42.914.000</b>	-
-	-	-	-	-	<b>42.902.000</b>	<b>42.910.000</b>	<b>42.918.000</b>	-
-	-	-	-	-	<b>89.684.000</b>	<b>89.692.000</b>	<b>89.696.000</b>	-
-	-	-	-	-	<b>89.688.000</b>	<b>40.001.000</b>	<b>39.015.000</b>	-
-	-	-	-	-	<b>89.716.000</b>	<b>89.724.000</b>	<b>89.732.000</b>	-
-	-	-	-	-	<b>89.720.000</b>	<b>89.728.000</b>	<b>89.736.000</b>	-
-	-	-	-	-	<b>89.740.000</b>	<b>89.748.000</b>	<b>89.752.000</b>	-
-	-	-	-	-	<b>89.744.000</b>	<b>40.013.000</b>	<b>39.329.000</b>	-
-	-	-	-	-	-	<b>39.555.000</b>	<b>39.559.000</b>	-
-	-	-	-	-	-	<b>39.564.000</b>	<b>39.568.000</b>	-
-	-	-	-	-	-	<b>48.975.000</b>	<b>48.983.000</b>	-
-	-	-	-	-	-	<b>48.979.000</b>	<b>48.987.000</b>	-
<b>88.270.000</b>	<b>88.271.000</b>	<b>88.272.000</b>	-	<b>88.274.000</b>	<b>88.275.000</b>	-	<b>88.276.000</b>	<b>88.277.000</b>
-	-	-	-	-	-	<b>39.082.000</b>	<b>39.052.000</b>	-

\*\* Suitable for move C or H design, workstation frame

\*\*\* Chrome steel sheet coating 1.5 mm thick, bent down and screwed at the back, open on the sides, multiplex top is visible.

### Rear panels

The rear panels, which are supplied unattached, are screwed onto the worktop. Fastening material included. Specification: Multiplex, 150 mm high, thickness 20 mm, oiled.



### Shelves with raised sides

Specification: MDF worktop with 8 mm raised beech sides and back. Depth 300 mm, thickness 19 mm. Max. supported load 20 kg per linear metre. Colourless coating on all sides, without brackets (see below). Max. distance between supports 1100 mm.



For top thickness mm	Width mm	Art. no.
<b>1500</b>	1500	<b>89.812.000</b>
<b>2000</b>	2000	<b>89.813.000</b>
<b>2500</b>	2500	<b>89.814.000</b>
<b>3000</b>	3000*	<b>89.815.000</b>

For top thickness mm	required brackets	Art. no.
<b>1500</b>	2	<b>44.043.000</b>
<b>2000</b>	3	<b>44.044.000</b>
<b>2500</b>	3	<b>44.045.000</b>
<b>3000</b>	4	<b>44.046.000</b>

\* 2 × 1500 mm, adjoining edges



## Multiplex

	Thickness mm	Width mm		
		2000		
		620	700	750
<b>Multiplex Standard</b>	30**	88.262.000	88.263.000	-
<b>Beech</b>	40	-	42.851.000	40.027.000
	50	-	42.855.000	40.047.000
with rear panel	40	-	89.617.000	89.625.000
	50	-	89.621.000	89.629.000
with steel edging protection at the front	40	-	42.875.000	40.037.000
	50	-	42.879.000	40.057.000
with chrome steel sheet coating****	40	-	42.899.000	42.907.000
	50	-	42.903.000	42.911.000
<b>Beech Standard</b>	40	-	89.685.000	89.693.000
	50	-	89.689.000	40.003.000
with rear panel	40	-	89.717.000	89.725.000
	50	-	89.721.000	89.729.000
with steel edging protection at the front	40	-	89.741.000	89.749.000
	50	-	89.745.000	40.015.000
<b>Universal</b>	53	-	-	39.556.000
<b>Eterlux</b>	52	-	-	39.565.000
<b>Nitrile</b>	43	-	-	48.976.000
	50	-	-	48.980.000
<b>Resin</b>	30**	88.278.000	88.279.000	-
	40	-	-	39.083.000

\* with Multiplex tops 3000 mm = 2 x 1500 mm glued

## Metal coverings

## Resin

## ABS see p. 125



### Brackets, height-adjustable

Enable the shelves with raised sides to be adjusted to four different heights. Adjustment height relative to worktop 230, 270, 310 and 350 mm. They are fixed in place through the workbench top (pre-assembly required). Including fastening material. Specification: made from steel box section, including fastening material for each unit. Colour: light grey, RAL 7035.

Description	Depth mm	Art. no.
<b>Brackets</b> , height-adjustable	280	<b>44.047.000</b>
<b>Pre-assembly</b> per bracket (please specify position)	-	<b>39.208.000</b>



2000		2500			3000*		
800	1000	700	750	800	700	750	800
Art. no.	Art. no.	Art. no.	Art. no.	Art. no.	Art. no.	Art. no.	Art. no.
88.264.000	88.265.000	-	-	-	-	-	-
39.037.000	-	42.852.000	40.028.000	39.039.000	42.853.000	42.858.000	42.860.000
40.187.000	-	42.856.000	40.048.000	40.188.000	42.857.000	42.859.000	42.861.000
89.633.000	-	89.618.000	89.626.000	89.634.000	89.619.000	89.627.000	89.635.000
89.637.000	-	89.622.000	89.630.000	89.638.000	89.623.000	89.631.000	89.639.000
39.768.000	-	42.876.000	40.038.000	39.769.000	42.877.000	42.882.000	42.884.000
40.197.000	-	42.880.000	42.058.000	40.198.000	42.881.000	42.883.000	42.885.000
42.915.000	-	42.900.000	42.908.000	42.916.000	42.901.000	42.909.000	42.917.000
42.919.000	-	42.904.000	42.912.000	42.920.000	42.905.000	42.913.000	42.921.000
89.697.000	-	89.686.000	89.694.000	89.698.000	89.687.000	89.695.000	89.699.000
39.017.000	-	89.690.000	40.004.000	39.018.000	89.691.000	40.005.000	39.019.000
89.733.000	-	89.718.000	89.726.000	89.734.000	89.719.000	89.727.000	89.735.000
89.737.000	-	89.722.000	89.730.000	89.738.000	89.723.000	89.731.000	89.739.000
89.753.000	-	89.742.000	89.750.000	89.754.000	89.743.000	89.751.000	89.755.000
39.331.000	-	89.746.000	40.016.000	39.332.000	89.747.000	40.017.000	39.333.000
39.560.000	-	-	39.557.000	39.561.000	-	39.558.000	39.562.000
39.569.000	-	-	39.566.000	39.570.000	-	-	-
48.984.000	-	-	48.977.000	48.985.000	-	48.978.000	48.986.000
48.988.000	-	-	48.981.000	48.989.000	-	48.982.000	48.990.000
88.280.000	88.281.000	-	-	-	-	-	-
39.076.000	-	-	39.134.000	39.135.000	-	39.084.000	39.086.000

\*\* Suitable for move C or H design, workstation frame

\*\*\* Chrome steel sheet coating 1.5 mm thick, bent down and screwed at the back, open on the sides, multiplex top is visible.



### Stop buffer

Stop buffer prevents the mobile drawer cabinet from rolling too deep under the table. The stop buffer is attached to the underside of the countertop (thickness > 40 mm) with wood screws. Designed for mobile drawer cabinet H: 890 in combination with stationary drawer cabinet H: 850 mm and levelling feet +50 mm

Width mm	Height mm	Art. no.
620	155	69.965.XXX



### Support crossbar

By stabilising the countertop using a support crossbar, large spans of up to 2500 mm can be achieved without the use of a third workbench leg assembly. This support crossbar can also be retrofitted to the workbench leg assemblies.

for top width mm	for top depth mm	Load capacity kg	Art. no.
2000	800	500	89.155.XXX
2500	800	500	89.156.XXX





## Dimensions

### Distances between supports with 2 or 3 workbench leg assemblies, with or without storage shelf

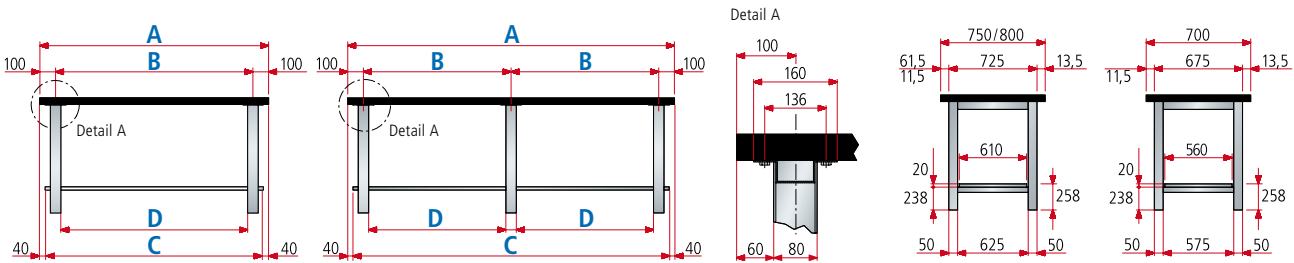

Worktop width mm	Number of leg assemblies	Multiplex		Beech		Universal	Eterlux	Nitrile		Resin	ABS	Width between supports mm	Storage shelf mm	Clear width mm	
		40 mm	50 mm	40 mm	50 mm	53 mm	52 mm	43 mm	50 mm	40 mm	40 mm				
<b>W</b>		<b>A</b>											<b>B</b>	<b>C</b>	<b>D</b>
1500	2	●	●	●	●	●	●	●	●	●	●	1300	1420	1220	
2000	2	●	●	●	●	●**	●**	●	●	●**	●**	1800	1920	1720	
2000	3	●	●	●	●	●	●	●	●	●	●	900	1920	820	
2500	2	●**	●	●**	●	●**	●**	●**	●	●**	●**	2300	2420	2220	
2500	3	●	●	●	●	●	●	●	●	●	●	1150	2420	1070	
3000*	3	●	●	●	●	●	●	●	●	●	●	1400	2 × 1460	1320	

### Distances between supports with workbench leg assembly and drawer cabinet 27 × 27 E or 27 × 36 E, with or without storage shelf

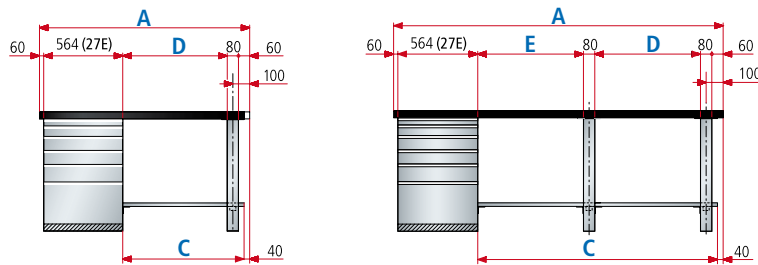

18 × 27 E	<b>27 × 27 E</b>	36 × 27 E
18 × 36 E	<b>27 × 36 E</b>	36 × 36 E

**Note**  
 Workbenches are also available with drawer cabinets in sizes:  
 18 × 27 E = 306 × 459 mm (W × D)  
 27 × 27 E = 459 × 459 mm (W × D)  
 36 × 27 E = 612 × 459 mm (W × D)  
 18 × 36 E = 306 × 612 mm (W × D)  
 27 × 36 E = 459 × 612 mm (W × D)  
 36 × 36 E = 612 × 612 mm (W × D)

Worktop width mm	Number of leg assemblies	Multiplex		Beech		Universal	Eterlux	Nitrile		Resin	ABS	Storage shelf mm	Clear width mm	Clear width mm	
		40 mm	50 mm	40 mm	50 mm	53 mm	52 mm	43 mm	50 mm	40 mm	40 mm				
<b>W</b>		<b>A</b>											<b>C</b>	<b>D</b>	<b>E</b>
1500	1	●	●	●	●	●	●	●	●	●	●	835	736	-	
2000	1	●	●	●	●	●	●	●	●	●	●	1335	1236	-	
2500	1	●	●	●	●	●	●	●	●	●	●	1835	1736	-	
2500	2	-	-	-	-	-	-	-	-	●**	●**	1835	1070	586	
3000*	2	●	●	●	●	●	●	●	●	●	●	2335	1320	836	

\* Multiplex 2 × 1500 mm glued.

\*\* When using the support crossbar, see page 129

● possible

- not possible



## Loads

### Workbench tops

Max surface loads of the tops. These specifications apply with evenly distributed loads and static applications.

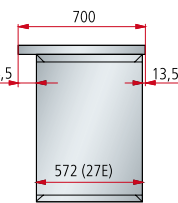
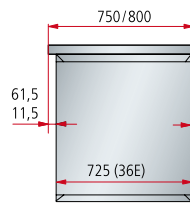
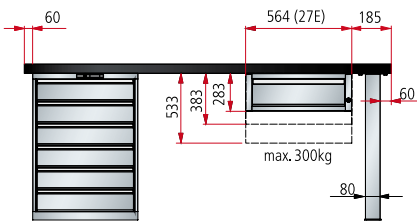

» Desk chairs  
see p. 164–167

» Superstructures and  
accessories see p. 132

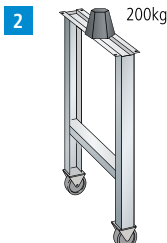
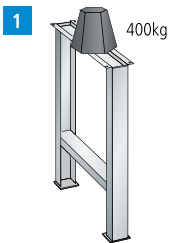

**1** The maximum load is 400 kg for the fixed workbench leg assembly and 200 kg for the workbench leg assembly with castors with evenly distributed loads and static applications.

**2** For this version, the load specifications (see tables below) must be halved in each case.

### Loads with workbench legs or a combination of workbench legs and drawer cabinet



	Top thickness mm	Worktop width mm			Worktop width mm			Worktop width mm			Worktop width mm	
		1500	2000	2500	2000	2500	3000	1500	2000	2500	2500	3000
<b>Multiplex</b>	40	600 kg	360 kg	500 kg*	1200 kg	1050 kg	650 kg	1500 kg	800 kg	360 kg	3000 kg	1600 kg
<b>Multiplex</b>	50	800 kg	500 kg	400 kg	1200 kg	1200 kg	1200 kg	1500 kg	1000 kg	500 kg	3000 kg	2000 kg
<b>Beech</b>	40	600 kg	360 kg	500 kg*	1200 kg	1050 kg	650 kg	1500 kg	800 kg	360 kg	3000 kg	1600 kg
<b>Beech</b>	50	800 kg	500 kg	400 kg	1200 kg	1200 kg	1200 kg	1500 kg	1000 kg	500 kg	3000 kg	2000 kg
<b>Universal</b>	53	700 kg	350 kg	500 kg*	900 kg	700 kg	450 kg	1100 kg	700 kg	350 kg	3000 kg	1400 kg
<b>Eterlux</b>	52	700 kg	350 kg	500 kg*	900 kg	700 kg	450 kg	1100 kg	700 kg	350 kg	3000 kg	1400 kg
<b>Nitrile</b>	43	500 kg	320 kg	500 kg*	800 kg	680 kg	360 kg	700 kg	310 kg	320 kg	1800 kg	1100 kg
<b>Nitrile</b>	50	800 kg	450 kg	300 kg	1200 kg	1200 kg	720 kg	1300 kg	600 kg	300 kg	3000 kg	1400 kg
<b>Resin</b>	40	350 kg	500 kg*	500 kg*	650 kg	400 kg	300 kg	650 kg	350 kg	500 kg*	1100 kg	700 kg
<b>ABS</b>	40	350 kg	500 kg*	500 kg*	650 kg	400 kg	300 kg	650 kg	350 kg	500 kg*	1100 kg	700 kg

\* When using a support beam, see p. 129

## Overview of universal superstructures

**With our universal superstructures, you can design each workstation ergonomically, neatly and individually.** The consistent and form-fitting design ensures an attractive appearance and enables virtually invisible cable routing. All superstructures are easy to install and also available as an ESD model.



- Cantilever, single, double sided**
- Integrated and interlocking design for almost invisible cabling.

see page 139



- Rear panels**
- Perforated or smooth
  - For attaching tool holders
  - Smooth rear panels can also be mounted on the back for a complete room partition

see page 140/141

- Support pillars**
- Flexibly mountable
  - Vertically adjustable in increments of 50 mm
  - Continuously adjustable horizontally for flexible attachment to any substructure

see page 138/139

- Rear power panel**
- For accommodating power modules and elements
  - Fully integrated into the rear panel
  - Simple assembly and dismantling

see page 144



- Cable trough (visualisation: sectional view)**
- Fastening to the rear side of support pillars
  - Optimum cable routing and protection
  - Suitable for linked solutions

see page 144

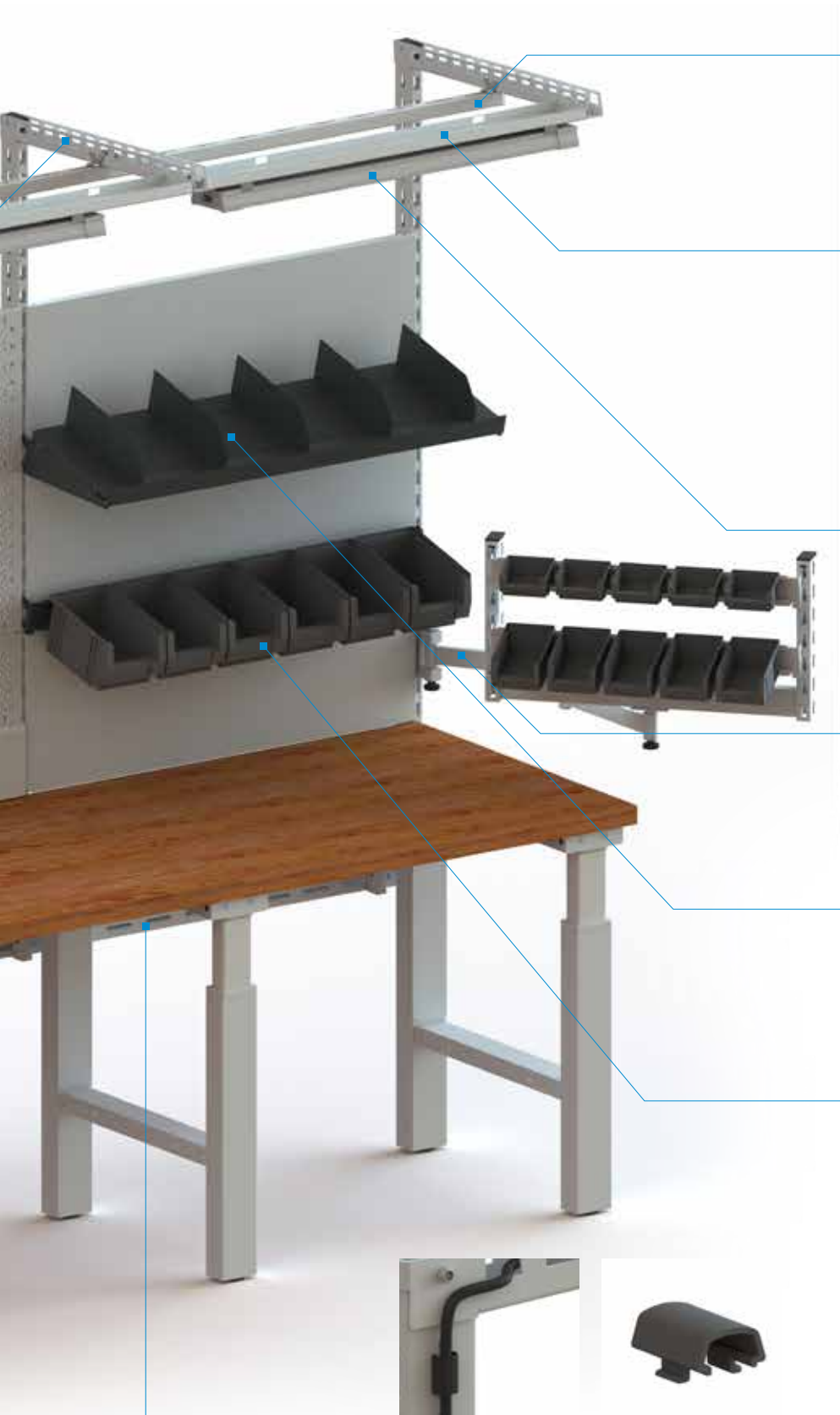

**Equipment rail**

- For use with carriages
- Fast and easy assembly
- Linking possible via multiple workstations

see page 139



**Integrated lighting carrier**

- For accommodating lighting and cabling.
- Interlocking design for almost invisible cabling

see page 139

**Lighting**

- Wide selection of different LED lights

see page 146

**Swivel arm**

- For mounting on support pillar
- One or two arms
- For holding peripheral devices and accessories

see page 140

**Adjustable shelf**

- Load capacity up to 50 kg
- Can be attached horizontally or tilted at an angle of up to 15 degrees
- Can be attached largely without tools

see page 140/141

**Container strips**

- For holding storage containers
- Can be attached horizontally or at an angle of 15 degrees
- Can be attached largely without tools

see page 140/141

**Guide rail**

- For fastening and horizontal positioning of support pillars

see page 138



**Cable routing clip**

- Enables clean cable routing, easy installation and removal
- Suitable for support pillars and perforated rear panels

see page 144



**ESD**

- ESD protected version available as an option

see page 24–27

### Superstructures on the workbench substructure for move H design or workbenches

#### Support pillars on the workbench substructure

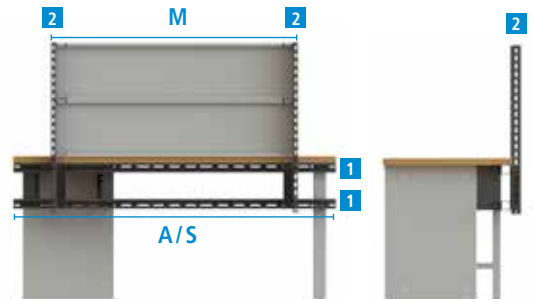

load capacity of up to 150 kg

- 1 Guide rail pair
- 2 Support pillar



#### Module width of superstructures mm

Top width mm	Support rail pair width mm	Module width of superstructures mm							Number of support pillars with standard
		665	750	1000	1330	1500	2000	Standard	
A	S	M						2	
1000	1000	●	●	●	-	-	-	1×1000	2
1500	1500	●	●	●	●	●	-	1×1500	2
2000	2000	●	●	●	●	●	●	1×2000	2
2500	2500	●	●	●	●	●	●	1×1500, 1×1000	3
3000	3000	●	●	●	●	●	●	2×1500	3

● possible    - not possible

### Use of TWIN link adapters for drawer cabinet depth 27 E

Different adapter plates (TWIN links) are required to enable different configuration options between countertop depths and drawers with cabinet depths of 27E. Generally, a TWIN link does not need to be used when **using a drawer cabinet with a depth of 36 E**. The use of the cover profile may be necessary when using a 700 or 750 mm deep countertop, see p. 138.



Countertop Depth mm	Cabinet / Cabinet				Cabinet / Workbench leg assembly				Workbench leg assembly / Workbench leg assembly			
	Cabinet Depth E	Cabinet Depth E	TWIN link	Cover profile**	Cabinet Depth E	Leg Depth mm	TWIN link*	Cover profile**	Leg Depth mm	Leg Depth mm	TWIN link*	Cover profile**
700	27	27	A	-	27	675	B	yes	675	675	-	yes
750	27	27	B	-	27	675	B	-	675	675	-	-
	36	36	-	yes	36	725	-	yes	675	675	-	-
800	27	27	C	-	27	725	C	-	725	725	-	-
	36	36	-	-	36	725	-	-	725	725	-	-

\* TWIN link is not required for workbench leg assembly

\*\* + 50 mm

## Configuration of support pillars and rear panels

Rear panels optional  
(as room divider or for rear use)

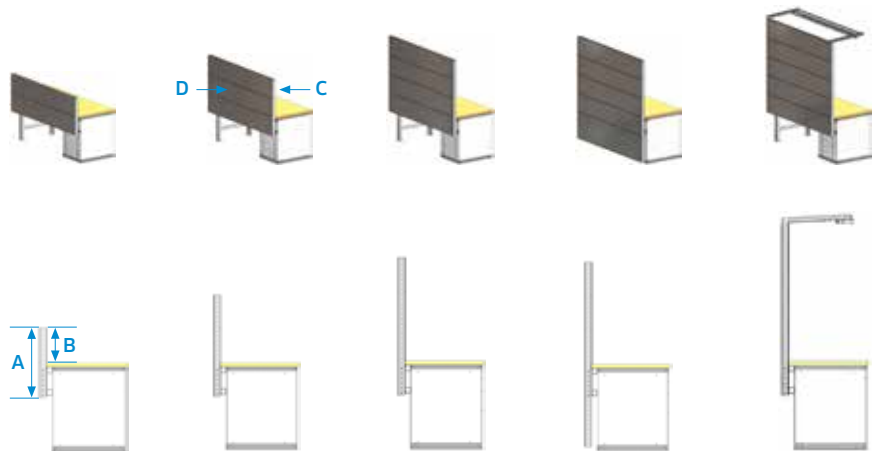

		700	1050	1400	1900	1800
<b>A</b>	<b>Support pillar height</b>	700	1050	1400	1900	1800
<b>B</b>	<b>Usable height</b>	350	700	1050	1050	1400
<b>C</b>	<b>Number of rear panels at front</b>	350*	1	2	3	3
		350**	2	3	4	4
<b>D</b>	<b>Number of rear panels at rear</b>	500	-	-	1	-

\* Alternative variant: Power conduit cover plate 150 mm (see p. 144) with a rear panel 200 mm (see p. 140/141)

\*\* Alternative variant: Cable tray (see p. 144)



### Superstructures on workbench substructure for workstation frame, C design



#### Module widths of workstation frame, C design

Support pillars generally on the substructure, load capacity up to 150 kg

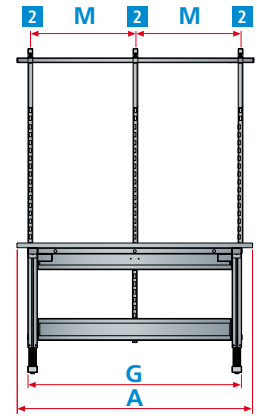
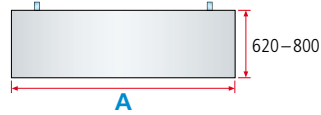

Worktop width mm	Frame width mm	Module width of superstructures mm							Max. installation width for superstructures	Standard	Number of support pillars with standard
		665	750	1000	1330	1500	2000	Standard			
A	G	M									2
1200	1030	●	●	●	-	-	-	1000	1 × 665	2	
1500	1360	●	●	●	●	-	-	1330	1 × 1330	2	
2000	1780	●	●	●	●	●	-	1665	1 × 665, 1 × 1000	3	

● possible - not possible

### Superstructures on workbench tops for H design, workbenches, compact and system workbenches



#### Superstructures with support pillars on worktop<sup>1</sup>

load capacity up to 100 kg

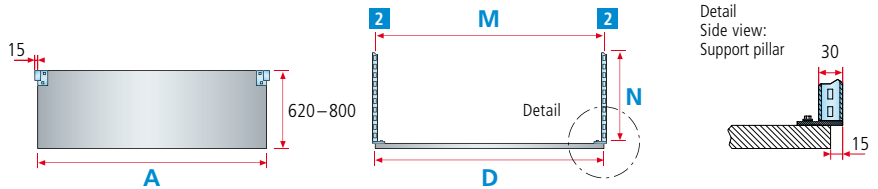

Worktop width mm	Module width of superstructures mm							Standard	Number of support pillars with standard
	665	750	1000	1330	1500	2000	Standard		
A	M								2
1000*	●	●	●	-	-	-	1 × 1000	2	
1250**	●	●	●	-	-	-	1 × 1000	2	
1500	●	●	●	●	●	-	1 × 1500	2	
2000	●	●	●	●	●	●	1 × 2000	2	
2500	●	●	●	●	●	●	1 × 1500, 1 × 1000	3	
3000	●	●	●	●	●	●	2 × 1500	3	

\* Worktop width available only for compact workbenches.

\*\* Worktop width available only for system workbenches.

<sup>1</sup> Only suitable for mounting on workbench tops made from beechwood and Multiplex.

● possible - not possible



Nom. width mm	350	700	1050	1400***
Pillar height mm	350	700	1050	1400
N				

Workbench	●	●	●	●
Compact workbench	●	●	●	●
System workbench	●	●	●	●

\*\*\* must be stabilised by supporting bracket.





**i** The preconfigured workstations only consist of the superstructure. Simple expansion and rearrangement to suit specific requirements. The substructures (legs or frame) must be ordered separately.

Lighting must be ordered separately, see page 146



**Universal superstructures for workbench leg assemblies**

Equipment	for top width mm	Module width mm	Type	H mm	Art. no.
2 support pillars for mounting on workbench top	1500	1500	-	700*	<b>89.070.XXX</b>
2 perforated rear panels	2000	2000	-	700*	<b>89.071.XXX</b>



2 support pillars for mounting on workbench top including left and right support brackets	1500	1500	DE/PE	1460*	<b>89.072.XXX</b>
2 brackets for support pillars	2000	2000	DE/PE	1460*	<b>89.073.XXX</b>
2 brackets for support pillars	1500	1500	CH**	1460*	<b>89.062.XXX</b>
1 equipment rail including 2 suspension sets	2000	2000	CH**	1460*	<b>89.063.XXX</b>
1 carriage	1500	1500	F	1460*	<b>89.064.XXX</b>
1 perforated rear panel	1500	1500	F	1460*	<b>89.065.XXX</b>
1 adjustable shelf, plain, depth 350 mm	2000	2000	F	1460*	<b>89.065.XXX</b>
1 power rear panel preconfigured, mounting on support pillar, with 1 switch and 5 sockets 230 V, including connecting cable	1500	1500	GB	1460*	<b>89.066.XXX</b>
	2000	2000	GB	1460*	<b>89.067.XXX</b>

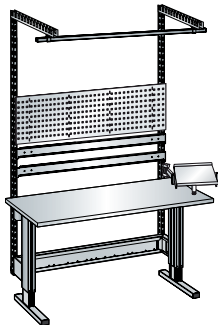

**Universal superstructures for workstation frame, C design**

2 support pillars					
2 brackets for support pillars					
1 equipment rail including 2 suspension sets					
1 carriage					
1 perforated rear panel					
2 container strips					
1 swivel arm fixing device					
1 double joint swivel arm					
1 swivelling shelf	1500	1330	-	1210*	<b>89.074.XXX</b>

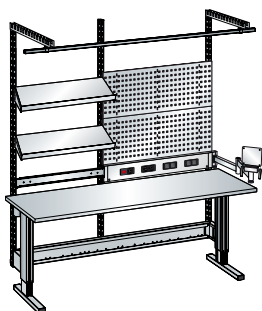

3 support pillars					
2 brackets for support pillars					
1 equipment rail including 2 suspension sets					
1 carriage					
2 perforated rear panels					
1 container strip					
2 adjustable shelves, plain, depth 350 mm					
1 swivel arm fixing device	2000	1000/665	DE/PE	1210*	<b>89.075.XXX</b>
1 double joint swivel arm	2000	1000/665	CH***	1210*	<b>89.076.XXX</b>
1 TFT monitor mount	2000	1000/665	F	1210*	<b>89.077.XXX</b>
1 rear power panel preconfigured, mounting on support pillar, with 1 switch and 3 sockets 230 V, including connecting cable	2000	1000/665	GB	1210*	<b>89.078.XXX</b>



\* Height from upper edge of table top mm

\*\* Type CH: 1 switch with 1 thermal fuse and 4 socket outlets 230 V

\*\*\* Type CH: 1 switch with 1 thermal fuse and 2 socket outlets 230 V

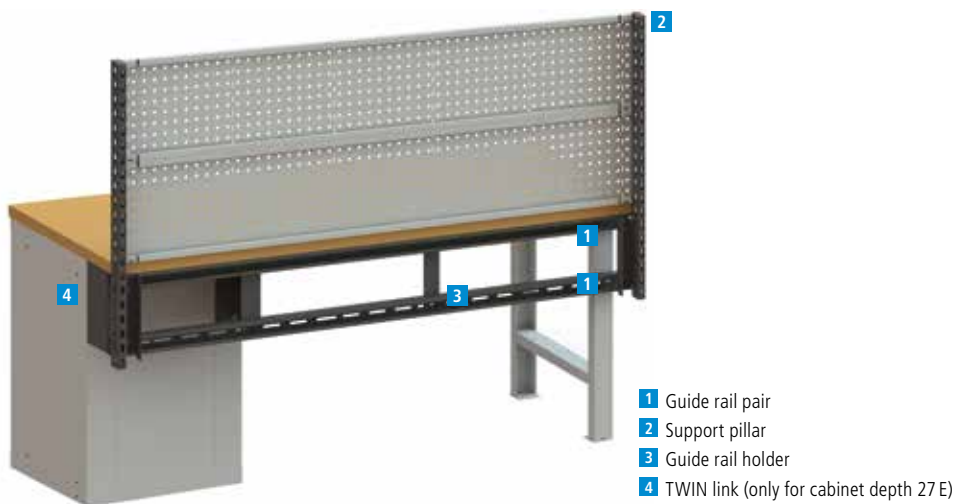

- 1 Guide rail pair
- 2 Support pillar
- 3 Guide rail holder
- 4 TWIN link (only for cabinet depth 27 E)



#### Module width of superstructures

The module width refers to the axis dimension of the superstructures (measured from the centres of the support pillars). The number and dimensions of the modules used may vary depending on the frame and top width. We will be happy to advise you.

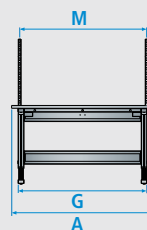

- M Module width
- G Frame width
- A Top width

#### Guide rail pair for fitting to the workbench substructure\*

The guide rail pair is available in 5 widths and is designed for the H leg, workbench leg assembly and for the drawer cabinet. Incl. fastening material. Model: Sheet steel, colour as per colour chart.



W → mm

W → mm	Art. no.
1000	89.140.XXX
1500	89.141.XXX
2000	89.142.XXX
2500	89.143.XXX
3000	89.144.XXX

\* Se si utilizza l'armadio a cassettei T: 27 E è necessario un adattatore TWIN-Link.

#### Support pillar for mounting on workbench substructure

Scope of delivery: 1 unit

To guide rail pair for

#### Workbench leg assembly move workstation leg, H design move workstation frame, H design

The support pillars are available in 5 heights. Capacity 150 kg. A guide rail pair is required for fitting. Incl. pillar bracket and fastening material. Model: Steel profile, perforated on four sides in increments of 50 mm for attaching the superstructure components with limited use of screws. For double workstations, the same support pillars are used for both sides. Colour: as per colour chart.



H ↑ mm	Usable height mm	Art. no.
700	350	89.225.XXX
1050	700	89.226.XXX
1400	1050	89.227.XXX
1800	1400	89.228.XXX
1900	1050	89.229.XXX

#### Guide rail holder

To further stabilize the guide rail pair, this rail holder can be used, which is attached to the underside of the countertop. Model: Sheet steel, colour: as per colour chart.



W → × D ↗ × H ↑ mm

W → × D ↗ × H ↑ mm	Art. no.
60 × 272 × 272	89.130.XXX

#### TWIN link adapter

Different adapter plates (TWIN links) are necessary to enable different configuration options between countertop depths and drawer cabinet depths of 27 E. The required TWIN link size can be found in the matrix on page 134. Model: sheet steel. Colour: as per colour chart.



Type	D ↗ mm	Art. no.
A	52.5	89.149.XXX
B	102.5	89.147.XXX
C	152.5	89.148.XXX

#### move workstation frame, C design

The support pillars are available in two different heights and are mounted onto the cross-bars of the frame using the fastening material provided. Capacity 150 kg. Model: Steel profile, perforated on four sides in increments of 50 mm for attaching the superstructure components with limited use of screws. For double workstations, the same support pillars are used for both sides. Colour: as per colour chart.

H ↑ mm	Usable height mm	Art. no.
1000	350	65.128.XXX
1700	1050 / 1150	65.129.XXX

#### Cover profiles for workbench

Matching cover profiles fill the gap between the countertop and support pillar for workbenches (planning information, see page 134), including fastening material. Description: sheet steel. Colour: according to colour chart.



W → mm	D ↗ mm	for top thickness mm	Art. no.
1500	50	40/50	89.330.XXX
2000	50	40/50	89.333.XXX
2500	50	40/50	89.336.XXX

### Support pillars for mounting onto countertops

The support pillars are available in four different heights and must be screwed directly onto the top surface on site using the fastening material provided. Capacity 100 kg. Model: Steel profile, perforated on four sides in increments of 50 mm for attaching the superstructure components with minimum use of screws. Colour: as per colour chart. Only suitable for mounting on countertops made from beechwood and multiplex. Plate thickness min. 40 mm. Mounting options on other countertops on request.

Pillar height mm	Left	Centre	Right
350	<b>89.423.XXX</b>	<b>89.420.XXX</b>	<b>89.424.XXX</b>
500	<b>343.328.XXX</b>	<b>344.108.XXX</b>	<b>343.327.XXX</b>
700	<b>89.425.XXX</b>	<b>89.421.XXX</b>	<b>89.426.XXX</b>
1050	<b>89.952.XXX</b>	<b>89.954.XXX</b>	<b>89.953.XXX</b>
1400*	<b>89.427.XXX</b>	<b>89.422.XXX</b>	<b>89.428.XXX</b>

\* When loaded to capacity, a support bracket is mandatory (see below).



### Support bracket

To provide additional stability for the support pillars on the countertop. Mandatory from pillar heights of 1400 mm. Model: Sheet steel. Colour: as per colour chart.

	Art. no.
Left	<b>89.433.XXX</b>
Right	<b>89.434.XXX</b>



### Support pillars for wall mounting

For mounting rear panels, adjustable shelves and container strips directly to the wall. Fastening material included. Specification: Steel U-profile, increments of 50 mm, sinkhole for wall mounting every 200 mm on concrete wall (nylon wall plugs No. 8 and countersunk screw 5 x 70). Colour: as per colour chart. Swivel shelves cannot be attached to wall-mounted rails.

H  mm	Width mm	Depth mm	Art. no.
<b>350</b>	30	40	<b>89.435.XXX</b>
<b>700</b>	30	40	<b>89.436.XXX</b>
<b>1050</b>	30	40	<b>89.437.XXX</b>



### Cantilever

The cantilever is fastened to the support pillar and serves to hold the equipment rail and the lighting carrier. In addition, the cantilever ensures clean and almost invisible cable routing as a cable conduit. The double-sided version is used for double workstations. Incl. fastening material. Load capacity 15 kg. Model: sheet steel. Colour: as per colour chart.

	Art. no.
Simple	<b>89.232.XXX</b>
Double-sided	<b>89.233.XXX</b>



### Equipment rail

For supporting the carriage. The equipment rail is attached directly to the cantilever and can be individually adjusted in depth. Load capacity 15 kg. (Delivery excluding carriage: **89.452.000**). Sheet steel version. Colour: as per colour chart.

Width mm	Art. no.
665	<b>89.240.XXX</b>
750	<b>89.241.XXX</b>
1000	<b>89.242.XXX</b>
1330	<b>89.244.XXX</b>
1500	<b>89.245.XXX</b>
2000	<b>89.246.XXX</b>
2500	<b>89.247.XXX</b>

### Lighting support

The lighting carrier is mounted directly on the cantilever without tools and can be individually adjusted in depth. It serves to hold LISTA lighting (see page 146) and ensures clean and almost invisible cable routing. Module widths 1665 mm (**89.001.XXX**) and 1750 mm (**89.000.XXX**) are also available for special configuration purposes. Model: Sheet steel, colour: as per colour chart.

Module width mm	Art. no.
665	<b>89.234.XXX</b>
750	<b>89.235.XXX</b>
1000	<b>89.236.XXX</b>
1330	<b>89.237.XXX</b>
1500	<b>89.238.XXX</b>
2000	<b>89.239.XXX</b>



### Perforated rear plain or panels

The support pillars can be vertically fitted with rear panels, either partially or up to their full height. All rear panels can be attached to the support pillars without screws. Rear panels perforated with square holes 10 × 10 mm, 38 mm division and slots 380 mm apart for accommodating storage shelves and can holders (see p. 141). Specification: sheet steel. Colour: as per colour chart.

### Container strips

To hold size 2, 3 and 4 storage containers; can be attached to the support pillars without screws. Max. load capacity 15 kg. Specification: sheet steel. Colour: as per colour chart.

### Adjustable shelves, plain or slotted

The adjustable shelves are fitted with a stop bar on one of their longitudinal sides. The adjustable shelves can be attached with the stop bar on either the front or the rear. For adjustable shelves, slotted: slots 15 mm apart for partitioning with dividers. Using two brackets, the adjustable shelves are attached to the support pillars without screws, either horizontally or with an inclination angle of 15°. Load capacity 50 kg. Normal level 25 mm + 17 mm stop bar. Including two brackets each. Specification: sheet steel. Colour: as per colour chart.

### Swivel arm attachments

For accommodating the swivel arm elements directly on the table frame (individual workstation) or on the support pillar. Table frame holder galvanised. Specification: steel. Colour: light grey, RAL 7035.

Fixing to	Width mm	Height mm	Depth mm	kg	Art. no.
<b>Table frame</b>	30	280	30	25	<b>65.244.000</b>
<b>Support pillar</b>	30	105	123	25	<b>65.346.000</b>

### Swivel arm

Double-jointed swivel arms with 1 axis and 1 swivel arm add-on. The swivel arm add-ons are fitted with internal slide bearings. The swivel radius is 300 mm. Specification: steel. Colour: light grey, RAL 7035. Without swivel arm fixing device.

Specification	Length mm	kg	Art. no.
<b>Double-jointed swivel arm</b>	2 × 300	25	<b>65.347.000</b>

### Module frames for swivel arm

Welded steel tube frame with perforations on four sides. Perforations at 50 mm increments, with steel axis for fixing onto the swivel arm. Load capacity 25 kg. Specification: sheet steel. Colour: light grey, RAL 7035.

Version with	Width mm	Height mm	Depth mm	Art. no.
<b>1 rear panel</b>	665	350	65	<b>65.350.000</b>
<b>2 adjustable shelves*</b>	665	350	265	<b>65.351.000</b>
<b>2 swivel shelves</b>	665	350	424	<b>65.353.000</b>
<b>3 container strips</b>	665	350	90	<b>65.352.000</b>

\* Depth of adjustable shelf 200 mm.

### Swivel shelves for swivel arm

Swivel shelves for swivel arm, with steel axis for fixing onto the swivel arm add-on, with stop bar on both sides. Tilt angle can be infinitely adjusted by up to 30°. Specification: sheet steel. Colour: light grey, RAL 7035.

Width mm	Depth mm	Height mm	kg	Art. no.
<b>300</b>	426	72	25	<b>65.354.000</b>

for module width mm **665**

**W** → Usable width mm 655

**H** ↑ Specification Art. no. 

**200 plain** **89.031.XXX**

**350 plain** **89.043.XXX**

**500 plain** **89.049.XXX**

**200 perforated** **89.025.XXX**

**350 perforated** **89.037.XXX**

**500 perforated** **89.113.XXX**

**W** → Usable width mm 660

**H** ↑ Specification Art. no. 

**85** **65.234.XXX**

Container size 2 3 4

Number of containers 6–12 6 4

**W** → Usable width mm 664

**D** ↗ Specification Art. no. 

**200 plain** **65.257.XXX**

**300 plain** **65.258.XXX**

**350 plain** **89.845.XXX**

**400 plain** **65.260.XXX**

**200 slotted** -

**300 slotted** **89.822.XXX**

**350 slotted** **89.828.XXX**

**400 slotted** **89.834.XXX**

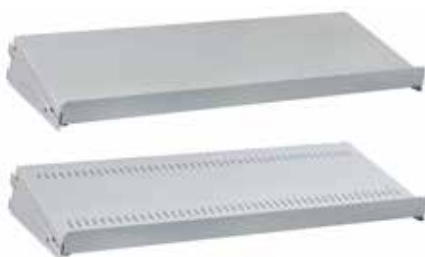
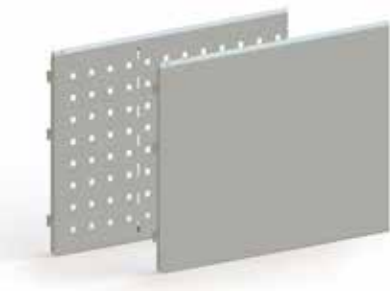

750			1000			1330			1500			2000		
740			990			1320			1490			1990		
Art. no.			Art. no.			Art. no.			Art. no.			Art. no.		
89.032.XXX			89.033.XXX			89.034.XXX			89.035.XXX			89.036.XXX		
89.044.XXX			89.045.XXX			89.046.XXX			89.047.XXX			89.048.XXX		
89.050.XXX			89.051.XXX			89.052.XXX			89.053.XXX			89.054.XXX		
89.026.XXX			89.027.XXX			89.028.XXX			89.029.XXX			89.030.XXX		
89.038.XXX			89.039.XXX			89.040.XXX			89.041.XXX			89.042.XXX		
89.114.XXX			89.115.XXX			89.116.XXX			89.117.XXX			89.118.XXX		
745			995			1325			1495			1995		
Art. no.			Art. no.			Art. no.			Art. no.			Art. no.		
89.460.XXX			65.085.XXX			65.235.XXX			89.461.XXX			89.462.XXX		
2	3	4	2	3	4	2	3	4	2	3	4	2	3	4
7-14	7	5	9-18	9	6	12-24	12	8	14-28	14	10	19-38	19	13
749			999			1329			1499			1999		
Art. no.			Art. no.			Art. no.			Art. no.			Art. no.		
89.840.XXX			65.261.XXX			65.263.XXX			89.841.XXX			89.842.XXX		
89.901.XXX			65.132.XXX			65.264.XXX			89.843.XXX			89.844.XXX		
89.902.XXX			89.903.XXX			89.846.XXX			89.847.XXX			89.848.XXX		
89.849.XXX			65.262.XXX			65.266.XXX			89.850.XXX			89.851.XXX		
-			-			-			-			-		
89.823.XXX			89.824.XXX			89.825.XXX			89.826.XXX			89.827.XXX		
89.829.XXX			89.830.XXX			89.831.XXX			89.832.XXX			89.833.XXX		
89.835.XXX			89.836.XXX			89.837.XXX			89.838.XXX			89.839.XXX		

» For keyhole hooks and storage containers see p. 162/163

### Add-ons for perforated rear panels

Can be hooked into the slots on the rear panels. Storage shelf with stop bar at the front, 15 mm. Colour: black, NCS S 9000-N.

Specification	Width mm	Depth mm	Height mm	Art. no.
<b>Additional rack</b>	380	310	70	<b>81.081.000</b>
<b>Spray can holder</b>	380	74	70	<b>81.083.000</b>

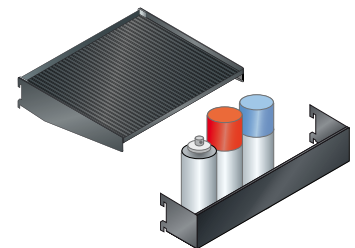

### Dividers

For subdividing slotted adjustable shelves. Specification: sheet steel. Colour: as per colour chart. Sales unit: 10 pcs.

Depth mm	Height mm	Art. no.
300	100	50.103.XXX
300	150	50.104.XXX
300	200	50.105.XXX
350	100	50.106.XXX
350	150	50.107.XXX
350	200	50.108.XXX
400	100	50.109.XXX
400	150	50.110.XXX
400	200	50.111.XXX

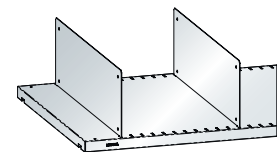

### TFT monitor bracket and keyboard shelf

TFT monitor bracket for attaching flat screens with a VESA base plate. Hole pattern 75 × 75 mm and 100 × 100 mm, continuously adjustable tilt angle. Keyboard shelf for mounting on the monitor holder. Versions: sheet steel. Colour: Light grey, RAL 7035.

Specification for	Width mm	Height mm	Depth mm	Art. no.
<b>Swivel arm</b>	120	155	60	<b>65.356.000</b>
<b>Keyboard support</b>	600	155	200	<b>65.357.000</b>



### Schematic diagram

The LED lighting and power supply system from LISTA meets the high requirements for modern and ergonomic workstations. The combined lamps and power strips make simple workstations functional system solutions for maximum ergonomics and cost-effectiveness. Good lighting and a tidy workstation are essential for high-quality, accurate work.

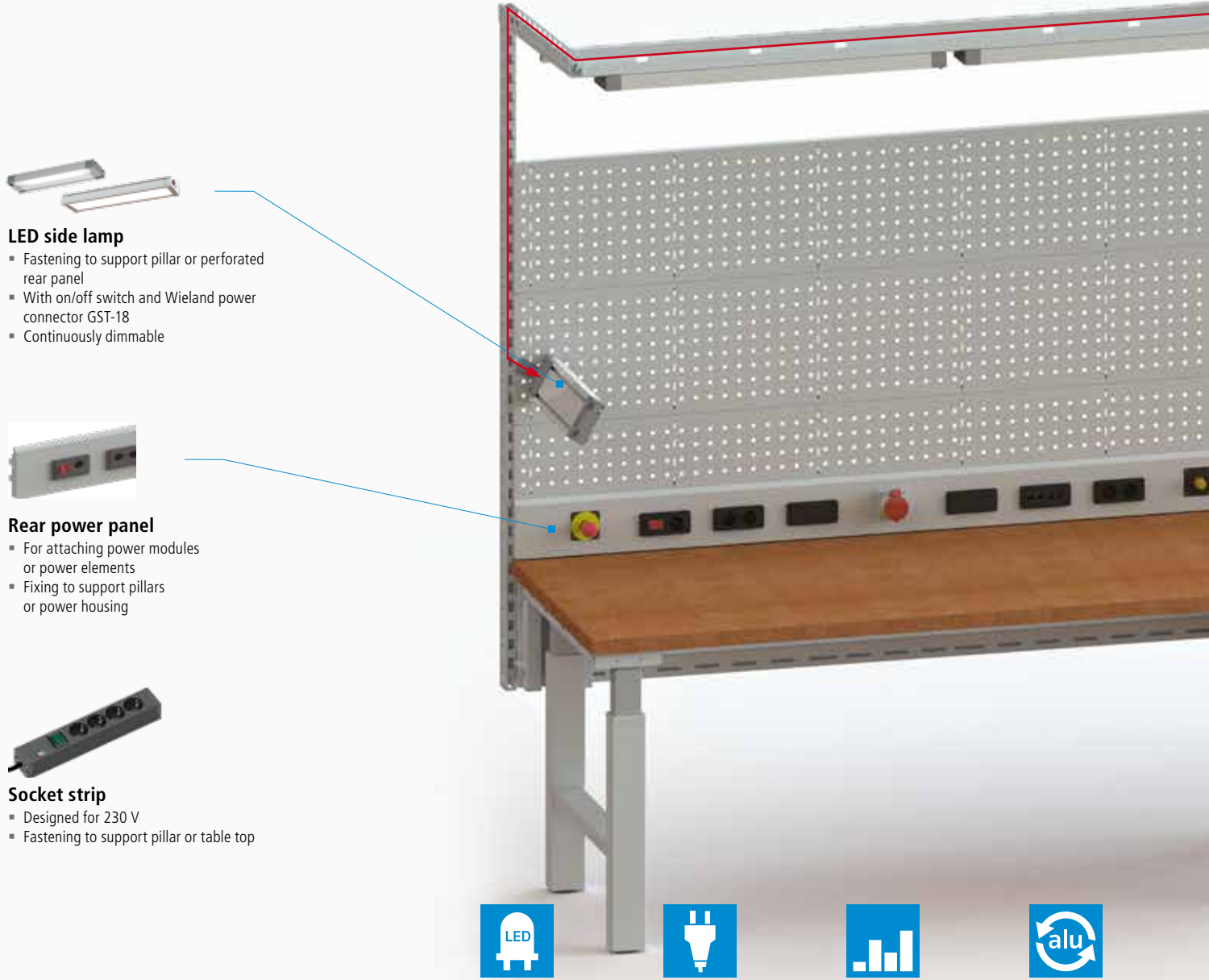

**LED side lamp**

- Fastening to support pillar or perforated rear panel
- With on/off switch and Wieland power connector GST-18
- Continuously dimmable

**Rear power panel**

- For attaching power modules or power elements
- Fixing to support pillars or power housing

**Socket strip**

- Designed for 230 V
- Fastening to support pillar or table top



LED technology  
5000 K



GST-18  
system plug



Continuously  
dimmable



Aluminium  
housing

**Lighting**

	LED technology 5000 K	GST-18 system plug	Continuously dimmable	Aluminium housing
<b>LED Comfort +</b>				
LED workstation lamp	●	●	●	●
LED side lamp	●	●	●	●
Articulated LED head lamp	●	-	●	●*
Articulated LED magnifier lamp	●	-	●	●*
<b>LED Comfort</b>				
LED workstation lamp	●	●	-	-
Side lamp	●	●	-	-



**LED workstation lamp**

- Fastening to lighting support
- With on/off switch and Wieland power connector GST-18



**Articulated LED magnifier light or articulated LED head light**

- Fastening to support pillar or table top
- With on/off switch
- Continuously dimmable



**Power strips**

- optionally with
- 3 × socket 230V
  - 3 × socket 230V and on/off switch
  - RCD

» For power modules/elements, see. p. 144 – 147



Power modules freely selectable



Freely selectable power elements



Integrated in rear panel



GST-18 system plug

**Power supply**

	Power modules freely selectable	Freely selectable power elements	Integrated in rear panel	GST-18 system plug
Rear power panel	●	●	●	●
Power enclosure	●	●	-	●
Power strips	-	-	-	●
Socket strip	-	-	-	-

## Rear power panels and housings

**Please note:**

All power elements must be wired on site.

**Rear power panel**

For attaching power modules or power elements (see page 145). Simple, tool-free mounting on support pillars or power housing. A blind cover (89.543.000) is mandatory for unused fields. Height: 150 mm. Model: Colour as per colour chart.

**Power housing**

The solution for mounting without support pillars. Direct mounting on the countertop, incl. punch-out at the side and base. Height: 150 mm. Model: Sheet steel, colour: as per colour chart.

**Cable trough**

The cable tray is used to hold routing cables neatly. Depending on the module widths, the cable tray can be inserted without tools, similar to a rear panel. Height: 350 mm. Model: Sheet steel, colour: as per colour chart.



Module width mm

	665	750	1000	1330	1500	2000
Art. no	Art. no	Art. no	Art. no	Art. no	Art. no	Art. no
<b>Rear power panel for power modules</b>	<b>89.014.XXX</b>	<b>89.015.XXX</b>	<b>89.016.XXX</b>	<b>89.017.XXX</b>	<b>89.018.XXX</b>	<b>89.019.XXX</b>
Layout						
Number of power modules	2	3	4	5	6	8
<b>Rear power panel for power modules and elements</b>	-	-	-	-	<b>89.020.XXX</b>	<b>89.021.XXX</b>
Layout						
Number of power modules					4	6
Number of power elements					3	3
<b>Housing</b>	-	-	<b>89.002.XXX</b>	-	<b>89.004.XXX</b>	<b>89.005.XXX</b>
<b>Cable trough</b>	<b>89.055.XXX</b>	<b>89.056.XXX</b>	<b>89.057.XXX</b>	<b>89.058.XXX</b>	<b>89.059.XXX</b>	<b>89.060.XXX</b>

## Power and connection cables

**System socket power cable**

Simple and quick electrical installation via 3-pin connector system. Length: 3 m.

Type	Art. no
<b>CH</b>	<b>89.544.000</b>
<b>Schuko</b>	<b>89.545.000</b>
<b>FR</b>	<b>89.545.000</b>
<b>GB</b>	<b>89.546.000</b>

**Intermediate coupling**

For interlinking power modules 1 – 4 and 6. Power modules which are not mounted next to one another are connected via a connection cable. Colour: black.

Type	Art. no
<b>Type I</b>	<b>89.552.000</b>
<b>Type T</b>	<b>89.551.000</b>
<b>Type U</b>	<b>89.577.000</b>

**Connection cable**

3-pin connector system with socket and plug.

Length m	Art. no
<b>0.5</b>	<b>89.547.000</b>
<b>1</b>	<b>89.548.000</b>
<b>2</b>	<b>89.549.000</b>
<b>3</b>	<b>89.550.000</b>

**Cable routing clip**

Set 8x	Art. no
<b>Set 8x</b>	<b>89.024.000</b>



## Power modules



<b>Power module 1</b> 1 × switch 1 × socket outlet 230 V	<b>Power module 1 type CH</b> 1 × overcurrent protection (thermal fuse 10A) 1 × switch	<b>Power module 2</b> 2 × socket 230 V	<b>Power module 3</b> 1 × single-pin circuit breaker, 16 A (CH: 10 A)	<b>Power module 4</b> 1 × FI safety switch 25A/30mA	<b>Power module 6</b> Emergency stop button
--	--	---	--	--	--

	Art. no.	Art. no.	Art. no.	Art. no.	Art. no.	Art. no.
	-	-	-	-	<b>89.541.000</b>	<b>89.540.000</b>
CH (Type J)	-	<b>89.598.000</b>	<b>89.530.000</b>	<b>89.579.000</b>	-	-
Schuko (Type F)	<b>89.535.000</b>	-	<b>89.531.000</b>	<b>89.542.000</b>	-	-
FR (Type E)	<b>89.536.000</b>	-	<b>89.532.000</b>	<b>89.542.000</b>	-	-
GB (Type G)	<b>89.537.000</b>	-	<b>89.533.000</b>	-	-	-



<b>Blind cover</b> for subsequent addition of power modules	<b>Power module 7</b> 2 × 2 RJ45 network sockets, without network cable, plug+play, cat 6	<b>Power module 8</b> 2 × DN7 compressed air connections, input: DN5 plug-in nipple, output: DN5 quick-release coupling	<b>Power module 9</b> 1 × socket outlet 230 V 2 × power USB	<b>Power module 10</b> 1 × socket outlet 230 V 1 × RJ45, without network cable, plug+play, cat 6	<b>Power module 11</b> 1 × overcurrent protection (thermal fuse 10A) 1 × socket outlet 230 V
--	--	--	---	--	--

	Art. no.	Art. no.	Art. no.	Art. no.	Art. no.	Art. no.
	<b>89.543.000</b>	<b>89.538.000</b>	<b>89.539.000</b>	-	-	-
CH (Type J)	-	-	-	<b>89.389.000</b>	<b>89.388.000</b>	<b>89.595.000</b>
Schuko (Type F)	-	-	-	<b>89.385.000</b>	<b>89.381.000</b>	-
FR (Type E)	-	-	-	<b>89.386.000</b>	<b>89.382.000</b>	-
GB (Type G)	-	-	-	<b>89.387.000</b>	<b>89.383.000</b>	-

## Power elements



<b>Emergency stop switch*</b> (Switching via the contactor)	<b>400 V 16 A socket **</b>	<b>Compressed air connection*</b> (Compatible: RECTUS 25 / RECTUS 1600 / 1625 TEMA 1600, connection G 3/8")	<b>Blind adapter plate</b>	<b>CEE 240 V socket*</b>
<b>89.100.000</b>	<b>89.090.000</b>	<b>89.105.000</b>	<b>89.088.000</b>	CH <b>89.101.000</b>
				Schuko <b>89.102.000</b>
				FR <b>89.103.000</b>
				GB <b>89.104.000</b>

\* Incl. adapter plate \*\* Direct mounting, without adapter plate

When using the emergency stop switch, 400 V socket or CEE 240 V, a protective cover (Art. no. **89.107.000**) on the rear must be fitted on site.

### Compressed air strip for support pillar

Compressed air strip for support pillar, with 2 compressed air boxes, inside diameter 7.2, and one coupling plug in the end cap. Including fastening material for support pillar. Specification: sheet steel. Colour: light grey, RAL 7035.

Connections				Art. no.
	mm	mm	mm	
<b>2 × Compressed air</b>	60	60	150	<b>65.281.000</b>



## LED Comfort +

**LED workstation lamp**

The workstation lamp is mounted on the lighting support (see page 139). With On/Off switch and Wieland power connector GST-18. Infinitely dimmable. Glare suppression: structured screen. Colour temperature: neutral white 5000 K. Colour reproduction: Ra > 80. Description: aluminium housing, colourless anodised. Including fastening material. Excluding power and connecting cable (see page 144). A Waldmann development.

Length mm	Power W	Luminous flux lm	max. illuminance lx*	System connection GST-18	Installation	Art. no.
450	15	1100	499	Input	-	<b>89.265.000</b>
900	35	3000	1279	Input/Output	-	<b>89.266.000</b>
1500	63	5000	1770	Input/Output	-	<b>89.267.000</b>

**LED side lamp**

The side lamp can be mounted on the support pillar or perforated rear panels. With On/Off switch and Wieland power connector GST-18. Infinitely dimmable. Glare suppression: structured screen. Colour temperature: neutral white 5000 K. Colour reproduction: Ra > 80. Description: aluminium housing, colourless anodised. Including fastening material. Excluding power and connecting cable (see page 144). A Waldmann development.

Length mm	Power W	Luminous flux lm	max. illuminance lx*	System connection GST-18	Installation	Art. no.
450	15	1100	499	Input	right	<b>89.268.000</b>
450	15	1100	499	Input	left	<b>89.269.000</b>

**LED swing arm lamp**

The swing arm lamp can be mounted on the support pillar or any position on the table top. With On/Off switch. Infinitely dimmable. Glare suppression: structured screen. Colour temperature: neutral white 5000 K. Colour reproduction: Ra > 80. Arm length: 823 mm. Description: Plastic housing and articulated arms of colourless anodised aluminium. Including table clamp. Separate fixing bracket for mounting on support pillar. Colour: grey, **89.183.000**. Including 3 m cable; mains plug CEE 7/16 (Europlug), BS 1363 and NEMA 1-15P. A Waldmann development.

Length mm	Power W	Luminous flux lm	max. illuminance lx**	Ballast	Installation	Art. no.
360	14	1330	2604	100–240V 50/60 Hz	-	<b>89.270.000</b>

**LED articulated arm magnifier lamp**

The articulated magnifier lamp can be mounted on the support pillar or any position on the table top. With On/Off switch. Infinitely dimmable. Colour temperature: neutral white 5000 K. Colour reproduction: Ra > 80. Arm length: 823 mm. Description: Plastic housing and articulated arms of colourless anodised aluminium. Including table clamp. Separate fixing bracket for mounting on support pillar. Colour: grey, **89.183.000**. Including 3 m cable; mains plug CEE 7/16 (Europlug), BS 1363 and NEMA 1-15P. A Waldmann development.

Magnifier	Dioptres	Power W	Luminous flux lm	max. illuminance lx***	Ballast	Art. no.
ø 160	3.5	15	-	7070	100–240V 50/60 Hz	<b>89.271.000</b>

## LED Comfort

**LED workstation lamp**

The workstation lamp is connected to the lighting support (see page 139). With On/Off switch and Wieland power connector GST-18. Colour temperature: neutral white 5000 K. Colour reproduction: Ra > 80. Description: PVC plastic housing, white including fastening material. Excluding power and connecting cable (see page 144).

Length mm	Power W	Luminous flux lm	max. illuminance lx*	System connection GST-18	Art. no.
450	10	1000	367	Input	<b>89.272.000</b>
900	30	3000	1073	Input/Output	<b>89.273.000</b>
1500	50	5000	1904	Input/Output	<b>89.274.000</b>

**LED side lamp**

The side lamp can be mounted on the support pillar or perforated rear panels. With On/Off switch and Wieland power connector GST-18. Colour temperature: neutral white 5000 K. Colour reproduction: Ra > 80. Description: PVC plastic housing, white including fastening material. Excluding power and connecting cable (see page 144).

Length mm	Power W	Luminous flux lm	max. illuminance lx*	System connection GST-18	Art. no.
450	10	1000	367	Input	<b>89.275.000</b>

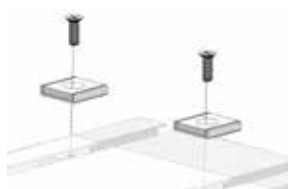
**Magnetic bracket for Comfort+ and Comfort**

Practical accessories for attaching LISTA Comfort + and Comfort workstation lighting to or under the cabinets using a magnet. Contents: 4 enclosed magnets incl. fastening material

Magnet set	Art. no.
	<b>89.262.000</b>

\*Measuring field: 100 × 100 cm/Measuring distance: 100 cm

\*\*Measuring field: 100 × 100 cm/Measuring distance: 50 cm

\*\*\*Measuring field: 30 × 30 cm/Measuring distance: 15 cm

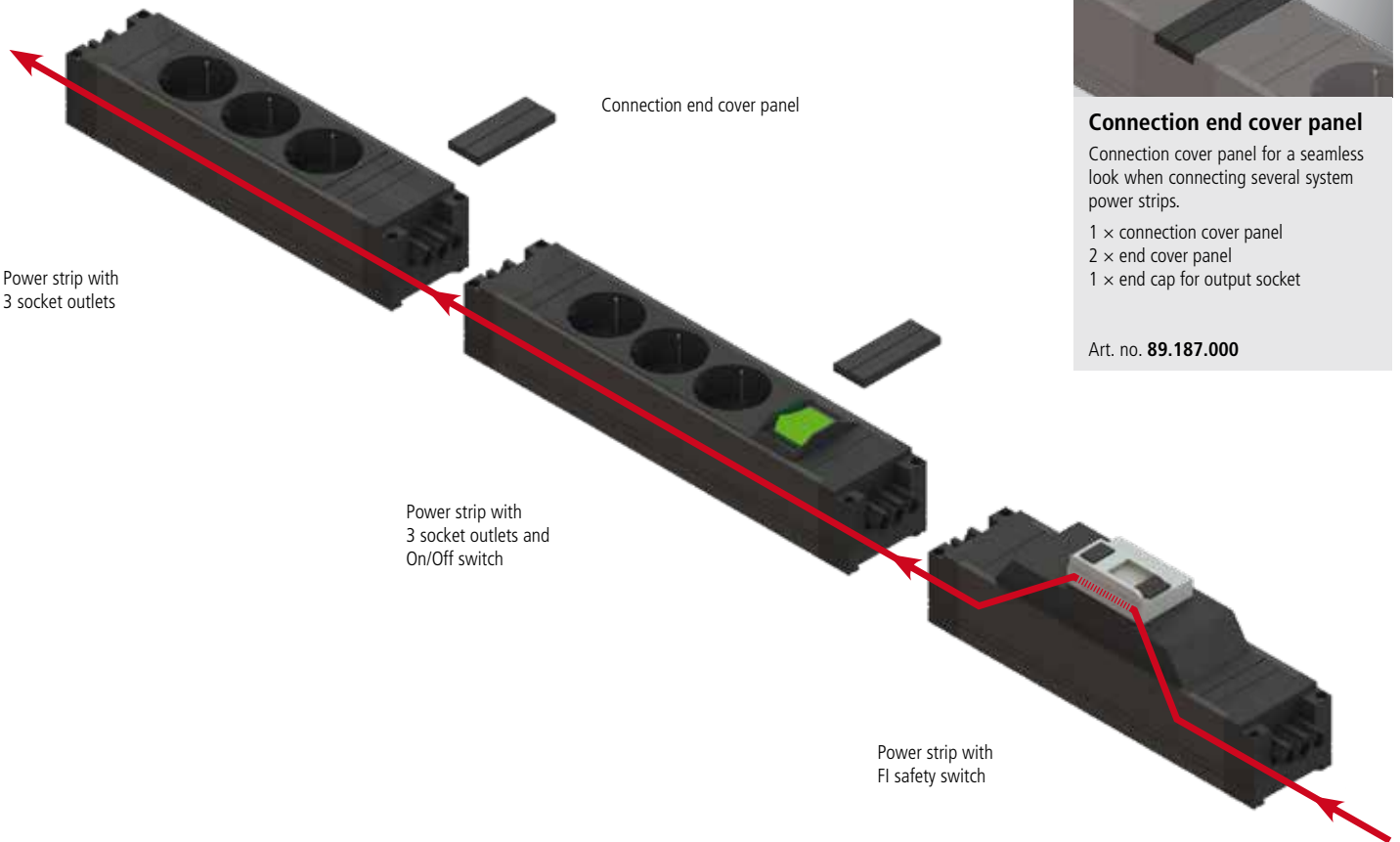

**Connection end cover panel**  
 Connection cover panel for a seamless look when connecting several system power strips.  
 1 × connection cover panel  
 2 × end cover panel  
 1 × end cap for output socket  
 Art. no. **89.187.000**



**System power strips**

Input/output via system connector 230 V (Wieland system connector GST-18). System power strips can be directly connected to each other. CH version with thermal fuse 10 A. Description: plastic, black. Including fastening material for support pillar bracket. Excluding power and connecting cable, see page 144.

Description	Connector type	On/Off switch	Socket outlets	Art. no.
<b>Power strip</b> with socket outlets 230 V	D / PE	-	3	<b>89.174.000</b>
	CH	-	3	<b>89.175.000</b>
	F	-	3	<b>89.176.000</b>
	GB	-	3	<b>89.177.000</b>
<b>Power strip</b> with socket outlets 230 V and On/Off switch	D / PE	●****	3	<b>89.178.000</b>
	CH	●****	3	<b>89.179.000</b>
	F	●****	3	<b>89.180.000</b>
	GB	●****	3	<b>89.181.000</b>
<b>Power strip</b> with FI safety switch*****	via GST-18	-	-	<b>89.182.000</b>

**Socket strip**

Designed for 230 V. CH version with thermal fuse 10 A. Description: plastic, black. Including fastening material for workbench top and support pillar bracket. Including connecting cable, length 2m.

Description	Connector type	On/Off switch	Socket outlets	Art. no.
<b>Socket strip</b> with sockets 230 V	D / PE	●	4	<b>89.170.000</b>
	CH	●	4	<b>89.171.000</b>
	F	●	4	<b>89.172.000</b>
	GB	●	4	<b>89.173.000</b>

# Hexagonal workbenches and vices

The space-saving hexagonal workbenches with vices are ideal as group workstations, especially for training centres. Every workstation has a large worktop and a drawer cabinet as substructure. The power outlets are integrated into the centre section.



## + Wide range of specifications in a modular system

for individual configuration and combination of drawer cabinets, power attachments and vices

## + Maximum workstation utilisation

ideal as group workstations for training facilities thanks to special design

## + Perfect power supply

thanks to the power attachment with freely configurable power elements and power modules, available as a single or double level attachment

## + Easy assembly

Power and compressed air connections are combined in the centre section and are very accessible thanks to the easily removable hexagonal cover plate

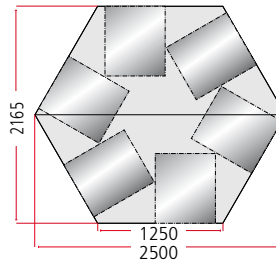

### Hexagonal workbenches

With Multiplex top and 6 drawer cabinets, including pre-assembly and fastening material.

Multiplex top thickness	<b>40 mm</b>
Height of drawer cabinet	800 mm
Drawer cabinet width	564 mm
Drawer cabinet depth	725 mm
Drawer load capacity	75 kg

### 27 × 36 E

459 × 612 mm



W	D	H		kg	6 cabinets with number of drawers each mm	Lock	Art. no.
mm	mm	mm					
2500	2165	840	Multiplex	1500	4: 2 × 100 / 1 × 200 / 1 × 300	KEY Lock	<b>89.200.XXX</b>
2500	2165	840	Multiplex	1500	5: 1 × 50 / 2 × 100 / 1 × 150 / 1 × 300	KEY Lock	<b>89.201.XXX</b>



### Power attachment module

in double-decker version

For power modules/elements, see p. 145



### Hexagonal power attachment covers

For attaching power modules or power elements (see page 145). 6 attachment covers are required in each case; here you can freely choose between the two variants.

Edge length mm	H	Number of power modules	Number of power elements	Art. no.
mm	mm			
620	155	2	-	<b>89.080.XXX</b>
620	155	1	2	<b>89.081.XXX</b>



### Hexagonal cover plate

Multiplex 20 mm, incl. grooved recess for attaching and securing the power attachment covers.

Edge length mm	Art. no.
531	<b>89.083.000</b>



When ordering a workbench from these two pages with **CODE Lock**, please add the suffix "**C**" or for **RFID** or **AUTO Lock** "**F**" or "**A**" in addition to the article number from the table (e.g. **78.897.XXX.C**).

Locking systems see pp. 28–31



### "Gressel" vice system

Forward-opening vice with off-centre design enables vertical clamping of up to 4 inch round stock. With protected square guide, for maintenance-free precision. Unlimited applications thanks to the patented 90° swivelling clamp. Anvil and saddle aids enable optimum machining of pipes and other work pieces. Specification: spheroidal graphite iron, with two exchangeable hewn jaws, fastening material included. Colour: stationary elements dust grey, RAL 7037, movable elements cobalt blue, RAL 5013.

Specification	Opening of jaws mm	Jaw width mm	Art. no.
<b>Gressel AX 100</b>	110	100	<b>39.983.000</b>
<b>Gressel AX 125</b>	135	125	<b>39.984.000</b>
<b>Gressel AX 160</b>	170	160	<b>39.985.000</b>

### "Heuer" vice system

Forward-opening vice for vertical clamping of round material, centrally adjustable guides, forged tube jaws and strong anvil as well as fixed jaws. Proven double prismatic guide prevents dirt and damage. Two-year guarantee. Specification: drop-forged steel, surface-hardened fixed jaws, Spindle completely galvanised, including fastening material. Colour: Anthracite grey, RAL 7016

Specification	Opening of jaws mm	Jaw width mm	Art. no.
<b>Heuer 100120</b>	150	120	<b>44.990.000</b>
<b>Heuer 100140</b>	200	140	<b>44.991.000</b>

### Pre-assembly of "Gressel" and "Heuer" vice

Pre-assembly (holes) excluding fastening material.

Position pre-assembly	Art. no.
<b>left</b>	<b>44.131.000</b>
<b>centre</b>	<b>44.132.000</b>
<b>right</b>	<b>44.133.000</b>

**Note**  
With workbench tops not made of solid wood (e.g. Urphen, resin), vice underlays are mandatory (on request).



Vice cabinet on request.



# Compact workbenches

- + Utmost stability**  
housing can be loaded with up to 1.0 t.,  
all connections welded
- + Space-saving and well-organised storage**  
in variable substructures with smooth-running drawers  
with 75 kg supported load and a wide range of  
partition material
- + Secure locking system**  
with KEY Lock locking system for simultaneous  
protection of all drawers and doors against  
unauthorised access
- + Great design diversity**  
thanks to the wide range of components,  
substructures, materials and surfaces
- + Easy to use and highly ergonomic**  
with height-adjustable workbench legs for  
optimum working heights and leg room – also  
available for our modular superstructure system
- + Easily adaptable to  
new working environments**  
through flexible integration and reconfiguration  
of the modular system
- >> Universal superstructures**  
see p. 132

**Compact workbenches made by LISTA provide versatile, modern workstations for production, workshop and hobby use.** Their robust design and high-quality materials make them especially durable and able to withstand even severe conditions. Various substructures ensure that there is plenty of storage space.



Art. no. **64.127.020**  
Pale grey, RAL 7035

**D** ↗ 700 mm      **H** ↑ 840 / 850 mm

500 × 600 mm

	Top width mm	Housing mm	<b>H</b> ↑ mm	Number of drawers mm	Compartments with doors	Shelves	Art. no.
	1000	640	840	Multiplex 1: 1 × 150	1 × 350	1	<b>64.103.XXX</b>
	1000	640	850	Beech 1: 1 × 150	1 × 350	1	<b>64.105.XXX</b>
	1000	640	840	Multiplex 4: 2 × 100 / 2 × 150	-	-	<b>64.106.XXX</b>
	1000	640	850	Beech 4: 2 × 100 / 2 × 150	-	-	<b>64.108.XXX</b>
	1500	1230	840	Multiplex 4: 2 × 75 / 1 × 150 / 1 × 200	1 × 500	2	<b>64.115.XXX</b>
	1500	1230	850	Beech 4: 2 × 75 / 1 × 150 / 1 × 200	1 × 500	2	<b>64.117.XXX</b>
	1500	1230	840	Multiplex 2: 2 × 150	2 × 350	2	<b>64.118.XXX</b>
	1500	1230	850	Beech 2: 2 × 150	2 × 350	2	<b>64.120.XXX</b>
	2000	1820	840	Multiplex 4: 3 × 150 / 1 × 200	1 × 350	3	<b>64.124.XXX</b>
	2000	1820	850	Beech 4: 3 × 150 / 1 × 200	1 × 350	3	<b>64.126.XXX</b>
	2000	1820	840	Multiplex 7: 5 × 100 / 2 × 150	2 × 350	2	<b>64.127.XXX</b>
	2000	1820	850	Beech 7: 5 × 100 / 2 × 150	2 × 350	2	<b>64.129.XXX</b>
	2000	1820	840	Multiplex 2: 2 × 150	2 × 350	2 / 2*	<b>64.130.XXX</b>
	2000	1820	850	Beech 2: 2 × 150	2 × 350	2 / 2*	<b>64.132.XXX</b>
	2500	2410	840	Multiplex 10: 4 × 75 / 4 × 100 / 2 × 150	2 × 500	4	<b>64.133.XXX</b>
	2500	2410	850	Beech 10: 4 × 75 / 4 × 100 / 2 × 150	2 × 500	4	<b>64.135.XXX</b>
	3000	2410	840	Multiplex 10: 4 × 75 / 4 × 100 / 2 × 150	2 × 500	4	<b>64.136.XXX</b>
	3000	2410	850	Beech 10: 4 × 75 / 4 × 100 / 2 × 150	2 × 500	4	<b>64.138.XXX</b>

\* centre recessed shelves.

### Compact workbenches

With Multiplex or beech worktop and housing.

Multiplex top thickness	<b>40 mm</b>
Beech top thickness	<b>50 mm</b>
Height of workbench substructure	800 mm
Depth of housing/ worktop	695 / 700 mm
Drawer load capacity	75 kg
Shelf load capacity	25 kg

#### Note

Preconfigured workbenches are equipped with various types of locks. Other worktop specifications (Urphen, chrome steel coating) on request.



### Universal superstructures

The modular system – for universal use with all LISTA workbenches and workstation systems. The compatible superstructure system stands out in terms of ease of integration. Only compatible when mounting on table top.

- Universal superstructures see p. 132
- Separate components see p. 154



### High load capacity up to 1.0 t

The sturdy construction and high-quality materials provide a stable system. Can therefore handle total loads of up to 1.0 t without any problems.

For colour information see fold-out page. When ordering, please use the desired three-digit colour code (instead of XXX).

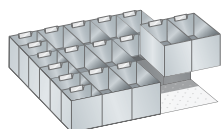

### Plastic box set

For drawer height mm	Art. no.
<b>75</b>	<b>56.160.000</b>
<b>100, 125</b>	<b>56.161.000</b>
12 plastic boxes:	100 × 200 mm
6 plastic boxes:	100 × 100 mm

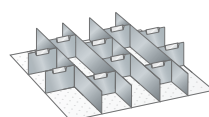

### Partition set

For drawer height mm	Art. no.
<b>75</b>	<b>56.172.000</b>
<b>100, 125</b>	<b>56.173.000</b>
<b>150</b>	<b>56.174.000</b>
4 lengthwise dividers	
10 crosswise dividers	100 mm

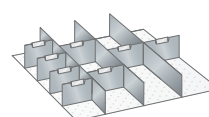

### Partition set

For drawer height mm	Art. no.
<b>75</b>	<b>56.175.000</b>
<b>100, 125</b>	<b>56.176.000</b>
<b>150</b>	<b>56.177.000</b>
<b>200, 150</b>	<b>56.178.000</b>
3 lengthwise dividers	
4 crosswise dividers	100 mm
4 crosswise dividers	150 mm

# System workbenches

**LISTA system workbenches give you a stable and affordable solution for workstations in workshops and production areas.** These practical solutions not only impress with their robust design and quality but also offer outstanding value for money.



**+ Utmost stability**  
housing has a load capacity of up to 1.0 t with strong construction components

**+ Space-saving and well-organised storage**  
in variable substructures with smooth-running drawers with up to 50 kg supported load and a wide range of partition material

**+ Secure locking system**  
with KEY Lock locking system for simultaneous protection of all drawers and doors against unauthorised access

**+ Fully mobile**  
can be equipped with rubber castors for mobile use in a variety of workplaces

**>> Universal superstructures**  
see p. 132





Art. no. **41.769.050**  
 Housing: Light grey, RAL 7035.  
 Fronts: Metallic grey, NCS S 6502-B  
 (excluding vice)

**D** **700 mm**      **H** **840 / 877 mm**

459 × 510 mm	Top width mm	Housing mm	877	Number of drawers mm	Compartments with doors	Adjustable shelves	Art. no.
	1250	1116	877	Multiplex 6: 2 × 75 / 4 × 150	1 × 450	-	<b>41.514.XXX</b>
	1250	1116	877	Multiplex 5: 2 × 75 / 1 × 100 / 1 × 150 / 1 × 200	1 × 600	1	<b>41.769.XXX</b>
	1500	1116	840	Multiplex 2: 2 × 150	2 × 450	-	<b>41.430.XXX</b>
	1500	1116	840	Multiplex 5: 1 × 100 / 3 × 150 / 1 × 200	1 × 450	-	<b>41.438.XXX</b>
	2000	1654	840	Multiplex 6: 6 × 150	2 × 450	-	<b>41.721.XXX</b>
	2000	1654	840	Multiplex 3: 3 × 200	1 × 600	2	<b>41.722.XXX</b>

**System workbenches**

With Multiplex top and housing.  
 Multiplex top thickness **40 mm**  
 Height of housing 680 mm  
 Clear width of housing 600 mm  
 Height of workbench leg assemblies 120 mm

All mobile system workbenches are also equipped with 1 push handle, 4 castor holders with 2 fixed and 2 swivel castors with brakes (solid rubber Ø 125 mm)  
 Height of castor holders including castors 157 mm  
 Load capacity 400 kg

**Note:** Preconfigured workbenches are equipped with various types of locks. Other worktop specifications on request.



**Mobile workbench with push handle**

Also available as mobile design with two swivel castors and two fixed castors made of solid rubber, with brakes and push handle, supported load per castor 100 kg. The push handle for mobile system workbenches is ergonomic and stable and made from plastic-coated tubular steel.



**Universal superstructures**

The modular system – for universal use with all LISTA workbenches and workstation systems. The compatible superstructure system stands out in terms of ease of integration.

**Note**  
 Only compatible when mounting on table top.

Universal superstructures see p. 132

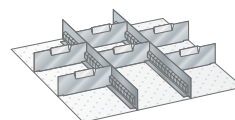
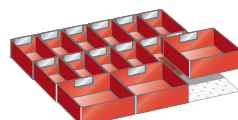
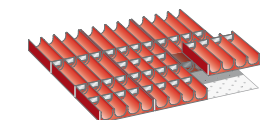

**Trough sets**

For drawer height mm	Art. no.
<b>75–300</b>	<b>41.468.000</b>
9 troughs:	4 trough parts, Ø33 mm*
40 trough walls:	4 trough parts, Ø33 mm*

**Sets of plastic boxes**

For drawer height mm	Art. no.
<b>75</b>	<b>41.471.000</b>
<b>100</b>	<b>41.472.000</b>
12 plastic boxes:	75 × 150 mm
3 plastic boxes:	150 × 150 mm

**Slotted dividers and metal separators**

For drawer height mm	Art. no.
<b>75</b>	<b>41.477.000</b>
<b>100</b>	<b>41.478.000</b>
<b>150–300</b>	<b>41.479.000</b>
2 slotted dividers:	30 E
6 metal separators:	9 E

Separate components see p. 155

**Note**  
 Internal drawer height lower than drawer front. For partition material height see p. 262–265.  
 Partition material sets without clip-on label holder.

\* Note usable height of the drawer depending on the goods to be stored.



# Compact workbenches | Individual parts



## Compact workbench substructure

To secure all drawers simultaneously, the workbench housing can be individually configured with the KEY Lock locking system. In addition, different drawer heights and doors can be selected.

**D** 700 mm **H** 800 mm



<b>W</b> for top width mm	1000	1500	2000	2500	3000
<b>Base</b>	Art. no.	Art. no.	Art. no.	Art. no.	Art. no.
without shelves	64.300.XXX	64.301.XXX	64.302.XXX	64.303.XXX	64.303.XXX
with 2 recessed shelves	–	–	64.304.XXX	–	–
housing (W × D mm)	640 × 695	1230 × 695	1820 × 695	2410 × 695	2410 × 695
Clear height (mm)	500	500	500	500	500
Number of compartments	1	2	3	4	4
<b>+ KEY lock separately lockable</b>	64.417.000	64.417.000	64.417.000	64.417.000	64.417.000
Number of locks required	1	1	2	2	2

### Floor anchoring

can be attached, retrofitable	90.177.000	90.177.000	90.177.000	90.177.000	90.177.000
-------------------------------	------------	------------	------------	------------	------------

### Height adjustment

retrofitable. Height-adjustable in 50 mm increments of 800–1050 mm.  
Colour: Anthracite grey, RAL 7016

64.414.000	64.414.000	64.414.000	64.409.000	64.409.000
Set with 4 pieces	Set with 4 pieces	Set with 4 pieces	Set with 6 pieces	Set with 6 pieces



### Multiplex panels

Beechwood top glued in multiple layers, sanded and surface-treated, bevelled top edges.

Thickness 40 mm	64.570.000	64.571.000	64.572.000	64.573.000	64.574.000*
-----------------	------------	------------	------------	------------	-------------

### Multiplex with chrome steel sheet coating

1,5 mm thick, bent down and screwed at the back, open on the sides, multiplex top is visible.

Thickness 40 mm	85.246.000	85.247.000	85.248.000	85.249.000	85.250.000
-----------------	------------	------------	------------	------------	------------

### Beechwood top

solid glued beech top, sanded and surface-treated. Bevelled long edges, for high mechanical load.

Thickness 50 mm	64.580.000	64.581.000	64.582.000	64.582.000	64.584.000
-----------------	------------	------------	------------	------------	------------

\*2 × 1500 mm with butt joint

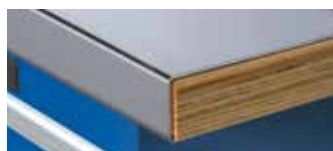

## Drawer

Every drawer has a full extension runner with a load capacity of 75 kg.

<b>W</b> × <b>D</b> Usable surface mm	500 × 600		
<b>H</b> Usable height mm	Cladding height mm	Art. no.	
75	60	45	64.400.XXX
100	85	75	64.401.XXX
150	135	125	64.403.XXX
200	185	175	64.404.XXX
250	235	175	64.405.XXX

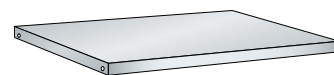

## Shelf

Galvanised and height adjustable. Shelf thickness 25 mm, load capacity 25 kg.

<b>W</b>	<b>D</b>	Art.-Nr.
600	600	64.413.000

## Hinged door

Model: 1-wing.

<b>H</b>	<b>W</b>	Model	Art. no.
500	600	left / right	64.410.XXX
350	600	right	64.411.XXX
350	600	left	64.412.XXX

Ordering information see p. 155



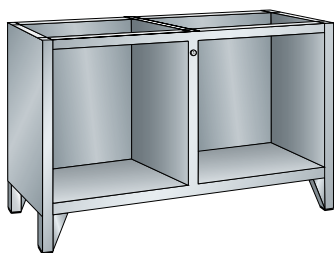

## System workbench substructure

Workbench base substructures with friction-locking plug and screw-type connection. External and internal panels with slotted perforations. For plugging in workbench installations. With central locking but without cylinder (must be ordered separately). Colour: Pale grey, RAL 7035.

**D** 700 mm    **H** 800/837 mm for mobile

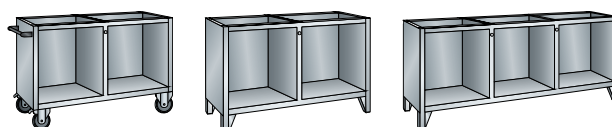

**W** for top width mm

	1250	1500	2000
<b>Base</b>	Art. no.	Art. no.	Art. no.
stationary	<b>41.957.020</b>	<b>41.957.020</b>	<b>41.956.020</b>
mobile*	<b>41.958.020</b>	–	–
housing (W × D mm)	1164 × 600	1164 × 600	1654 × 600
Clear height (mm)	600	600	600
Number of compartments	2	2	3
<b>+ KEY lock separately lockable</b>	<b>41.603.000</b>	<b>41.603.000</b>	<b>41.603.000</b>
Number of locks required	1	1	2

\***Equipment:** 1 push handle, 4 castor supports with 2 block and 2 swivel castors with brakes (solid rubber Ø 100 mm)



## Multiplex tops

Beechwood top glued in multiple layers, sanded and surface-treated, bevelled top edges.

Thickness  
40 mm

**88.613.000**    **88.614.000**    **88.615.000**

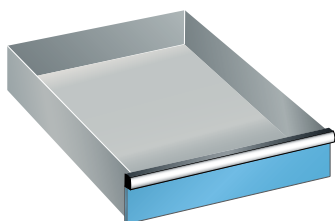

## Drawers

With ball bearing, inc. guide rails. The drawer walls have a slotted grid on all sides on the inside. The fronts are equipped with continuous handles with integrated label strips and transparent covers.

<b>W</b> × <b>D</b>	Usable surface mm		459 × 510	459 × 510
<b>H</b>	Usable height mm	Cladding height mm	Art. no.	Art. no.
75	60	50	<b>41.598.XXX</b>	<b>41.725.XXX</b>
100	90	75	<b>41.599.XXX</b>	<b>41.726.XXX</b>
150	140	125	<b>41.600.XXX</b>	<b>41.727.XXX</b>
200	190	125	<b>41.601.XXX</b>	<b>41.728.XXX</b>
300	290	125	<b>41.602.XXX</b>	<b>41.729.XXX</b>
Model			stationary	mobile
Load capacity			50 kg	30 kg

## Hinged doors

Sheet steel door with plastic recessed grip. Optionally mounted on the right or left.

<b>H</b>	Model	Art. no.
450	left	<b>41.583.XXX</b>
450	right	<b>41.584.XXX</b>
600	left	<b>41.585.XXX</b>
600	right	<b>41.586.XXX</b>

## Shelves

Shelves adjustable on a 25:25 mm grid, optionally as open compartments or behind a hinged door. Incl. shelf support. Shelf thickness 25 mm. Model: Sheet steel. Colour: Galvanised.

Shelf	Art. no.
	<b>41.587.000</b>
Usable dimensions (W × D)	493 × 539 mm

## Ordering information

When selecting drawers and hinged doors, the clear height of the base is decisive. The sum of the drawer front heights (C) must be equal to the clear height (B).

### Compact workbenches

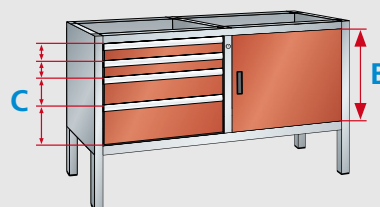

### System workbenches

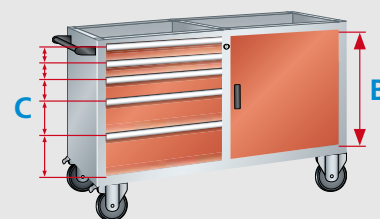

# Assembly trolleys

**LISTA assembly trolleys optimise material flow between individual workstations, warehouse and dispatch.** They enable fast transportation and interim storage of components or assemblies without requiring a lot of space and by combining various elements, they can be adapted specifically to individual requirements.

## + Utmost stability

total load capacity up to 250 kg, integrated storage shelf

## + Great design diversity and mobility

can be assembled on one side or on both sides, stationary or mobile

## + Ergonomic and safe handling

with four swivel castors and push handle

## + Easy assembly

through support pillar profiles perforated on four sides so that rear panels, swivel shelves and adjustable shelves and container strips can be attached at height increments of 50 mm largely without the use of tools

## >> Universal superstructures

see p. 132



Keyhole hook  
see p. 163

Storage container  
see p. 162



### Easy assembly

- swivel and adjustable shelves and container strips can be attached to the support pillar without the use of tools
- ribbed mats and raised sides provide the required stability for the stored items

### Ergonomic handling

- with four swivel castors and push handle
- two locking mechanisms for fixing

## 1 Mobile assembly stand

The assembly trolleys can have elements attached on both sides. The support pillars enable rear panels, swivel shelves or adjustable shelves as well as container strips to be mounted without the use of screws. The assembly trolleys are equipped with 4 swivel castors, 2 of which have braking mechanisms. Wheel diameter 100 mm, rubber, grey, max. load capacity 250 kg. Specification: Assembly stand comprising crossbars, shelves and support pillars, made of steel profile, perforated on four sides at 50 mm increments. Colour: as per colour chart. Roller housing made of galvanised and chrome-plated sheet steel.

## 2 Push handle for assembly trolley

The push handle is fixed to the side of the support pillar of the assembly stand; includes fastening material. Specification: aluminium tubing, black, anodised, with plastic holder. Colour: black, RAL 9005.

## 3 Ribbed mat, double-sided

Specification: rubber, colour: grey.

## 4 Perforated rear panels

The support pillars can be vertically fitted with rear panels, either partially or up to their full height. All rear panels can be attached to the support pillars without screws. Rear panels perforated with square holes 10 × 10 mm, 38 mm division and slots 380 mm apart for accommodating storage shelves and can holders (see page 141). Specification: sheet steel. Colour: as per colour chart.

## 5 Container strips

To hold size 2, 3 and 4 storage containers; can be attached to the support pillars without screws. Max. load capacity 15 kg. Specification: sheet steel. Colour: as per colour chart.

## 6 Safety bracket for container strips for assembly trolley

Safety bracket for container strips. For retrofitting. Is attached to the container strip to prevent any open-ended containers detaching from the container fixing strip in case of uneven flooring. Fastening material included. Specification: sheet steel. Colour: as per colour chart.

## 7 Adjustable shelves, plain, with side panel for assembly trolley

The raised sides prevent the transported goods slipping out in case of uneven floors. The adjustable shelves can be attached with the stop bar on either the front or the rear. Using two brackets, the adjustable shelves are attached to the support pillars without screws, either horizontally or with an inclination angle of 15°. Load capacity 50 kg. Normal level 25 mm + 17 mm stop bar. Including two brackets and a safety catch each. Specification: sheet steel. Colour: as per colour chart.

W → for module width mm				665	1330
	Assembly	Width mm	Depth mm	Usable height mm	Art. no.
<b>double-sided</b>	715	710	1250	<b>89.938.XXX</b>	-
<b>double-sided</b>	1380	710	1250	-	<b>89.941.XXX</b>

Height mm	Diameter mm	Art. no.	Art. no.
<b>500</b>	20	<b>89.950.000</b>	<b>89.950.000</b>

Usable width mm	Usable depth mm	Nominal depth mm	Art. no.	Art. no.
<b>714</b>	695	710	<b>89.946.000</b>	-
<b>1379</b>	695	710	-	<b>89.949.000</b>

Specification	Height mm	Usable width mm	Art. no.	Art. no.
<b>perforated</b>	350	655	<b>89.037.XXX</b>	-
<b>perforated</b>	350	1320	-	<b>89.040.XXX</b>

Height mm	Usable width mm	Art. no.	Art. no.
<b>85</b>	660	<b>65.234.XXX</b>	-
<b>85</b>	1325	-	<b>65.235.XXX</b>

Container size	2	3	4	2	3	4
Number of containers	6-12	6	4	12-24	12	8
<b>85</b>	660			<b>65.087.XXX</b>		
<b>85</b>	1325			-		
				<b>65.089.XXX</b>		

Specification	Depth mm	Usable width mm	Art. no.	Art. no.
<b>plain</b>	300	664	<b>89.870.XXX</b>	-
<b>plain</b>	300	1329	-	<b>89.871.XXX</b>
<b>Safety catch (per pair)</b>			<b>90.360.000</b>	<b>90.360.000</b>

## i Safety instructions

Due to a risk of toppling, only adjustable shelves with a maximum depth of 300 mm or swivelling shelves may be used.



## Test and inspection workstations

With its modular test and inspection workstations, LISTA offers optimised solutions for modern quality assurance practices. A variety of different test stations can be assembled from our wide selection of components in order to meet your individual needs and fulfil the most demanding requirements. You can be assured of one thing: system-based quality.





**+ Utmost stability**  
through high-quality welded sheet steel construction

**+ Great design diversity and modularity**  
for individual configuration and combination of top-mounted monitor cabinets with drawer and hardware cabinets

**+ Secure locking system**  
with roller shutters, drawers, monitor doors and hinged doors to protect expensive hardware and important documents

**+ Fully mobile**  
for mobile version

**+ User-friendly**  
thanks to lockable keyboard drawer with full extension runner for keyboard and mouse

**+ Perfect cable management**  
through cable conduits and openings for horizontal and vertical cable ducts

**+ Optionally with lighting, power strip and ventilator**  
for an optimum working environment

**>> Benefits of LISTA drawer cabinets**  
see p. 38/39

# Test and inspection workstations | preconfigured



## Computer cabinet

- 1 Monitor stand
- 2 Hardware cabinet
- 3 Pair of castor holders

Art no. **17.616.020**  
Light grey, RAL 7035  
(including push bar)



## Computer cabinets

Computers and the corresponding hardware and software must be protected from dust, dirt and unauthorised access on the shop floor. The LISTA computer cabinet provides a safe and proven solution that fulfils this requirement. Equipped with:

- 1 monitor compartment with retracting door or hinged door mounted on the right, each with cylinder lock,
- 1 plain adjustable shelf in the monitor compartment with retracting door,
- 1 lockable 75 mm keyboard drawer with full extension runner,
- 1 hardware cabinet with hinged doors including lock, permanently installed power supply consisting of a 4-socket power strip (230 V) with illuminated switch, equipment extension, plain adjustable shelf,
- 1 built-in fan,
- 1 connecting cable, 5 m long,
- 1 opening in the rear panel, with removable cover
- 1 push rod (for mobile version)

### Computer cabinets with retracting doors

Stationary and mobile version:  
with mobile versions, nylon castors, Ø 100 mm,  
monitor door can be swung upward,  
monitor compartment usable dimensions  
(W × D × H): 650 × 620 × 605 mm,  
size of viewing window (W × H): 445 × 525 mm

### Computer cabinets with hinged door mounted on the right

Stationary and mobile version:

- with mobile versions, nylon castors, Ø 100 mm
- Monitor door mounted on the right
- monitor compartment usable dimensions / monitor stand (W × D × H): 710 × 325 × 730 mm
- size of viewing window (W × H): 653.5 × 721 mm



## Computer cabinets

Computer cabinets protect electronic equipment in dusty and dirty surroundings. A central power input facilitates power supply to the hardware.

**36 × 36 E**

**W → 717 mm**

**D ↗ 725 mm**



H ↑	Specification/type	Working height mm	Art. no.
1625	without power strip	880	17.640.XXX
1625	CH	880	17.641.XXX
1625	D / PE	880	17.642.XXX
1625	F	880	17.643.XXX
1625	GB	880	17.644.XXX



1762	without power strip	1020	17.645.XXX
1762	CH	1020	17.646.XXX
1762	D / PE	1020	17.647.XXX
1762	F	1020	17.648.XXX
1762	GB	1020	17.649.XXX



1800	without power strip	1000	17.610.XXX
1800	CH	1000	17.611.XXX
1800	D / PE	1000	17.612.XXX
1800	F	1000	17.613.XXX
1800	GB	1000	17.614.XXX



1937	without power strip	1140	17.615.XXX
1937	CH	1140	17.616.XXX
1937	D / PE	1140	17.617.XXX
1937	F	1140	17.618.XXX
1937	GB	1140	17.619.XXX

**D → 717 mm**

**H ↗ 350 mm**

**W ↑ 800 mm**



Monitor stand	Doors mounted	Art. no.
Full glass doors made from safety glass. Punch-outs for cable routing KEY lock individually lockable	right	69.885.XXX
	left	69.886.XXX

### Accessories

Model	Art. no.
Cover flap set	1 × cable collar, 2 × cover flap 69.869.000
Adjustable shelf	smooth, load capacity 40 kg, adjustment grid 25 mm 69.889.XXX



## Quality Station

- 1** Quality cabinet
- 2** Hard laminate top
- 3** Hardware cabinet
- 4** Drawer cabinet
- Support bases with privacy screen

\*excluding adjustable shelf  
Art. no. **16.808.000**

Art. no. **17.826.020**  
Light grey, RAL 7035.



## Quality Station

The Quality Station is perfectly suited for performing, recording and archiving test results in the production process and can be flexibly adapted. Files, reports and hardware are stored safely.

**2 x 36 x 36 E** **W** → 1434 mm **D** ↗ 725 mm

» suitable partition material for drawers see page 248



H	Specification/type	Working height mm	of drawers mm	Equipment extension	Art. no.
1900	without power strip, without lamp	750	-	1	17.800.XXX
1900	CH	750	-	1	17.801.XXX
1900	D / PE	750	-	1	17.802.XXX
1900	F	750	-	1	17.803.XXX
1900	GB	750	-	1	17.804.XXX
1900	without power strip, without lamp	750	2 x 300	-	17.805.XXX
1900	CH	750	2 x 300	-	17.806.XXX
1900	D / PE	750	2 x 300	-	17.807.XXX
1900	F	750	2 x 300	-	17.808.XXX
1900	GB	750	2 x 300	-	17.809.XXX
2100	without power strip, without lamp	950	-	1	17.820.XXX
2100	CH	950	-	1	17.821.XXX
2100	D / PE	950	-	1	17.822.XXX
2100	F	950	-	1	17.823.XXX
2100	GB	950	-	1	17.824.XXX
2100	without power strip, without lamp	950	1 x 100 / 2 x 300	1	17.825.XXX
2100	CH	950	1 x 100 / 2 x 300	1	17.826.XXX
2100	D / PE	950	1 x 100 / 2 x 300	1	17.827.XXX
2100	F	950	1 x 100 / 2 x 300	1	17.828.XXX
2100	GB	950	1 x 100 / 2 x 300	1	17.829.XXX
2200	without power strip, without lamp	1050	1 x 75	1	17.830.XXX
2200	CH	1050	1 x 75	1	17.831.XXX
2200	D / PE	1050	1 x 75	1	17.832.XXX
2200	F	1050	1 x 75	1	17.833.XXX
2200	GB	1050	1 x 75	1	17.834.XXX

## Quality Stations

Specification depending on model with the following system modules:

### Quality cabinet

With plastic roller shutters including cylinder lock, connection cable 3 m long, hard laminate top as working surface, fitted without tools, power supply with 2-socket and 3-socket power outlet and rocker switch for the lamp built into the housing cover

### Hardware cabinet

With hinged doors including lock, permanently installed power supply consisting of a 4-socket power strip (230 V) with illuminated switch, equipment extension, connecting cable 5 m long, lockable 75 mm keyboard drawer with full extension runner

### Drawer cabinet

With full extension runner, drawer load capacity 75 kg

### Support base

With privacy screen



## Mobility

All test and inspection workstations are also available in a mobile version. This allows you to quickly and efficiently adapt to changing requirements.



# Storage containers and keyhole hooks



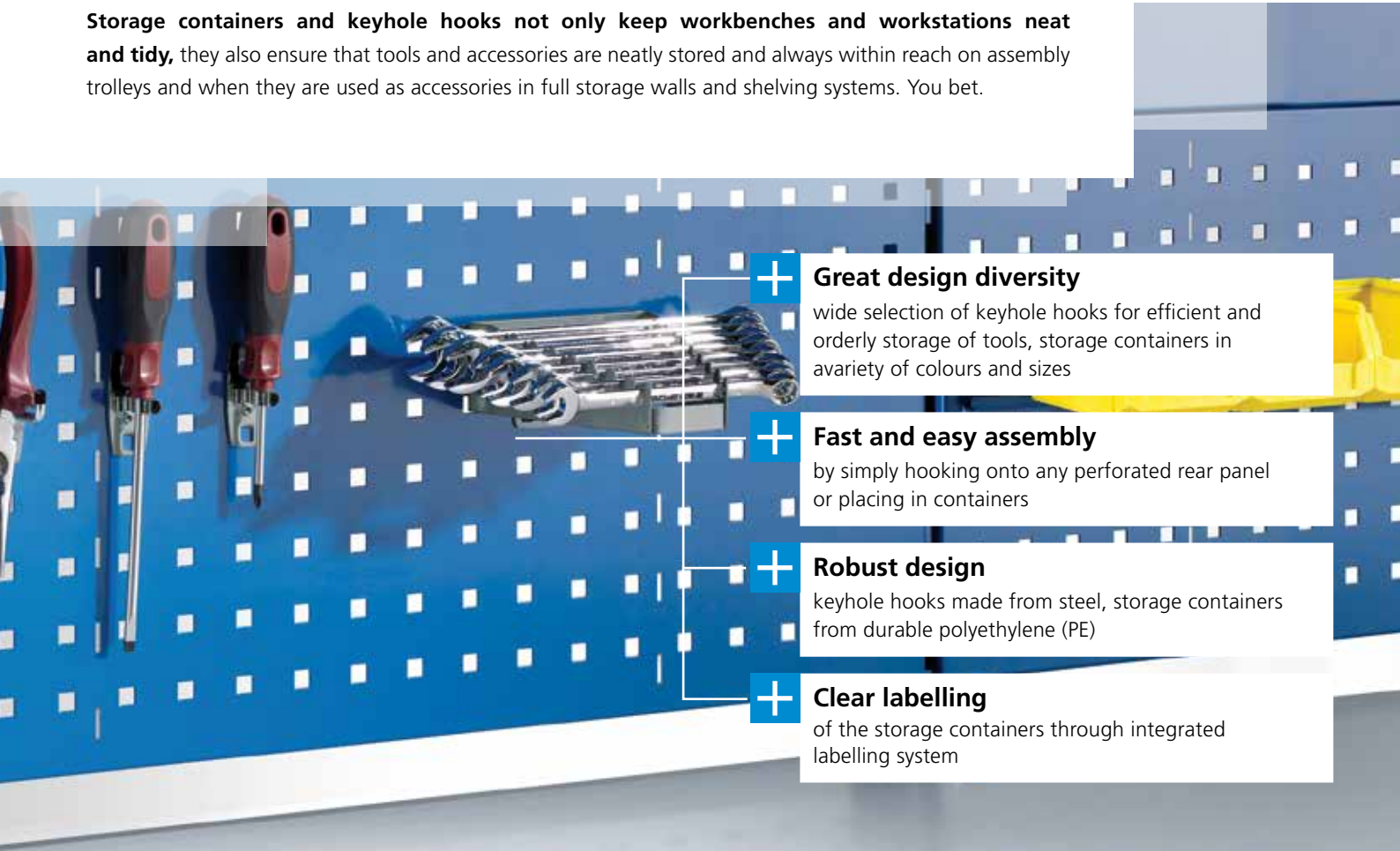

Storage containers and keyhole hooks not only keep workbenches and workstations neat and tidy, they also ensure that tools and accessories are neatly stored and always within reach on assembly trolleys and when they are used as accessories in full storage walls and shelving systems. You bet.



- + Great design diversity**  
wide selection of keyhole hooks for efficient and orderly storage of tools, storage containers in a variety of colours and sizes
- + Fast and easy assembly**  
by simply hooking onto any perforated rear panel or placing in containers
- + Robust design**  
keyhole hooks made from steel, storage containers from durable polyethylene (PE)
- + Clear labelling**  
of the storage containers through integrated labelling system

## Storage container

Width, depth and height refer to the external dimensions. The storage containers are resistant to most oils, acids and alkalis, reduce noise when used on conveyors and when used properly are resistant to temperatures of -20°C to +100°C. Specification: polypropylene.

						
	Size 2	Size 3	Size 4	Size 5Z	Size 5	Size 6
	Art. no.	Art. no.	Art. no.	Art. no.	Art. no.	Art. no.
	83.100.000	83.105.000	83.110.000	83.115.000	83.119.000	83.123.000
	83.101.000	83.106.000	83.111.000	83.116.000	83.120.000	83.124.000
	83.102.000	83.107.000	83.112.000	83.117.000	83.121.000	83.125.000
	83.103.000	83.108.000	83.113.000	83.118.000	83.122.000	83.126.000
Dimensions W × D × H mm	101 × 90 × 50	103 × 164 × 75	149 × 231 × 125	210 × 329 × 150	210 × 343 × 198	311 × 492 × 199
Content dm <sup>3</sup>	0.3	0.9	2.7	7.5	10.4	23.5
<b>Paper labels, white</b>	<b>83.127.000</b>	<b>83.129.000</b>	<b>83.131.000</b>	<b>83.131.000</b>	<b>83.131.000</b>	<b>83.131.000</b>
Number	10	10	10	10	10	10
<b>Transparent sheet</b>	<b>83.128.000</b>	<b>83.130.000</b>	<b>83.132.000</b>	<b>83.132.000</b>	<b>83.132.000</b>	<b>83.132.000</b>
Number	10	10	10	10	10	10

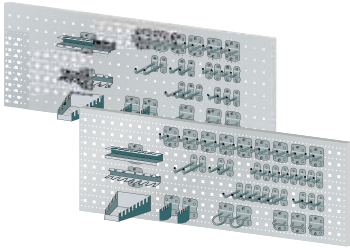

### Keyhole hook sets

Specification	Art. no.
12-piece	45.270.000
18-piece	45.271.000
28-piece	45.272.000
40-piece	45.273.000

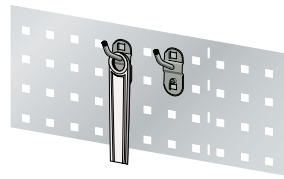

### Tool holder, inclined

Length mm	Art. no.
50	45.274.000
100	45.275.000
150	45.276.000

Sold in packs of 5

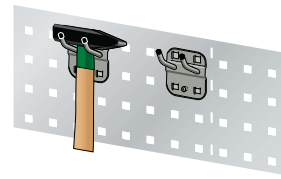

### Tool holder, inclined, double

Length mm	Art. no.
35	45.301.000
50	45.302.000
75	45.303.000

Sold in packs of 5

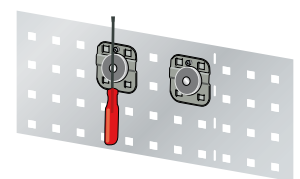

### Magnetic holder

Ø mm	Art. no.
35	44.345.000

Sold in packs of 5

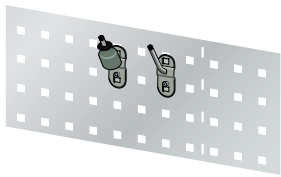

### Inclined hook

Length mm	Art. no.
14/40	45.277.000

Sold in packs of 5

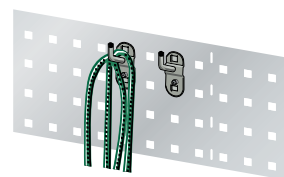

### Tool holder, vertical

Specification	Length mm	Art. no.
single	35	45.278.000
single	75	45.279.000
single	125	45.280.000

Sold in packs of 5

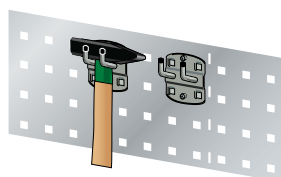

### Tool holder, vertical

Specification	Length mm	Art. no.
double	35	45.281.000
double	50	45.282.000
double	75	45.283.000

Sold in packs of 5

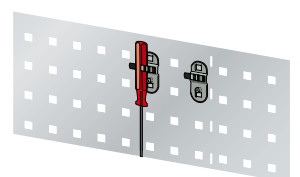

### Tool clamp

Ø mm	Art. no.
6	45.284.000
10	45.285.000
13	45.286.000
16	45.287.000
19	45.288.000

Sold in packs of 5

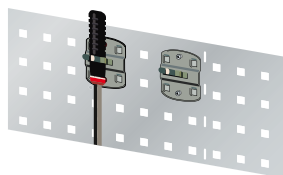

### Tool clamp, large base plate

Ø mm	Art. no.
25	45.289.000
28	45.290.000
32	45.291.000

Sold in packs of 5

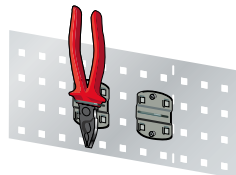

### Pliers holder

Width mm	Art. no.
35	45.292.000
55	45.293.000
75	45.294.000

Sold in packs of 5

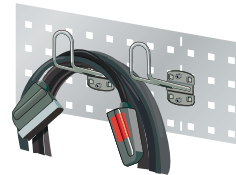

### Cable holder

Specification	Art. no.
150	45.295.000

Sold in packs of 5

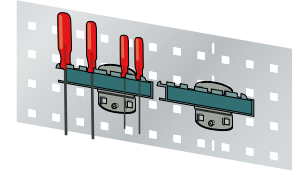

### Screwdriver holder

Specification	Art. no.
for 6 parts	45.296.000

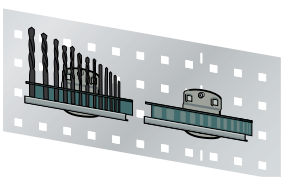

### Drill bit/Allen key holder

Specification	Art. no.
for 14 parts	45.297.000

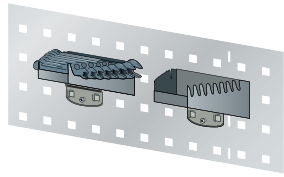

### Spanner holder

Specification	Art. no.
for 8 parts	45.298.000

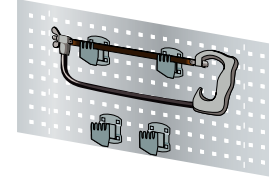

### Saw holder

Specification	Art. no.
for 4 saws	45.299.000

Sold in packs of 2

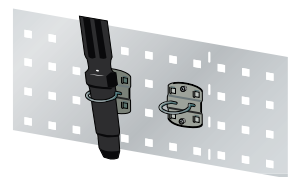

### Machine holder

Ø mm	Art. no.
40	45.300.000

Sold in packs of 5

The keyhole hooks must be fixed in position using the fixing tools provided. A detailed list of the keyhole hook sets is available on request. Further holders are available on request. Colour of holders: white aluminium, RAL 9006.

# Desk chairs







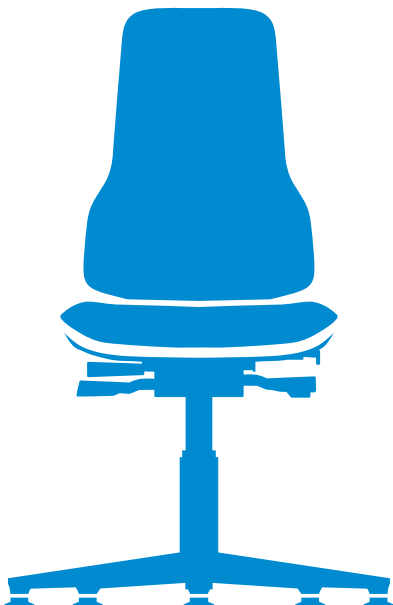

**Desk chairs from LISTA provide perfect seating and standing solutions for versatile use in production, at electronic workstations or in the laboratory.** All chairs are manufactured according to the industry work chair standard DIN 68877, taking into account all major ergonomic findings in industrial medicine. The robust design and hard-wearing materials make the chairs very durable, ensure the required hygiene and are easy to clean. With functions such as ergonomically adaptable adjustment, these chairs are the perfect workstation seating solution.

- + Utmost stability**  
Sturdy base with resilient, robust and non-slip seats
- + User-friendly and ergonomic**  
thanks to simple adjustment functions such as stepless seat and backrest height adjustment, seat tilt adjustment and weight regulation
- + Tremendous design diversity**  
thanks to different surfaces, materials and selectable bases with casters or abrasion-resistant sliders

**A good desk chair increases the efficiency of your company and ensures safety in the workplace**



-  free-floating backrest, height and tilt-adjustable
-  Adapts to different types of work when sitting
-  Prevents the risk of entrapment or crushing
-  height-adjustable seat
-  additional slip-resistant step-up rail for chairs with an adjustable seat height of over 650 mm
-  no casters for chairs with a seat height of over 650 mm (except for seat-stop casters)
-  Base with minimum five support points and safety against tilting



Art. no. **69.505.000**  
with casters, made of integral foam



Art. no. **69.500.000**  
with sliders, made of beech



Art. no. **69.509.000**  
with sliders and height-adjustable base ring, made of imitation leather

### Swivel chair

Perfect entry-level model for correct posture in production. Low profile, sturdy five-star base made of plastic, in black, either with load-dependent braked casters for hard floors or abrasion-resistant floor sliders. Available in the following versions: laminated beech, black Imitation leather and black integral foam.

	Surface	Integral foam	Beech	Imitation leather
Base including cushion	Seat height mm	Art. no.	Art. no.	Art. no.
<b>with casters</b>	440–620	<b>69.505.000</b>	<b>69.503.000</b>	<b>69.504.000</b>
<b>with sliders</b>	440–620	<b>69.502.000</b>	<b>69.500.000</b>	<b>69.501.000</b>
<b>With sliders and height-adjustable base ring</b>	580–850	<b>69.510.000</b>	<b>69.508.000</b>	<b>69.509.000</b>

### i Mechanisms and functions



Permanent contact backrest

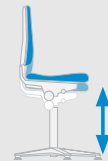

Seat height adjustment

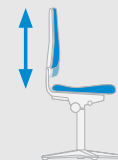

Backrest height adjustment



Art. no. **69.514.000**  
with casters, made of integral foam



Art. no. **69.513.000**  
with sliders, made of integral foam



Art. no. **69.515.000**  
with sliders and height-adjustable base ring, made of integral foam

### Swivel chair with Soft-Touch integral foam

Perfect industry chair providing optimum seating comfort thanks to the hard-wearing Soft-Touch integral foam. Easy to clean and resistant to all disinfectants. Low profile, sturdy five-star base made of plastic, in black, either with load-dependent braked casters for hard floors or abrasion-resistant floor sliders.

	Surface	Integral foam	Beech	Imitation leather
Base including cushion	Seat height mm	Art. no.	Art. no.	Art. no.
<b>with casters</b>	430–600	<b>69.514.000</b>	-	-
<b>with sliders</b>	430–600	<b>69.513.000</b>	-	-
<b>With sliders and height-adjustable base ring</b>	580–850	<b>69.515.000</b>	-	-

### i Mechanisms and functions



Permanent contact backrest

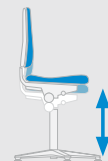

Seat height adjustment

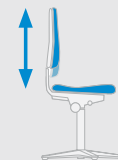

Backrest height adjustment



Seat tilt adjustment

# Desk chairs



Art. no. **69.518.000**  
with casters



Art. no. **69.516.000**  
with gliders



Art. no. **69.520.000**  
with gliders and footrest

## Swivel chair with replaceable cushion

Desk chair, ergonomic and functional for modern industry. Innovative chair/cushion combination in 1+1 system for durability, flexibility and perfect adaptation to the respective working area. Flexband made of soft plastic protects the chair and surrounding area, colour "Ocean blue". Solid steel construction with aluminium star base (metal parts in black, plastic parts in basalt grey), either with load-dependent braked casters for hard floors or abrasion-resistant floor gliders.

Base <b>excluding cushion</b>	Seat height mm	Art. no.
<b>with casters</b>	450–620	<b>69.518.000</b>
<b>with sliders</b>	450–620	<b>69.516.000</b>
<b>with gliders and footrest</b>	590–870	<b>69.520.000</b>

## Replacement cushions

A selection of cushion materials is available to suit a variety of applications: tough integral foam cushions capable of withstanding mechanical loads, soft and washable easy-care imitation leather, robust and breathable fabric cushions as well as the world first "Supertec" – an innovative cover material that combines the advantages of fabric and integral foam.



**Fabric**  
Breathable, comfortable, soft, hard-wearing. Colour: black.

Art. no. **69.522.000**



**Imitation leather**  
Washable, easy-care, resistant to oils and disinfectants, soft and comfortable. Colour: black.

Art. no. **69.523.000**



**Integral foam**  
Robust, durable, washable, resistant to flying sparks and weak acids and alkalis. Colour: black.

Art. no. **69.524.000**



**Supertec**  
Comfortable, soft, breathable, extremely hard-wearing, cut-resistant, non-slip, easy to clean. Colour: black.

Art. no. **69.525.000**

**i Mechanisms and functions**

Permanent contact backrest

Seat height adjustment

Seat tilt adjustment

Seat depth adjustment

Backrest height adjustment

Weight regulation



Art. no. **69.531.000**  
with casters,  
cover material made  
of integral foam

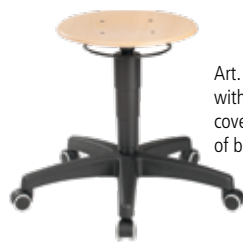

Art. no. **69.529.000**  
with casters,  
cover material made  
of beech



Art. no. **69.530.000**  
with casters,  
cover material made  
of imitation leather

### Swivel stool

Tough stool with extra large seat measuring 40 cm in diameter, ideal for trade and industry. The all-round cushion edge protection and sturdy steel star base guarantee a long lifetime. A practical gas spring release ring ensures convenient height adjustment. Sturdy five-star base made of steel in black. With load-dependent braked casters. Available in the following versions: black imitation leather, black integral foam and beech laminated wood.

	Surface	Integral foam	Beech	Imitation leather
Base including cushion	Seat height mm	Art. no.	Art. no.	Art. no.
<b>with casters</b>	460–630	<b>69.531.000</b>	<b>69.529.000</b>	<b>69.530.000</b>

#### i Mechanisms and functions

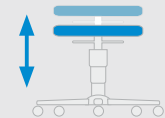

Seat height adjustment via gas spring with release ring



Art. no. **69.532.000**  
with casters,  
cover material made of  
integral foam

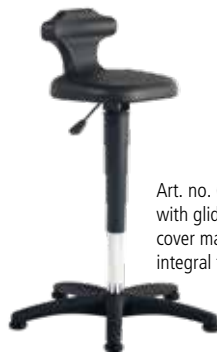

Art. no. **69.533.000**  
with gliders,  
cover material made of  
integral foam



Art. no. **69.534.000**  
with gliders and height-  
adjustable base ring,  
cover material made of  
integral foam

### Sitting/standing seat

Best support for sitting, standing and multi-purpose workstations. Secure seating thanks to ergonomic backrest and slip-resistant Wave seat. Extremely wear-resistant, soft cushion and good ventilation. Sturdy five-star base made of plastic in black. With optional load-dependent braked casters for hard floors or abrasion-resistant floor gliders, seat height adjustment and 360° rotatable seat.

	Surface	Integral foam	Beech	Imitation leather
Base including cushion	Seat height mm	Art. no.	Art. no.	Art. no.
<b>with casters</b>	430–600	<b>69.532.000</b>	-	-
<b>with sliders</b>	430–600	<b>69.533.000</b>	-	-
<b>With sliders and height-adjustable base ring</b>	510–780	<b>69.534.000</b>	-	-

#### i Mechanisms and functions

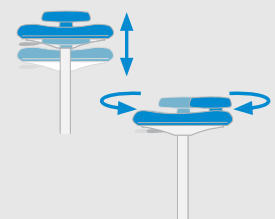

Seat height adjustment 360° rotatable seat

### Stand-up seat

Fascinating solution for virtually all kinds of standing work. Seat consists of hard-wearing and non-slip soft-touch PU foam (colour black), integrated comfort handles, extra wide comfortable seat, continuous seat height adjustment, seat rotatable 20° to the left and right, sturdy base with brilliant silver coated aluminium surface.

	Surface	Integral foam
Base including cushion	Seat height mm	Art. no.
<b>with base</b>	620–850	<b>69.535.000</b>

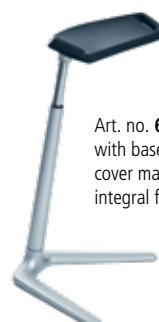

Art. no. **69.535.000**  
with base,  
cover material made of  
integral foam

#### i Mechanisms and functions

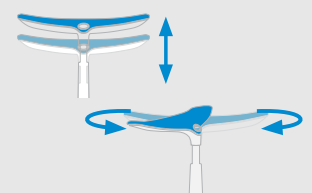

Seat height adjustment  
Seat rotatable 20°  
to the left and right

# THE PERFECT COMPLEMENT

**The extensive range of LISTA cabinets enables you to customise and add to your workspace and storage equipment.** The high-quality steel cabinets can be easily integrated into a variety of working environments and individually adapted to your specific requirements. They are suitable both for industrial purposes and for storing files and similar items in offices and administrative departments. And of course your personal belongings are always kept safe in a LISTA cabinet.





The right solution for every need



**Hinged door cabinets**  
see p. 170



**Sliding-door cabinets**  
see p. 178



**Wall-mounted cabinets with hinged or sliding doors**  
see p. 184

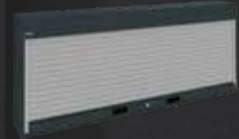

**Wall-mounted cabinets with roller shutter**  
see p. 186



**Roller shutter cabinets**  
see p. 188



**Vertical pull-out cabinets**  
see p. 190



**Heavy-duty cabinets**  
see p. 192



**Clothing lockers**  
see p. 196



**Compartment cabinets**  
see p. 202



**Battery charging cabinets**  
see p. 204



**Laptop cabinets and battery charging cabinets for electric scooters**  
see p. 210



**Battery charging cabinets as an e-bike charging station**  
see p. 214



**Environmental and oil cabinets**  
see p. 216



**Containers and large-scale pin cabinets\***



**Firefighter lockers\***

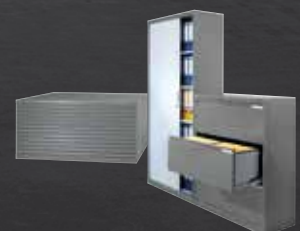

**Office cabinets\***

**LISTA hinged door cabinets provide secure and orderly storage for a variety of items.** All cabinets can be configured individually and adapted to your specific storage needs through the flexible use of partition materials and cabinet accessories.

### **!** ALWAYS WITH LISTA

#### **Choice of colours**







12 standard colours, all other colours available; see p. 22

#### **Intelligent locking systems**

Replaceable cylinders which can be fitted to existing locking systems, electronic locking systems via CODE and RFID Lock for absolute security made to measure; see p. 28

#### **Individual configuration options**

in size, equipment, locking system, colour and drawer partitions; see p. 10

- 
**Utmost stability**  
 with housing load capacity of up to 500 kg
- 
**High load capacities**  
 load capacity of 60 kg or 100 kg per adjustable shelf,  
 60 kg per drawer/pull-out shelf
- 
**Well protected**  
 protection from dirt, liquids and physical loads  
 thanks to closed housing with impact-resistant  
 and abrasion-resistant surface
- 
**Flexible configuration options**  
 with covers, perforated panels, suspension folder  
 pull-outs, desk mounts and clothes rails
- 
**Optimum order and organisation**  
 with optional installation of drawers and pull-out shelves  
 for clear and orderly storage of small parts (for a cabinet  
 depth of 580 mm)
- 
**Perfectly organised**  
 with viewing windows made from UV-resistant,  
 shatterproof acrylic
- 
**Secure locking**  
 with solid sheet or viewing window doors (flush-fitting,  
 folded from one piece) and intelligent locking systems
- 
**Can be adapted to new storage items at any time**  
 with the flexible integration and rearrangement of drawers,  
 pull-out shelves and adjustable shelves in increments of 25 mm

# Cabinet systems | Hinged door cabinets

## Hinged door cabinets

Depending on the model, the cabinets on these two pages are equipped with: adjustable shelves, galvanised, 30 mm thick, load capacity 60 kg. Pull-out shelves and drawers, painted, anthracite grey, RAL 7016, load capacity 60 kg. **Note: Cabinets with drawers and pull-out shelves come with floor anchoring as anti-tilting device.**



Art. no. **58.658.200**  
Anthracite grey, RAL 7016  
(excluding partition material)



Art. no. **62.203.030.C**  
Reseda green, RAL 6011

**H** ↑ 1000 mm

**W** → **D** ↗ Adjustable shelves Drawers Pull-out shelves Hinge pins mounted Art. no.

### Cabinets with 1 solid sheet door

500	400	1	-	-	60	Hinge	KEY Lock	<b>62.150.XXX</b>
500	500	1	-	-	60	Hinge	KEY Lock	<b>62.151.XXX</b>
500	580*	1	-	-	60	Hinge	KEY Lock	<b>58.280.XXX</b>



500	400	2	-	-	60	Hinge	KEY Lock	<b>62.152.XXX</b>
500	500	2	-	-	60	Hinge	KEY Lock	<b>62.153.XXX</b>
500	580*	2	-	-	60	Hinge	KEY Lock	<b>58.283.XXX</b>

500	580*	2	1×95	-	50/60	Hinge	KEY Lock	<b>58.652.XXX</b>
-----	------	---	------	---	-------	-------	----------	-------------------

### Cabinets with 2 solid sheet doors

1000	400	2	-	-	60	Hinge	KEY Lock	<b>60.460.XXX</b>
1000	500	2	-	-	60	Hinge	KEY Lock	<b>60.461.XXX</b>
1000	580*	2	-	-	60	Hinge	KEY Lock	<b>58.656.XXX</b>



1000	580*	2	1×95	-	50/60	Hinge	KEY Lock	<b>58.658.XXX</b>
------	------	---	------	---	-------	-------	----------	-------------------



### Hinged

- for the installation of drawers and pull-out shelves, doors must be fitted with hinges
- doors are flush with the cabinet housing
- opening angle approx. 115°



### Perfect storage

All hinged door cabinet drawers can be fitted individually with LISTA partition material to ensure the correct storage of small parts within the drawers.

**H** ↑ 1950 mm

**W** → **D** ↗ Adjustable shelves Drawers Pull-out shelves Hinge pins mounted Art. no.

### Cabinets with 2 solid sheet doors

750	500	4	-	-	60	Hinge	KEY Lock	<b>62.155.XXX</b>
750	580*	4	-	-	60	Hinge	KEY Lock	<b>62.156.XXX</b>



**i** When ordering a cabinet from these two pages with **CODE** or **RFID Lock**, please add the suffix **"C"** or **"F"**, respectively, to the article number stated in the table (e.g. **62.201.XXX.C**).





Art. no. **58.665.010**  
Light blue, RAL 5012



**H** **1950 mm**



**W** **D** Adjustable shelves Drawers Pull-out shelves Hinge pins mounted Art. no.

**Cabinets with 2 solid sheet doors**

1000	400	4	-	-	60	Hinge	KEY Lock	<b>60.418.XXX</b>
1000	500	4	-	-	60	Hinge	KEY Lock	<b>60.419.XXX</b>
1000	580*	4	-	-	60	Hinge	KEY Lock	<b>58.617.XXX</b>
1250	400	4	-	-	60	Hinge	KEY Lock	<b>60.420.XXX</b>
1250	500	4	-	-	60	Hinge	KEY Lock	<b>60.421.XXX</b>
1250	580*	4	-	-	60	Hinge	KEY Lock	<b>60.471.XXX</b>
1000	580*	2	3 × 95	2	50/60	Hinge	KEY Lock	<b>58.665.XXX</b>
1000	580*	2	-	4	50/60	Hinge	KEY Lock	<b>58.662.XXX</b>

**Cabinets with 2 viewing window doors**

1000	400	4	-	-	60	Hinge	KEY Lock	<b>62.201.XXX</b>
1000	500	4	-	-	60	Hinge	KEY Lock	<b>62.202.XXX</b>
1000	580*	4	-	-	60	Hinge	KEY Lock	<b>60.333.XXX</b>
1250	400	4	-	-	60	Hinge	KEY Lock	<b>60.583.XXX</b>
1250	500	4	-	-	60	Hinge	KEY Lock	<b>60.584.XXX</b>
1250	580*	4	-	-	60	Hinge	KEY Lock	<b>60.585.XXX</b>
1000	580*	2	3 × 95	2	50/60	Hinge	KEY Lock	<b>60.417.XXX</b>
1000	580*	2	-	4	50/60	Hinge	KEY Lock	<b>60.335.XXX</b>

\* Retrofitting with drawers and pull-out shelves possible.



**Individual arrangements**

- with adjustable shelves, drawers and pull-out shelves
- covers, perforated panels, suspension folder pull-outs, desk mounts and clothes rails are available as optional extras



**Hinged doors with viewing windows**

- for greater transparency of stored items
- encourages order



# Cabinet systems | Hinged door cabinets



Art. no. **58.445.070**  
Ruby red, RAL 3003  
(excluding partition material)



Art. no. **60.472.050**  
Metallic grey, NCS S 6502-B

## H ↑ 1950 mm, with partition



W → D ↗ Adjustable shelves Drawers Pull-out shelves Hinge pins mounted Art. no.

### Cabinets with 2 solid sheet doors and partition

1000	500	10	-	-	60	Hinge	KEY Lock	<b>60.614.XXX</b>
1000	580	10	-	-	60	Hinge	KEY Lock	<b>60.615.XXX</b>
1000	580*	6	6×95	2	50/60	Hinge	KEY Lock	<b>58.445.XXX</b>



### Cabinets with 2 viewing window doors and partition

1000	500	10	-	-	60	Hinge	KEY Lock	<b>60.621.XXX</b>
1000	580*	10	-	-	60	Hinge	KEY Lock	<b>60.622.XXX</b>
1000	580*	6	6×95	2	50/60	Hinge	KEY Lock	<b>60.602.XXX</b>

\* Retrofitting with drawers and pull-out shelves possible.



### Perfect storage

All hinged door cabinet drawers can be fitted individually with LISTA partition material to ensure the correct storage of small parts within the drawers.

## H ↑ 1950 mm, with partition and clothes storage



W → D ↗ Clothes storage equipment Hinge pins mounted Art. no.

### Cabinets with 2 solid sheet doors, partition and clothes storage

1000	500	1 adjustable shelf usable width 982 mm, 3 adjustable shelves usable width 481 mm, 1 clothes rail with 3 plastic hooks	60	Hinge	KEY Lock	<b>60.472.XXX</b>
------	-----	---	----	-------	----------	-------------------



### Cabinets with 2 viewing window doors, partition and clothes storage

1000	500	1 adjustable shelf usable width 982 mm, 3 adjustable shelves usable width 481 mm, 1 clothes rail with 3 plastic hooks	60	Hinge	KEY Lock	<b>60.611.XXX</b>
------	-----	---	----	-------	----------	-------------------

**i** When ordering a cabinet from these two pages with **CODE** or **RFID Lock**, please add the suffix **"C"** or **"F"**, respectively, to the article number stated in the table (e.g. **62.201.XXX.C**).





**Slotted adjustable shelves**  
Adjustable shelves including 4 shelf supports. Specification: steel sheet, galvanised, slotted. Long sides folded by 4 × 90°. 30 mm thick with load-bearing capacity of 60 or 100 kg.

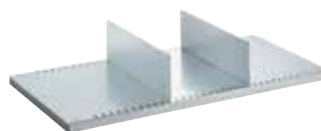

**Dividers for adjustable shelves**  
For subdividing adjustable shelves. Specification: steel sheet, painted. Colour: light grey, RAL 7035.



**Drawers and pull-out shelves**  
Full extension with ball bearings, including guide rails. Load capacity 60 kg. Specification: steel sheet. Colour: anthracite grey, RAL 7016. **Only compatible with cabinets with hinges and a depth of 580 mm.**

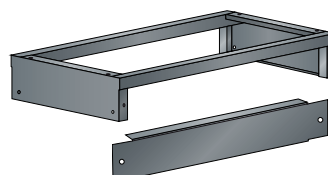

**Base**  
Robust steel tubing construction 40 × 40 mm, closed side panels, incl. fastening material (screw connection between cabinet and base). Optional: base cover to be attached as a cover on the front or rear. Colour: Anthracite grey, RAL 7016.

» Please contact us for the complete range of accessories.

		W → For cabinet width mm		500	750	1000	1000	1250
		D ↗ For cabinet depth mm		Art. no.	Art. no.	Art. no.	Art. no.	Art. no.
<b>Adjustable shelf</b>			Load capacity kg				with central partition	
400		60		58.100.000	58.103.000	58.106.000	58.100.000	58.109.000
400		100		-	-	60.487.000	-	60.488.000
500		60		58.101.000	58.104.000	58.107.000	58.101.000	58.110.000
500		100		-	-	60.407.000	-	60.408.000
580		60		58.102.000	58.105.000	58.108.000	58.102.000	58.111.000
580		100		-	-	60.409.000	-	60.434.000
		Usable dimensions (W × D mm)		480 × 326/426/506	730 × 326/426/506	980 × 326/426/506	480 × 326/426/506	1230 × 326/426/506
<b>Divider for adjustable shelf</b>								
400	L 311 × H 150 mm			58.144.000	58.144.000	58.144.000	58.144.000	58.144.000
500	L 411 × H 150 mm			58.145.000	58.145.000	58.145.000	58.145.000	58.145.000
580	L 490 × H 150 mm			58.146.000	58.146.000	58.146.000	58.146.000	58.146.000
<b>Drawer</b>		H ↑	Usable height mm					
580	95	72		62.141.000	62.308.000	58.113.000	62.141.000	57.481.000
580	145	122		-	-	57.471.000	-	57.482.000
		Usable dimensions (W × D mm)		357 × 459	617 × 459	867 × 459	357 × 459	1117 × 459
<b>Pull-out shelf</b>		H ↑	Usable height mm					
580	53	43		62.142.000	-	58.115.000	62.142.000	-
		Usable dimensions (W × D mm)		357 × 459		867 × 459	357 × 459	
<b>Base*</b>		H ↑						
500	150			-	97.844.000	98.518.000	98.518.000	98.253.000
580	150			-	98.657.000	98.216.000	98.216.000	97.835.000
<b>Base cover, H 150 mm</b>				-	57.238.000	97.986.000	97.986.000	62.806.000

**Screw connections**

Hinged door cabinets (for housing height 1000 mm) are designed to allow a second cabinet to be screwed on (one on top of the other). **98.501.000**



## Partition material sets for drawers

**W → for 500 mm**

 357 × 459 mm

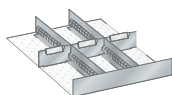

### Slotted dividers and metal separators

For front height mm      Art. no.

**95**      **62.159.000**

1 slotted partition:      21 E on one side  
2 slotted dividers:      27 E  
3 metal separators:      7 E

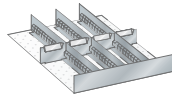

### Slotted dividers and metal separators

For front height mm      Art. no.

**95**      **62.160.000**

1 slotted partition:      21 E on one side  
3 slotted dividers:      27 E  
3 metal separators:      5 E  
1 metal separator:      6 E

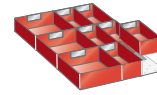

### Plastic boxes

For front height mm      Art. no.

**95**      **62.161.000**

3 plastic boxes:      150 × 150 × 71 mm  
6 plastic boxes:      150 × 75 × 71 mm  
1 spacer angle

**W → for 1000 mm**

 867 × 459 mm

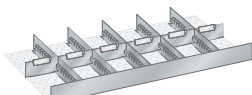

### Slotted dividers and metal separators

For front height mm      Art. no.

**95**      **58.477.000**

**145**      **61.163.000**

1 slotted partition:      51 E on one side  
5 slotted dividers:      27 E  
6 metal separators:      4 × 8 E, 1 × 9 E, 1 × 10 E

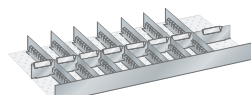

### Slotted dividers and metal separators

For front height mm      Art. no.

**95**      **58.478.000**

**145**      **61.164.000**

1 slotted partition:      51 E on one side  
7 slotted dividers:      27 E  
8 metal separators:      7 × 6 E, 1 × 9 E

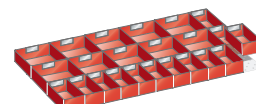

### Plastic boxes

For front height mm      Art. no.

**95**      **58.491.000**

10 plastic boxes:      150 × 150 × 71 mm  
13 plastic boxes:      150 × 75 × 71 mm  
1 spacer angle

**W → for 1250 mm**

 1117 × 459 mm

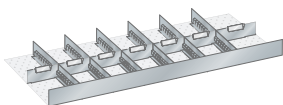

### Slotted dividers and metal separators

For front height mm      Art. no.

**95**      **61.165.000**

**145**      **61.186.000**

1 slotted partition:      65 E on one side  
6 slotted dividers:      27 E  
7 metal separators:      6 × 9 E, 1 × 10 E

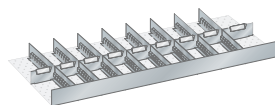

### Slotted dividers and metal separators

For front height mm      Art. no.

**95**      **61.166.000**

**145**      **61.187.000**

1 slotted partition:      65 E on one side  
8 slotted dividers:      27 E  
9 metal separators:      8 × 7 E, 1 × 9 E



Light blue, RAL 5012  
(excluding partition material)

**i** **Suitable labels for partition material**  
The practical clip-on label holders are fitted directly onto the metal separators.

**»»** Labelling system see p. 268



**Note:** the front height corresponds to the drawer front height. For the actual height of the partition material see p. 262–265. Partition material sets excluding clip-on label holder.





### Cabinet housing

The housings of the hinged door cabinets are made from high-quality sheet steel and are available with specifications for one or two hinged doors, with or without a fixed partition. The inside fittings of the cabinet are easy to customize thanks to the 25:25 mm divisions.



### Hinged doors

The hinged doors in solid sheet or with a viewing window are folded from one piece, flush-fitting and flush with the cabinet housing. The doors can be equipped with hinges, with an opening angle of approx. 115°. The hinged doors can be equipped with a KEY Lock, a CODE Lock or an RFID Lock as desired.

W → For cabinet width mm	500	750	1000	1000 with central partition	1250
--------------------------	-----	-----	------	--------------------------------	------

#### Cabinet housing

H ↑	Clear height	D ↗	Art. no.	Art. no.	Art. no.	Art. no.	Art. no.
1000	885	400	<b>57.600.XXX</b>	-	<b>57.612.XXX</b>	-	-
		500	<b>57.601.XXX</b>	-	<b>57.613.XXX</b>	-	-
		580	<b>57.602.XXX</b>	-	<b>57.614.XXX</b>	<b>58.431.XXX</b>	-
1950	1835	400	-	<b>57.609.XXX</b>	<b>57.618.XXX</b>	-	<b>57.627.XXX</b>
		500	-	<b>57.693.XXX</b>	<b>57.619.XXX</b>	-	<b>57.628.XXX</b>
		580	-	<b>57.611.XXX</b>	<b>57.620.XXX</b>	<b>58.433.XXX</b>	<b>57.629.XXX</b>

#### Hinged doors excl. clasp lock

H ↑	Door design	Art. no.	Art. no.	Art. no.	Art. no.	Art. no.
1000	Solid sheet	<b>62.003.XXX</b>	-	<b>62.009.XXX</b>	<b>62.009.XXX</b>	-
	Viewing window	<b>62.307.XXX</b>	-	<b>62.137.XXX</b>	<b>62.137.XXX</b>	-
1950	Solid sheet	-	<b>62.006.XXX</b>	<b>62.011.XXX</b>	<b>62.011.XXX</b>	<b>62.016.XXX</b>
	Viewing window	-	-	<b>62.012.XXX</b>	<b>62.012.XXX</b>	<b>62.017.XXX</b>

#### + clasp lock

<b>KEY Lock separately lockable</b>	<b>49.060.000</b>	<b>49.060.000</b>	<b>49.060.000</b>	<b>49.060.000</b>	<b>49.060.000</b>
<b>CODE Lock</b>	<b>49.085.000</b>	<b>49.085.000</b>	<b>49.085.000</b>	<b>49.085.000</b>	<b>49.085.000</b>
<b>RFID Lock</b>	<b>49.086.000</b>	<b>49.086.000</b>	<b>49.086.000</b>	<b>49.086.000</b>	<b>49.086.000</b>



**i**

### Clasp locks

The standard KEY Lock locking system with replaceable cylinders makes it easy to adapt to existing locking systems. With CODE Lock, the key is replaced by a simple numeric combination. The LISTA RFID Lock enables automatic and contactless locking through radio frequency identification.



**When space is limited, sliding-door cabinets from LISTA are the ideal solution for your storage items.** Because the smooth-running doors remain in the housing and do not jut out into the traffic area.



### **Utmost stability**

thanks to housing with a load capacity of 500 to 950 kg (as from a width of 1500 mm)



### **Perfectly smooth running**

since the sliding doors are equipped with high-quality, smooth-running and quiet runners



### **Benefits of LISTA cabinet systems**

see p. 168



# Cabinet systems | Sliding-door cabinets with solid sheet doors



Art. no. **58.765.010**  
Light blue, RAL 5012

**H** ↑ 1000 mm

**W** → **D** ↗ Adjustable shelves Drawers Pull-out shelves **kg** **kg** Art. no.

### Cabinets with 2 solid sheet doors



1000	400	2	-	-	60	KEY Lock	<b>58.747.XXX</b>
1000	500	2	-	-	60	KEY Lock	<b>58.756.XXX</b>
1000	580	2	-	-	60	KEY Lock	<b>58.757.XXX</b>



1250	400	2	-	-	60	KEY Lock	<b>58.758.XXX</b>
1250	500	2	-	-	60	KEY Lock	<b>58.759.XXX</b>
1250	580	2	-	-	60	KEY Lock	<b>58.760.XXX</b>



Art. no. **58.757.060**  
Black, NCS S 9000-N

### Cabinets with 2 solid sheet doors and partition



1500	400	4	-	-	60	KEY Lock	<b>58.761.XXX</b>
1500	500	4	-	-	60	KEY Lock	<b>58.762.XXX</b>
1500	580*	4	-	-	60	KEY Lock	<b>58.763.XXX</b>



2000	400	4	-	-	60	KEY Lock	<b>58.796.XXX</b>
2000	500	4	-	-	60	KEY Lock	<b>58.764.XXX</b>
2000	580*	4	-	-	60	KEY Lock	<b>58.765.XXX</b>
2000	580*	2	2 × 95	4	50/60	KEY Lock	<b>58.745.XXX</b>



**Sliding-door cabinets**  
Depending on the model, the cabinets on these two pages are fitted with: adjustable shelves, galvanised, 30 mm thick, load capacity 60 kg, pull-out shelves and drawers, painted, anthracite grey, RAL 7016, load capacity 50 kg



**H** ↑ 1950 mm

Art. no. **58.750.020**  
Light grey, RAL 7035

**W** → **D** ↗ Adjustable shelves Drawers Pull-out shelves Art. no.

**Cabinets with 2 solid sheet doors**

1000	400	4	-	-	60	KEY Lock	<b>58.748.XXX</b>
1000	500	4	-	-	60	KEY Lock	<b>58.749.XXX</b>
1000	580	4	-	-	60	KEY Lock	<b>58.750.XXX</b>

1250	400	4	-	-	60	KEY Lock	<b>58.777.XXX</b>
1250	500	4	-	-	60	KEY Lock	<b>58.778.XXX</b>
1250	580	4	-	-	60	KEY Lock	<b>58.779.XXX</b>

**Cabinets with 2 solid sheet doors and partition**

1000	580*	8	-	-	60	KEY Lock	<b>58.751.XXX</b>
1500	400	8	-	-	60	KEY Lock	<b>58.780.XXX</b>
1500	500	8	-	-	60	KEY Lock	<b>58.781.XXX</b>
1500	580*	8	-	-	60	KEY Lock	<b>58.782.XXX</b>

2000	400	8	-	-	60	KEY Lock	<b>58.783.XXX</b>
2000	500	8	-	-	60	KEY Lock	<b>58.784.XXX</b>
2000	580*	8	-	-	60	KEY Lock	<b>58.754.XXX</b>
2000	580*	4	-	4	50/60	KEY Lock	<b>58.755.XXX</b>



**Lock-down cylinder lock / KEY Lock**

The doors cannot be prised out thanks to the right-angled bar used in the locking system.



**Extremely smooth running**

The ball bearing rollers of the sliding doors run quietly on the guide rails.



# Cabinet systems | Sliding-door cabinets with viewing window doors



Art. no. **60.720.070**  
Ruby red, RAL 3003

**H** ↑ 1000 mm

**W** → **D** ↗ Adjustable shelves Drawers Pull-out shelves Art. no.

### Cabinets with 2 viewing window doors and partition

1500	400	4	-	-	60	KEY Lock	<b>60.715.XXX</b>
1500	500	4	-	-	60	KEY Lock	<b>60.716.XXX</b>
1500	580*	4	-	-	60	KEY Lock	<b>60.717.XXX</b>
2000	400	4	-	-	60	KEY Lock	<b>60.721.XXX</b>
2000	500	4	-	-	60	KEY Lock	<b>60.722.XXX</b>
2000	580*	4	-	-	60	KEY Lock	<b>60.723.XXX</b>
2000	580*	2	2×95	4	50/60	KEY Lock	<b>60.725.XXX</b>



### Sliding doors with viewing windows

The UV-resistant acrylic glass is shatterproof and enables clear organisation at the workstation.

**H** ↑ 1950 mm

**W** → **D** ↗ Adjustable shelves Drawers Pull-out shelves Art. no.

### Cabinets with 2 viewing window doors and partition

1500	400	8	-	-	60	KEY Lock	<b>60.718.XXX</b>
1500	500	8	-	-	60	KEY Lock	<b>60.719.XXX</b>
1500	580	8	-	-	60	KEY Lock	<b>60.720.XXX</b>
2000	400	8	-	-	60	KEY Lock	<b>60.726.XXX</b>
2000	500	8	-	-	60	KEY Lock	<b>60.727.XXX</b>
2000	580*	8	-	-	60	KEY Lock	<b>60.728.XXX</b>
2000	580*	4	-	4	50/60	KEY Lock	<b>60.729.XXX</b>



### Sliding-door cabinets

Depending on the model, the cabinets on these two pages are fitted with: adjustable shelves, galvanised, 30 mm thick, load capacity 60 kg, pull-out shelves and drawers, painted, anthracite grey, RAL 7016, load capacity 50 kg



**Slotted adjustable shelves**  
Adjustable shelves including 4 shelf supports. Specification: steel sheet, galvanised, slotted. Long sides folded by 4 × 90°. 30 mm thick with load-bearing capacity of 60 or 100 kg.

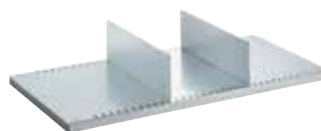

**Dividers for adjustable shelves**  
For subdividing adjustable shelves. Specification: steel sheet, painted. Colour: light grey, RAL 7035.



**Drawers and pull-out shelves**  
Full extension with ball bearings, including guide rails. Load capacity 50 kg. Specification: steel sheet. Colour: anthracite grey, RAL 7016. **For cabinet depth 580 mm.**

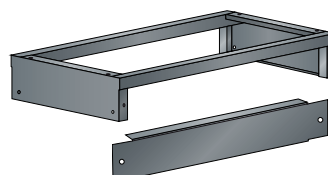

**Base**  
Robust steel tubing construction 40 × 40 mm, closed side panels, incl. fastening material (screw connection between cabinet and base). Optional: base cover to be attached as a cover on the front or rear. Colour: Anthracite grey, RAL 7016.

		<b>W</b> → For cabinet width mm		1000	1000	1250	1500	2000
					with central partition		with central partition	with central partition
<b>D</b> ↗ For cabinet depth mm	Load capacity kg	Art. no.	Art. no.	Art. no.	Art. no.	Art. no.	Art. no.	Art. no.
<b>Adjustable shelf</b>								
400	60	58.106.000	58.100.000	58.109.000	58.103.000	58.106.000		
400	100	60.487.000	-	60.488.000	-	60.487.000		
500	60	58.107.000	58.101.000	58.110.000	58.104.000	58.107.000		
500	100	60.407.000	-	60.408.000	-	60.407.000		
580	60	58.108.000	58.102.000	58.111.000	58.105.000	58.108.000		
580	100	60.409.000	-	60.434.000	-	60.409.000		
Usable dimensions (W × D mm)		980 × 326/426/506	480 × 326/426/506	1230 × 326/426/506	730 × 326/426/506	980 × 326/426/506		
<b>Divider for adjustable shelf</b>								
400	L 311 × H 150 mm	58.144.000	58.144.000	58.144.000	58.144.000	58.144.000		
500	L 411 × H 150 mm	58.145.000	58.145.000	58.145.000	58.145.000	58.145.000		
580	L 490 × H 150 mm	58.146.000	58.146.000	58.146.000	58.146.000	58.146.000		
<b>Drawer</b>								
	<b>H</b> ↑ Usable height mm							
580	95	72	58.113.000	62.141.000	-	62.308.000	58.113.000	
580	145	122	57.471.000	-	-	-	57.471.000	
Usable dimensions (W × D mm)			867 × 459	357 × 459		617 × 459	867 × 459	
<b>Pull-out shelf</b>								
	<b>H</b> ↑ Usable height mm							
580	53	43	58.115.000	62.142.000	-	-	58.115.000	
Usable dimensions (W × D mm)			867 × 459	357 × 459			867 × 459	
<b>Base</b>								
	<b>H</b> ↑							
500	150		98.518.000	98.518.000	98.253.000	57.277.000	97.103.000	
580	150		98.216.000	98.216.000	97.835.000	97.457.000	97.133.000	
<b>Base cover, H 150 mm</b>			97.986.000	97.986.000	62.806.000	57.239.000	98.259.000	

» Partition material see p. 176

» Please contact us for the complete range of accessories.

\* Floor anchoring may be required, depending on the version.



## Cabinet systems | Wall-mounted cabinets with hinged or sliding doors



**+ Utmost stability**  
thanks to housing with load capacity of 40 to 80 kg

**+ Optimum order and organisation**  
thanks to adjustable shelves with load capacities of up to 40 kg for neat and tidy storage of tools, files and other equipment

**+ User-friendly**  
since the stored items are easy to reach and at viewing height

**+ Perfect cable management**  
with cable openings and intermediate shelf for tidy and well-protected cable routing

**+ Flexible configuration options**  
thanks to pre-perforated holes (punch-outs) as cable guide for power strips and LED lights

**>> Benefits of LISTA cabinet systems**  
see p. 168

**LISTA wall-mounted cabinets are perfect as additional storage space for small parts, documents and more.** They keep your storage items ergonomically and conveniently stored at viewing height. Just mount them on the wall and in no time everything is just where it should be: neatly put away.





Art. no. **69.861.200**  
Wall-mounted cabinets with sliding doors,  
height 420 mm, RAL 7016



Art. no. **69.865.200**  
Wall-mounted cabinets with sliding doors,  
height 800 mm, RAL 7016

### Wall-mounted cabinets

Flush-fitting hinged doors with reinforced edges for increased rigidity, with fulcrum pins, 110 ° opening angle. Sliding doors edged from one piece, low-noise ball-bearing-mounted sliding door guide. Housing incl. punch-outs for power supply to the cabinets. Adjustable shelving (adjustable grid 25 mm) cable compartments under each shelf are optionally available. Base height: 35 mm.

**H** **420 mm** Clear height 350 mm



		Specification		Door storage/ door guide		Art. no.
<b>1000</b>	<b>350</b>	Punch-outs Optional: Adjustable shelf	<b>40</b>	pin hinge	KEY Lock	<b>69.860.XXX</b>



		Specification		Door storage/ door guide		Art. no.
<b>1000</b>	<b>350</b>	Punch-outs Optional: Adjustable shelf	<b>40</b>	ball bearing	KEY Lock	<b>69.861.XXX</b>

**H** **800 mm** Clear height 730 mm



		Specification		Door storage/ door guide		Art. no.
<b>1000</b>	<b>350</b>	Punch-outs 1 adjustable shelf	<b>40/80</b>	pin hinge	KEY Lock	<b>69.865.XXX</b>



		Specification		Door storage/ door guide		Art. no.
<b>1000</b>	<b>350</b>	Punch-outs 1 adjustable shelf	<b>40/80</b>	ball bearing	KEY Lock	<b>69.866.XXX</b>



#### Adjustable shelf for wall-mounted cabinet

Width: 1000 mm.  
Load capacity: 40 kg.

Art. no. **69.883.XXX**



#### Cover flap set

Custom-fit flap and cable collar for punch-outs.  
Delivery: 2 hinged flaps.  
1 cable collar

Art. no. **69.869.000**

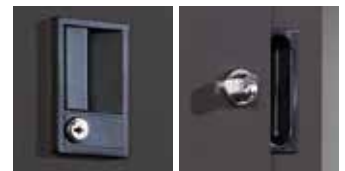

#### Clasp lock KEY Lock

- standard locking system for hinged doors with replaceable cylinders
- makes it easy to adapt to existing locking systems

#### Lock-down cylinder lock / KEY Lock

- locking system for sliding doors
- cannot be prised out thanks to the right-angled bar



#### Extremely smooth running

- the ball bearing rollers of the sliding doors run quietly on the guide rails



#### Cable feed-through

- punch-outs allow the cabinet to be provided with a power supply, see p. 147
- punch-outs are present on the lid and base
- there is space for cable routing underneath the shelf





**+ Flexible configuration and organisation**  
thanks to perforated and slotted rear panels, individually configurable with optional adjustable shelves or integrated cable conduit

**+ User-friendly operation**  
Aluminium roller shutters with spring-loaded coils: self-locking, effortless operation. Optimum use of space with a continuous usable depth of 215 mm

**+ Versatile**  
also available as top-mounted cabinet without a base for direct mounting onto the worktop, see p. 121

**>> Benefits of LISTA cabinet systems**  
see p. 168

**LISTA wall-mounted shutter cabinet for optimal tool storage.** The cabinet can be custom-adapted to your needs with optional accessories such as an adjustable shelf or power conduit.

### Wall-mounted cabinet with aluminium roller shutters

This type of cabinet is ideal for securely hanging tools. The space-saving roller shutter winder gives a maximum usable depth of 215 mm and also allows the use of standard folders. In addition, this cabinet can optionally be equipped with an integrated cable conduit to accommodate the energy modules (see p. 145). For direct fastening to the work-top, this cabinet (1050 mm high) can also be ordered without a floor (see p. 121).



Art. no. **69.851.200**  
Wall-mounted cabinet with aluminium roller shutters, RAL 7016

### Roller shutter cabinet

Aluminium roller shutter with spring-loaded winding ensures a large usable depth (215 mm) and safe operation (self-locking). The sturdy steel housing and the aluminium roller shutters ensure stable, secure storage. Punch-outs intended for power supply. Perforated rear panel for using perforated wall hooks (see p. 163), with square perforation 10 x 10 and 38 mm divisions.

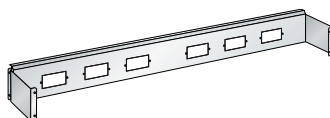
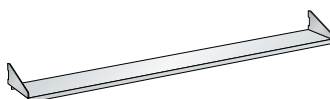
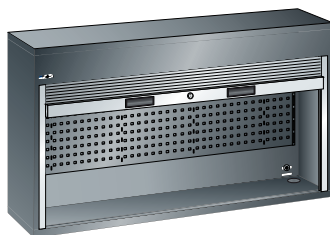

Model	Fastening	W →	D ↗	H ↑	Art. no.
with floor	on support pillar via perforated rear panel	1500	250	800	<b>69.850.XXX</b>
with floor	on support pillar via perforated rear panel	2000	250	800	<b>69.851.XXX</b>

	W →	D ↗	kg	Art. no.
<b>Adjustable shelf</b>	1500	175	20	<b>69.854.XXX</b>
optional	2000	175	20	<b>69.855.XXX</b>

	for W →	for power modules	Art. no.
<b>Power conduit set</b>	1500	6 ×	<b>89.022.XXX</b>
	2000	8 ×	<b>89.023.XXX</b>

Integrated cable conduit solution. Designed for installation in roller shutter cabinet. The power conduit can be equipped with the power modules. see page 145



#### Housing

- Sturdy steel structure
- Version with shelf as an overhead cabinet or alternatively without a shelf as an top-mounted cabinet, see p. 121



#### Handle

- Integrated handle
- Locking mechanism has no impact on usable depth
- Locking with KEY lock, keyed alike option also possible on request

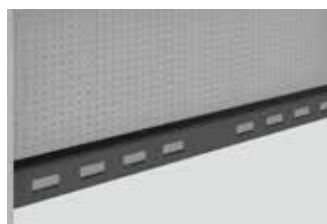

#### Power conduit

- Optionally integrated power conduit
- Configurable with power modules (see page 144)

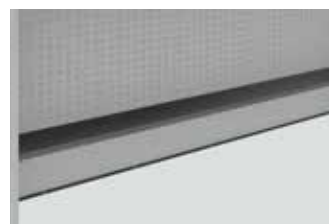

#### Adjustable shelf

- Optional adjustable shelf
- Adjustment increment: 25 mm

## Cabinet systems | Roller shutter cabinets

**LISTA roller shutter cabinets give you full access to your stored items even in confined spaces.** And the individual configuration and equipment options mean that they are right for a wide variety of workplaces from workshop to office.

### + Utmost stability

with housing load capacity of up to 500 kg

### + Secure locking

thanks to the smooth-running roller shutters with user-friendly push handle and integrated cylinder lock with replaceable cylinders (other locking systems on request)

### + User-friendly

roller shutter stops at any height without the need for catches

### >> Benefits of LISTA cabinet systems

see p. 168



**Roller shutter cabinets**

Depending on the model, the cabinets on this page are fitted with: adjustable shelves, galvanised, 30 mm thick, load capacity 60 or 100 kg, pull-out shelves and drawers, painted, anthracite grey, RAL 7016, load capacity 50 kg, roller shutter in PVC, colour similar to light grey, RAL 7035



**Direct access to all stored items**

The smooth-running roller shutter which can be operated with one hand stops at any height without the need for catches.

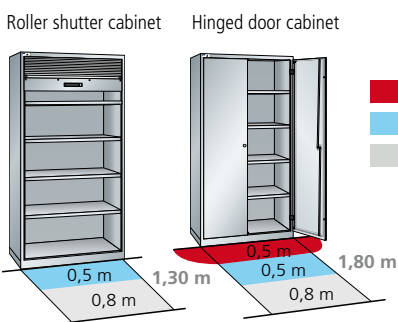

Art. no. **58.401.010**  
Light blue, RAL 5012



**Strike plate**

The sturdy metal strike plate comes with an anti-trap finger guard for safety reasons.



H ↑ 1950 mm		W → 1000 mm		D ↗ 580 mm*	
Adjustable shelves	Drawers	Pull-out shelves	kg	Lock	Art. no.
4	-	-	60	KEY Lock	<b>58.401.XXX</b>
2	-	2	50/60	KEY Lock	<b>58.402.XXX</b>
2	1 × 95	2	50/60	KEY Lock	<b>58.404.XXX</b>
2	-	4	50/60	KEY Lock	<b>58.403.XXX</b>
2	2 × 95	3	50/60	KEY Lock	<b>58.406.XXX</b>
2	1 × 95	4	50/60	KEY Lock	<b>58.405.XXX</b>

\* Retrofitting with drawers and pull-out shelves possible.



**Push handle cylinder lock/ KEY Lock**

The replaceable cylinder makes it possible to adapt the locking system as required.

**Slotted adjustable shelves**

Adjustable shelves including 4 shelf supports. Specification: steel sheet, galvanised, slotted. Long sides folded by 4 × 90°. 30 mm thick with load-bearing capacity of 60 or 100 kg.

D ↗ For cabinet depth mm	Load capacity kg	Art. no.
<b>Adjustable shelf</b>		
<b>580</b>	60	<b>58.108.000</b>
<b>580</b>	100	<b>60.409.000</b>
Usable dimensions (W × D mm)		980 × 506



**Dividers for adjustable shelves**

For subdividing adjustable shelves. Specification: steel sheet, painted. Colour: light grey, RAL 7035.

<b>Divider for adjustable shelf</b>		
<b>580</b>	L 490 × H 150 mm	<b>58.146.000</b>

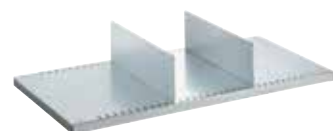

**Drawers and pull-out shelves**

Full extension with ball bearings, including guide rails. Load capacity 50 kg. Specification: steel sheet. Colour: anthracite grey, RAL 7016.

Drawer	H ↑	Usable height mm	
<b>580</b>	95	72	<b>58.113.000</b>
<b>580</b>	145	122	<b>57.471.000</b>
Usable dimensions (W × D mm)		867 × 459	



Pull-out shelf	H ↑	Usable height mm	
<b>580</b>	53	43	<b>58.115.000</b>
Usable dimensions (W × D mm)		867 × 459	

**Base**

Robust steel tubing construction 40 × 40 mm, closed side panels, incl. fastening material (screw connection between cabinet and base). Optional: base cover to be attached as a cover on the front or rear. Colour: Anthracite grey, RAL 7016.

<b>Base</b>	H ↑	
<b>580</b>	150	<b>98.216.000</b>
<b>Base cover, H 150 mm</b>		<b>97.986.000</b>

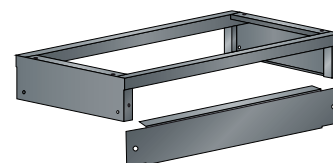

Partition material see p. 176

## Cabinet systems | Vertical pull-out cabinets

- + Utmost stability**  
with a housing load capacity of up to 1000 kg
- + High load capacities**  
vertical pull-outs with a load capacity of up to 200 kg
- + Perfectly smooth running**  
can be fully extended on smooth-running plastic runners even with heavy weights off-floor
- + Outstanding safety features**  
through standard single-drawer blocking system
- + Secure locking**  
thanks to front covers or hinged doors with KEY Lock including replaceable cylinders (other locking systems are available on request)
- + Flexible configuration options**  
with adjustable shelves, perforated panels and shelves for tool holders for NC storage in increments of 50 mm
- + User-friendly**  
with direct access to tools and small parts from both sides
- + Well protected**  
protection from dirt, liquids and physical loads thanks to closed housing with impact-resistant and abrasion-resistant surface



**Vertical pull-out cabinets from LISTA provide space-saving storage for tools, supplies and more where space is at a premium.** The pull-outs can be used from both sides and can optionally be fitted with perforated panels or shelves to hold plastic containers, tools, documents and LISTA tool holders for NC storage. The result: maximum storage space with a very small footprint. That's what we call efficient.



Art. no. **85.799.010**  
Fronts light blue, RAL 5012  
(excluding storage containers)

**Vertical pull-out cabinets**

Depending on the model, all cabinets on this page are equipped with: front covers 3 x W 307 mm, 4 x W 230 mm, pull-outs with a load capacity of 200 kg, perforated panels with square holes 10 x 10 mm, 38 mm apart



Art. no. **85.789.050**  
Doors metallic grey, NCS S 6502-B  
(excluding tools)

**H** ↑ 1950 mm    **W** → 1000 mm    **D** ↗ 695 mm



Specification

**Cabinet with front covers for NC storage**

3 or 4 pull-outs with 4 adjustable shelves each for LISTA NC tool holder (see p. 102), usable dimensions: W 118 x D 554 mm, accommodation length for NC tool holder = 554 mm

Pull-outs	📦	🔒	Art. no.
3	200	KEY Lock	<b>82.979.XXX</b>
4	200	KEY Lock	<b>82.980.XXX</b>



**Cabinet with front covers and adjustable shelves**

3 or 4 pull-outs with 4 adjustable shelves each, plain, usable dimensions: W 291/210 x D 584 x H 25 mm

3	200	KEY Lock	<b>85.792.XXX</b>
4	200	KEY Lock	<b>85.799.XXX</b>



**Cabinet with front covers and perforated panels**

3 or 4 pull-outs with perforated panels, H 1700 x D 612 mm, can be used on both sides

3	200	KEY Lock	<b>85.798.XXX</b>
4	200	KEY Lock	<b>85.791.XXX</b>

**H** ↑ 1950 mm    **W** → 1000 mm    **D** ↗ 600 mm



Specification

**Cabinet with 2 hinged doors and perforated panels**

3 or 4 pull-outs with perforated panels, H 1700 x D 560 mm, can be used on both sides, door fitted with hinges, opening angle 115°

Pull-outs	📦	🔒	Art. no.
3	200	KEY Lock	<b>85.789.XXX</b>
4	200	KEY Lock	<b>85.788.XXX</b>



**Adjustable shelves**

The adjustable shelves in two available widths provide optimum storage space for stored items.



**NC storage**

Safe and space-saving storage of tools in the vertical pull-outs in exchangeable frames.



**Perforated panels**

Pull-out perforated panels enable flexible attachment of stored items thanks to a wide range of hooks.

➤ For NC tool holders and partitioning schemes see p. 101

➤ For pegboard hooks, plastic storage containers see p. 162

200 📦 per pull-out



**LISTA heavy-duty cabinets are perfect for storing heavy materials on adjustable shelves, pull-out shelves and in drawers.** Additionally, all common access protection solutions, from retracting doors and hinged doors to vertical roller shutters, can be used. For greater transparency of stored items, doors can be supplied with viewing windows on request.



- + Utmost stability**  
with a housing load capacity of up to 1500 kg
- + High load capacities**  
160 kg per adjustable shelf, 200 kg per drawer/  
pull-out shelf
- + Outstanding safety features** – with single  
drawer blocking mechanism for heavy-duty cabinets with  
retracting doors to prevent the cabinet from tipping over
- + User-friendly**  
because of the fast access to all stored items –  
retracting doors or smooth-running roller shutters with  
user-friendly push handle
- + Secure locking**  
with retracting doors, hinged doors or roller shutter  
and intelligent locking systems like CODE/RFID Lock
- + Well protected**  
protection from dirt, liquids and physical loads thanks  
to closed housing with impact-resistant and abrasion-  
resistant surface
- + Perfectly organised**  
with viewing windows made from UV-resistant,  
shatterproof acrylic
- + Can be adapted to new storage items at any time**  
with the flexible integration and rearrangement of drawers,  
pull-out shelves and adjustable shelves in increments of 25 mm
- >> Fully compatible with LISTA drawer cabinets  
and drawer storage walls because of the  
standardised unit of measure**  
see p. 38 and/or 84





Art. no. **59.542.010**  
Light blue, RAL 5012

Art. no. **59.543.070**  
Ruby red, RAL 3003  
(excluding partition material)

**Heavy-duty cabinets with retracting doors**

The cabinets are equipped with: adjustable shelves, galvanised, 33 mm thick, pull-out shelves and drawers, painted, generally grey, NCS 4502-B. Retracting doors folded from one piece, optionally either in solid sheet steel or with viewing windows. Fitted in hinge brackets, retracting range 90°, projection of doors when opened is 85 mm. Anti-tilting is ensured by the single-drawer blocking system. Available with KEY Lock, CODE Lock or RFID Lock locking systems.

**54 × 27 E**    **H** ↑ **1950 mm**    **W** → **1146 mm**    **D** ↗ **690 mm**



Drawers    Adjustable shelves    Pull-out shelves       Hinge pins mounted       Art. no.

**Cabinets with 2 solid sheet retracting doors**

-	4	-	160	Hinge bracket	KEY Lock	<b>59.541.XXX</b>
2 × 75 / 1 × 150	2	2	160/200	Hinge bracket	KEY Lock	<b>59.543.XXX</b>

**Cabinets with 2 viewing window retracting doors**

-	4	-	160	Hinge bracket	KEY Lock	<b>59.540.XXX</b>
2 × 75 / 1 × 150	2	2	160/200	Hinge bracket	KEY Lock	<b>59.542.XXX</b>



**Retracting doors**

- disappear in the housing when opened in order to give the best possible access (doors only project by 85 mm)
- folded from a single piece
- either made of full sheet steel or equipped with viewing windows
- fitted into hinge brackets, retracting range 90°
- KEY Lock, CODE Lock or RFID Lock locking systems



- fully extendable
- load capacity up to 200 kg



**Robust housing**

- welded sheet steel construction with integrated support pillar system



**i** When ordering a cabinet from these two pages with **CODE** or **RFID Lock** locking system, please add the suffix **"C"** or **"F"** to the article number given in the table (e.g. **98.081.XXX.C**).



» For partition material see p. 248

» For LISTA Script labelling system see p. 268



# Cabinet systems | preconfigured heavy-duty cabinets



Art. no. **98.091.100**  
Signal blue, RAL 5005



Art. no. **98.086.050**  
Metallic grey, NCS S 6502-B

## Heavy-duty cabinets with hinged doors

The cabinets are equipped with: adjustable shelves, galvanised, 35 mm thick, pull-out shelves and drawers, painted, generally grey, NCS 4502-B. Hinged doors folded from one piece, optionally either in solid sheet steel or with viewing windows. KEY, CODE or RFID Locks available.



**54 × 27 E**      **H** ↑ 1950 mm      **W** → 1100 mm      **D** ↗ 641 mm



Drawers	Adjustable shelves	Pull-out shelves	160	Hinge pins mounted		Art. no.
<b>Cabinets with 2 solid sheet hinged doors</b>						
-	4	-	160	Pin hinge	KEY Lock	<b>98.081.XXX</b>
1 × 100 / 1 × 150	3	-	160/200	Pin hinge	KEY Lock	<b>98.085.XXX</b>
2 × 100 / 2 × 150	2	1	160/200	Pin hinge	KEY Lock	<b>98.093.XXX</b>

<b>Cabinets with 2 viewing window hinged doors</b>						
-	4	-	160	Pin hinge	KEY Lock	<b>98.082.XXX</b>
1 × 100 / 1 × 150	3	-	160/200	Pin hinge	KEY Lock	<b>98.086.XXX</b>
2 × 100 / 2 × 150	2	1	160/200	Pin hinge	KEY Lock	<b>98.094.XXX</b>

## Hinged doors

- folded from a single piece
- either made of solid sheet steel or equipped with viewing windows
- with pin hinge, opening angle approx. 115°
- Lock with KEY, CODE or RFID Lock

**i** When ordering a cabinet from these two pages with **CODE** or **RFID Lock**, please add the suffix **"C"** or **"F"**, respectively, to the article number stated in the table (e.g. **98.081.XXX.C**).



## Heavy-duty cabinets with roller shutter

The cabinets are equipped with: adjustable shelves, galvanised, 35 mm thick, pull-out shelves and drawers, painted, generally grey, NCS 4502-B. The smooth-running PVC roller shutter stops at any height without locking. Colour: aluminium colours, the colour of the strike plate with KEY Lock locking system is variable.

**54 × 27 E**      **H** ↑ 1950 mm      **W** → 1100 mm      **D** ↗ 641 mm



Drawers	Adjustable shelves	Pull-out shelves	160	Hinge pins mounted		Art. no.
<b>Cabinets with roller shutter</b>						
-	4	-	160	-	KEY Lock	<b>98.083.XXX</b>
2 × 100	4	-	160/200	-	KEY Lock	<b>98.091.XXX</b>



## Roller shutter

- especially suitable when space is limited
- stops at any height without the need for catches
- aluminium colours, colour of strike plate variable
- KEY Lock locking system

**>>** For partition material sets and labelling system see p. 248.





Art. no. **98.096.010**  
Pale blue, RAL 5012

Art. no.  
**59.544.010**  
**59.532.010**  
Pale blue, RAL 5012

**i** Tilt protection is ensured by the multiple pull-out lock; only applies to retracting doors.

**Drawers**

Drawers with different front heights can be incorporated into the same housing in any order. The insides of the drawer walls are all fitted with a slotted grid in units (E) of 17 mm so that each drawer can be partitioned as required. Colour: grey, NCS 4502-B.

**Pull-out shelves**

For storing heavy individual items and equipment. Perfectly fitting, variable height assembly of 25 x 25 mm in the cabinet housing. The inserted slats enable stored items to be stored and removed flush with the handle. Specification: steel sheet. Colour: grey, NCS 4502-B. Slats are made of shaped sheet steel profile, sendzimir galvanised.

**Adjustable shelves, slotted or plain**

Adjustable shelves including 4 shelf supports. Adjustable shelf, slotted, **fitting against the rear**. Specification: steel sheet, galvanised. Long sides folded 4 x 90°. Slotted partition; 50 mm. Load capacity: 160 kg.

**Dividers for adjustable shelves**

Slotted for separating 2 adjustable shelves attached one above the other. The height of the dividers depends on the distance between the adjustable shelves. Specification: steel sheet. Colour: light grey, RAL 7035.

**Base**

Robust steel tubing construction 40 x 40 mm, closed side panels, incl. fastening material (screw connection between cabinet and base). Optional: base cover to be attached as a cover on the front or rear. Colour: Anthracite grey, RAL 7016.

<b>54 x 27 E</b>	<b>W → × D ↗</b>	<b>1100 x 641</b>	<b>1146 x 690</b>
<b>H ↑ Cabinet height mm</b>		<b>1950</b>	<b>1950</b>
	Clear height (mm)	1790/ 1640	1830
	for design	<b>Hinged doors roller shutter</b>	<b>Retracting doors</b>
		Art. no.	Art. no.
<b>Housing</b>		<b>98.096.XXX</b>	<b>59.544.XXX</b>
<b>Hinged doors excl. clasp lock</b>			
Solid sheet		<b>62.031.XXX</b>	-
Viewing window		<b>62.032.XXX</b>	-
<b>Retracting doors excl. clasp lock</b>			
Solid sheet		-	<b>59.532.XXX</b>
Viewing window		-	<b>59.535.XXX</b>
<b>+ clasp lock</b>			
Key Lock, separately lockable		<b>49.060.000</b>	<b>49.060.000</b>
CODE Lock		<b>49.085.000</b>	<b>49.085.000</b>
RFID Lock		<b>49.086.000</b>	<b>49.086.000</b>
<b>Roller shutter excl. cylinder lock</b>		<b>98.097.XXX</b>	-
+ push handle cylinder lock		<b>62.062.000</b>	-

<b>H ↑</b>	Usable height mm	Cladding height mm		
<b>Drawers</b>				
<b>75</b>	57.5	49	<b>85.700.080</b>	<b>85.700.080</b>
<b>100</b>	82.5	76	<b>85.701.080</b>	<b>85.701.080</b>
<b>150</b>	132.5	126	<b>85.702.080</b>	<b>85.702.080</b>
<b>200</b>	182.5	176	<b>85.703.080</b>	<b>85.703.080</b>
Usable dimension W x D mm			918 x 459	918 x 459
Load capacity kg			200	200

<b>Pull-out shelf</b>	<b>85.704.080</b>	<b>85.704.080</b>
Usable dimension W x D mm	918 x 459	918 x 459
Height mm	75	75
Load capacity kg	200	200

<b>Adjustable shelf</b>	<b>98.098.000</b>	<b>59.545.000</b>
Usable dimension W x D mm	967 x 549	966 x 500
Height mm	35	33
Load capacity kg	160	160
Model	Plain	Slotted

	Usable height mm	Distance between shelves TE-TE* mm		
<b>Dividers</b>	179	225	-	<b>59.415.000</b>
	329	375	-	<b>59.416.000</b>

\* Distance between shelves from top edge to top edge

<b>Base, H 150 mm</b>	<b>97.588.000</b>	<b>59.412.000</b>
<b>Base cover</b>	<b>98.246.000</b>	<b>62.888.000</b>

**Clothing lockers from LISTA offer impressive functionality and a wide variety of equipment options.**

This makes them suitable for use in a wide range of locations from workshop to sports hall and they also offer secure, flexible and ideal storage in accordance with DIN 4547-2011.



**+ Utmost stability**  
thanks to hinged doors with the pin on the right and with reinforcement pocket for greater protection against burglary (DIN 4547)

**+ Sophisticated ventilation**  
with air vents at the top and bottom of the housing

**+ Optimum hygiene**  
thanks to plain compartment shelves without raised edge to make it easier to clean the compartments thoroughly

**+ Practical interior fittings**  
with hat rack, towel holder and clothes rail with three sliding coat hooks for each compartment

**+ Individual equipment options**  
such as housing with an inclined top, double compartments, benches or ventilation ducts for on-site forced ventilation

**+ Secure locking**  
with KEY Lock locking system, rotary knob safety lock or closing device for padlock (CODE/RFID Lock and other locking systems on request)

**+ Protection from dirt and corrosion**  
with bases or legs that are galvanised in addition to being powder-coated. Protect against corrosion, cover with a base also protects against dirt



Art. no. **94.424.080**  
Pigeon grey, NCS S 4502-B

## Clothing lockers

1-leaf for 1 lockable compartment

### Equipment per compartment

single-leaf solid sheet door, flush-fitting, surface plain or with perforated field for additional ventilation (1 compartment lockable)

1 hat rack

1 clothes rail, with 3 sliding coat hooks

1 towel holder

**Compartments width:** 300 or 400 mm  
**Clear height:** 1280 mm / 300 mm (hat rack)



without substructure (for bases)



with feet



with base

		300 mm			400 mm	
H → Cabinet width mm		600	900	1200	800	1200
W ↗ 500 mm	Number of compartments	2	3	4	2	3
D ↗	Door specification	Art. no.	Art. no.	Art. no.	Art. no.	Art. no.
<b>1700 mm</b>	KEY Lock plain	<b>94.414.XXX</b>	<b>94.405.XXX</b>	<b>94.417.XXX</b>	<b>94.420.XXX</b>	<b>94.411.XXX</b>
without substructure	KEY Lock perforated	<b>94.531.XXX</b>	<b>94.534.XXX</b>	<b>94.537.XXX</b>	<b>94.543.XXX</b>	<b>94.546.XXX</b>
<b>1800 mm</b>	KEY Lock plain	<b>94.426.XXX</b>	<b>94.429.XXX</b>	<b>94.432.XXX</b>	<b>94.438.XXX</b>	<b>94.441.XXX</b>
with base, 100 mm	KEY Lock perforated	<b>94.552.XXX</b>	<b>94.555.XXX</b>	<b>94.558.XXX</b>	<b>94.564.XXX</b>	<b>94.567.XXX</b>
<b>1850 mm</b>	KEY Lock plain	<b>94.447.XXX</b>	<b>94.450.XXX</b>	<b>94.453.XXX</b>	<b>94.459.XXX</b>	<b>94.462.XXX</b>
with feet, 150 mm	KEY Lock perforated	<b>94.573.XXX</b>	<b>94.576.XXX</b>	<b>94.579.XXX</b>	<b>94.585.XXX</b>	<b>94.588.XXX</b>



Art. no. **94.417.010**  
Light blue, RAL 5012



**i** Battery charging cabinets with clothes lockers can be found on page 210.



### Clothing lockers

1-leaf for 2 lockable compartments

#### Equipment per compartment

single-leaf solid sheet door, flush-fitting, surface plain or with perforated field for additional ventilation (2 compartments lockable)

- 1 hat rack
- 1 clothes rail, with 3 sliding coat hooks
- 1 towel holder

**Compartments width:** 300 mm  
**Clear height:** 1280 mm / 300 mm (hat rack)



#### Sophisticated ventilation system

- the air vents located on the top and bottom of the housing ensure permanent circulation of air in the locker
- door models with individual perforation pattern on request

		compartment width		300 mm	
<b>H</b> →	Cabinet width mm	600	1200		
<b>W</b> ↗	500 mm	Number of compartments	2	4	
<b>D</b> ↑	🔒	Door specification	Art. no. 🌈	Art. no. 🌈	
<b>1700 mm</b>	KEY Lock	plain	94.302.XXX	94.305.XXX	
without substructure	KEY Lock	perforated	94.320.XXX	94.323.XXX	
<b>1800 mm</b>	KEY Lock	plain	94.308.XXX	94.311.XXX	
with base, 100 mm	KEY Lock	perforated	94.326.XXX	94.329.XXX	
<b>1850 mm</b>	KEY Lock	plain	94.314.XXX	94.317.XXX	
with feet, 150 mm	KEY Lock	perforated	94.332.XXX	94.335.XXX	



#### Air duct

Elimination of odours thanks to high air exchange rate and improved drying through on-site forced ventilation.

Air duct on request.

### Clothing lockers

2-leaf for 2 lockable compartments

#### Equipment per compartment

2 solid leaf door, flush fitting, surface plain or with perforated field for additional ventilation (2 compartments lockable)

- 1 hat rack
- 1 clothes rail, with 3 sliding coat hooks
- 1 towel holder

**Compartments width:** 300 or 400 mm  
**Clear height:** 1280 mm / 300 mm (hat rack)



#### Inclined top

Clothes lockers with an inclined top prevent undesired use of the cabinet top as shelf space.

Inclined top on request.

		compartment width		300 mm		400 mm	
<b>H</b> →	Cabinet width mm	600	1200	800			
<b>W</b> ↗	500 mm	Number of compartments	2	4	2		
<b>D</b> ↑	🔒	Door specification	Art. no. 🌈	Art. no. 🌈	Art. no. 🌈		
<b>1700 mm</b>	KEY Lock	plain	94.342.XXX	94.348.XXX	94.345.XXX		
without substructure	KEY Lock	perforated	94.369.XXX	94.375.XXX	94.372.XXX		
<b>1800 mm</b>	KEY Lock	plain	94.351.XXX	94.357.XXX	94.354.XXX		
with base, 100 mm	KEY Lock	perforated	94.378.XXX	94.384.XXX	94.381.XXX		
<b>1850 mm</b>	KEY Lock	plain	94.360.XXX	94.366.XXX	94.363.XXX		
with feet, 150 mm	KEY Lock	perforated	94.387.XXX	94.393.XXX	94.390.XXX		



#### Wide range of accessories

On request, you may also order benches, shoe racks, name and number plates, towel holders and more.



#### Versatile locking systems

cylinder locks, numeric combination locks, coin deposit locks, locking systems for padlocks and master key systems are available. Other locks available on request.

**i** When ordering a clothes locker from this double page with **closing device for padlock**, please specify the suffix "V", or, for **rotary knob safety lock**, use the suffix "D" in addition to the article number from the table (e.g. 94.429.XXX.V)



#### Base makes cleaning simpler

The closed base border on the floor makes it easy to clean changing room areas.

# Cabinet systems | Dual-level clothing lockers



Art. No. **94.424.080**  
Pigeon grey, NCS S 4502-B

## Dual-level clothing lockers

**equipment for each compartment**  
single-leaf solid sheet door, flush-fitting, surface plain or with perforated field for additional ventilation (1 compartment lockable)  
1 hat rack  
1 clothes rail, with 3 sliding coat hooks  
1 towel holder

**Compartments width:** 300 or 400 mm  
**Clear height:** 1280 mm (for top and bottom compartment)



without substructure (for bases)



with feet



with base

		300 mm			400 mm	
<b>H</b> → Cabinet width mm	compartment width	600	900	1200	800	1200
<b>W</b> ↗ 500 mm	Number of compartments	2 × 2	3 × 2	4 × 2	2 × 2	3 × 2
<b>D</b> ↑	Door specification	Art. no.	Art. no.	Art. no.	Art. no.	Art. no.
<b>1700 mm</b>	KEY Lock plain	<b>94.468.XXX</b>	<b>94.471.XXX</b>	<b>94.474.XXX</b>	<b>94.480.XXX</b>	<b>94.483.XXX</b>
without substructure	KEY Lock perforated	<b>94.594.XXX</b>	<b>94.597.XXX</b>	<b>94.600.XXX</b>	<b>94.606.XXX</b>	<b>94.609.XXX</b>
<b>1800 mm</b>	KEY Lock plain	<b>94.489.XXX</b>	<b>94.492.XXX</b>	<b>94.495.XXX</b>	<b>94.501.XXX</b>	<b>94.504.XXX</b>
with base, 100 mm	KEY Lock perforated	<b>94.615.XXX</b>	<b>94.618.XXX</b>	<b>94.621.XXX</b>	<b>94.627.XXX</b>	<b>94.630.XXX</b>
<b>1850 mm</b>	KEY Lock plain	<b>94.510.XXX</b>	<b>94.513.XXX</b>	<b>94.516.XXX</b>	<b>94.522.XXX</b>	<b>94.525.XXX</b>
with feet, 150 mm	KEY Lock perforated	<b>94.636.XXX</b>	<b>94.639.XXX</b>	<b>94.642.XXX</b>	<b>94.648.XXX</b>	<b>94.651.XXX</b>





<b>H</b> → Cabinet width mm	<b>600</b>	<b>800</b>	<b>900</b>	<b>1200</b>
-----------------------------	------------	------------	------------	-------------



### Single- or double-sided base, height 150 mm

Welded steel construction with angle profiles and adjustable plastic legs for levelling. Colour: Anthracite grey, RAL 7016.  
**Note:** double-sided (for 2 cabinets, back to back)

#### Base, H 150 mm

<b>W</b> mm	Model	Art. no.	Art. no.	Art. no.	Art. no.
500	single-sided	94.252.000	94.253.000	94.254.000	94.255.000
1000	double-sided	94.264.000	94.265.000	94.266.000	94.267.000

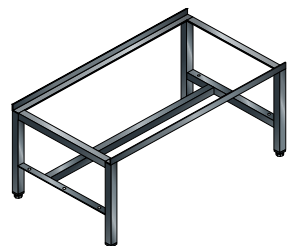

### Single-sided or double-sided base, height 400 mm

Welded steel construction with angle profiles and adjustable plastic legs for levelling. Colour: Anthracite grey, RAL 7016.  
**Note:** double-sided (for 2 cabinets, back to back)

#### Base, H 400 mm

<b>W</b> mm	Model	Art. no.	Art. no.	Art. no.	Art. no.
500	single-sided	97.110.000	97.473.000	97.143.000	97.111.000
1000	double-sided	97.108.000	98.444.000	97.870.000	97.109.000

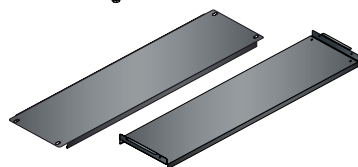

#### Shoe rack

<b>W</b> mm	Model	Art. no.	Art. no.	Art. no.	Art. no.
230	secure	97.156.000	97.472.000	97.144.000	97.157.000
230	folds upward	98.230.000	98.683.000	98.617.000	98.231.000



### Single-sided or double-sided base, height 400 mm

Welded steel construction with angle profiles and adjustable plastic legs for levelling. Colour: Anthracite grey, RAL 7016.  
**Note:** double-sided (for 2 cabinets, back to back). Bench depth: 300 mm.

#### Base, H 400 mm

<b>W</b> mm	Model	Art. no.	Art. no.	Art. no.	Art. no.
500	single-sided	94.946.000	94.947.000	94.948.000	94.949.000
1000	double-sided	94.950.000	94.951.000	94.952.000	94.953.000



### Fixed or fold-up shoe rack

Can be attached to the bases using attachment brackets without screws. Number required: 1 per clothes locker. Colour: Attachment brackets anthracite grey, RAL 7016; shoe racks galvanised anthracite grey, RAL 7016. Bench depth: 300 mm.

#### Shoe rack

<b>W</b> mm	Model	Art. no.	Art. no.	Art. no.	Art. no.
230	secure	94.954.000	94.955.000	94.956.000	94.957.000
	Distance between stands mm	310	510	610	910
	Shelf length mm	336	536	636	936
230	folds upward	94.966.000	94.967.000	94.968.000	94.696.000
	Distance between stands mm	310	510	610	910
	Shelf length mm	285	485	585	885



### Bench base for in-line installation on request

Upon presentation of a layout plan, the bases are available at **little cost** for single- and/or double-sided construction in a row. In addition, less cleaning is required thanks the small number of leg supports.



### Double-sided base, height 400 mm with shoe racks

**LISTA compartment cabinets are ideal for storing personal items of all kinds.** Whether in industry, trades, office and administration, or leisure and sport: a variety of locking systems makes the cabinets easily adaptable to the respective security requirements of any location.

**+ Utmost stability**  
thanks to hinged doors with the pin on the right, rolled on all sides, with curved surface

**+ Sophisticated ventilation**  
with air vents at the top and bottom of the door

**+ Secure locking**  
with KEY Lock locking system or locking mechanism for padlock (CODE/RFID Lock and other locking systems on request)

**+ Clearly labelled**  
thanks to embossed label frame

**+ Protection from dirt**  
thanks to substructure with base to prevent dirt from accumulating under the locker



Art. no. **11.527.050**  
Metallic grey, NCS S 6502-B



Art. no. **11.529.010**  
Light blue, RAL 5012



### Compartment doors

Different compartment doors, e.g. with viewing windows or mail slot, on request



### Inclined top part

An inclined top part prevents the cover from being used inadvertently as shelf space and reduces required cleaning.

### Ventilation slots and label frames

The high-quality solid sheet doors provide very high stability and are also equipped with a label frame. Air vents at the top and bottom provide ideal ventilation.

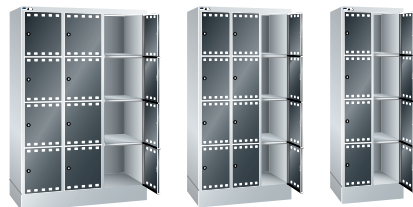

### Versatile locking systems

cylinder locks, numeric combination locks, coin deposit locks, locking systems for padlocks and master key systems are available. Other locking devices such as CODE/RFID Lock on request.

### i Ordering information



When ordering a compartment cabinet with **closing device for a padlock**, please specify the suffix **"V"** or, for a **rotary knob safety lock**, the suffix **"D"** in addition to the article number from the table (e.g. **11.525.XXX.V**).

		Compartment width			400 mm		
		Clear compartment width			340 mm		
<b>D</b> ↗ 500 mm	<b>W</b> → Cabinet width mm	610	905	1200	415	810	1205
<b>H</b> ↑	<b>H</b> ↑	Number of compartments ↔			1	2	3
with base H 150 mm	Compartment Clear compart- ment height	Number of compart- ments	Lock		Art. no.	Art. no.	Art. no.
<b>1095 mm</b>	300 mm 280 mm	3	KEY Lock	-	<b>11.513.XXX</b>	-	-
<b>1395 mm</b>	300 mm 280 mm	4	KEY Lock	<b>11.507.XXX</b>	<b>11.515.XXX</b>	-	-
<b>1695 mm</b>	300 mm 280 mm	5	KEY Lock	<b>11.509.XXX</b>	<b>11.517.XXX</b>	<b>11.521.XXX</b>	-
<b>1795 mm</b>	400 mm 380 mm	4	KEY Lock	<b>11.501.XXX</b>	<b>11.503.XXX</b>	<b>11.505.XXX</b>	<b>11.525.XXX</b> <b>11.527.XXX</b> <b>11.529.XXX</b>
<b>1995 mm</b>	300 mm 280 mm	6	KEY Lock	<b>11.511.XXX</b>	<b>11.519.XXX</b>	<b>11.523.XXX</b>	-
<b>inclined top part, H 50/200 mm</b>				<b>97.315.000</b>	<b>97.316.000</b>	<b>97.317.000</b>	<b>97.318.000</b> <b>97.319.000</b> <b>97.320.000</b>
for mounting superstructures at the factory				<b>97.558.000</b>	<b>97.558.000</b>	<b>97.558.000</b>	<b>97.558.000</b> <b>97.558.000</b> <b>97.558.000</b>

**COLOURS:** With preconfigured cabinets housing in light grey, RAL 7035.



**LISTA battery charging cabinets with hinged doors are perfect for the centralised supply of batteries and electrical devices.** All cabinets can be configured individually and adapted to your specific storage needs through the flexible use of partition materials, cabinet accessories and power supply by means of power strips.

**+ Flexible range of applications**  
Charging options for battery-operated electrical machines, BDE devices, notebooks, tablets and smartphones

**+ Perfect cable management**  
Cable openings for protected and orderly cable routing

**+ Outstanding safety features**  
CE compliant

**+ Secure locking**  
Devices are locked away at all times, and are protected against unauthorised use and with intelligent locking systems such as CODE/RFID Lock.

**>> Benefits of LISTA cabinet systems**  
See p. 168

### Battery charging cabinets with hinged doors

Depending on the model, the cabinets are equipped with **adjustable shelves**, galvanised, 30 mm thick, load capacity 60 kg. Painted **drawers**, anthracite gray (RAL 7016), load capacity 50 kg. **Power strips** with on/off switches and 4 or 5 sockets, 230 V.



Art. No. **62.955.020**  
Solid sheet hinged door,  
light grey (RAL 7035)

Art. No. **62.976.020**  
Viewing window hinged door,  
light grey (RAL 7035)

Art. No. **62.959.020**  
Solid sheet hinged door,  
light grey (RAL 7035)



#### Hinged doors with viewing windows

- For greater transparency of stored items
- Encourages order

**i** When ordering a cabinet from these two pages with **CODE** or **RFID Lock**, please add the suffix **"C"** or **"F"**, respectively, to the article number stated in the table (e.g. **62.955.XXX.C**).



<b>W</b> → 1000 mm	<b>D</b> ↗ 580 mm	<b>H</b> ↑ 1950 mm	Solid sheet doors	Viewing windows
--------------------	-------------------	--------------------	-------------------	-----------------

Number of power strips	Mounting position, power strips	Adjustable shelves	Drawers	kg	Door storage		Art. No.	Art. No.
<b>Model D / Schuko</b>								
1 × 5-socket (230V)	On side panel	4	–	60	Hinge	KEY Lock	<b>62.954.XXX</b>	<b>62.972.XXX</b>
2 × 5-socket (230V)	On side panel	4	–	60	Hinge	KEY Lock	<b>62.955.XXX</b>	<b>62.973.XXX</b>
1 × 5-socket (230V)	On rear panel/power conduit	4	–	60	Hinge	KEY Lock	<b>62.956.XXX</b>	<b>62.974.XXX</b>
2 × 5-socket (230V)	On rear panel/power conduit	4	–	60	Hinge	KEY Lock	<b>62.957.XXX</b>	<b>62.975.XXX</b>
2 × 5-socket (230V)	On rear panel/power conduit	3	2 × 95	60/50	Hinge	KEY Lock	<b>62.959.XXX</b>	<b>62.977.XXX</b>
2 × 5-socket (230V), RCD/MCB**	On rear panel/power conduit	4	–	60	Hinge	KEY Lock	<b>62.958.XXX</b>	<b>62.976.XXX</b>
<b>Model CH</b>								
1 × 4-socket (230V)*	On side panel	4	–	60	Hinge	KEY Lock	<b>62.966.XXX</b>	<b>62.984.XXX</b>
2 × 4-socket (230V)*	On side panel	4	–	60	Hinge	KEY Lock	<b>62.967.XXX</b>	<b>62.985.XXX</b>
1 × 4-socket (230V)*	On rear panel/power conduit	4	–	60	Hinge	KEY Lock	<b>62.968.XXX</b>	<b>62.986.XXX</b>
2 × 4-socket (230V)*	On rear panel/power conduit	4	–	60	Hinge	KEY Lock	<b>62.969.XXX</b>	<b>62.987.XXX</b>
2 × 4-socket (230V)*	On rear panel/power conduit	3	2 × 95	60/50	Hinge	KEY Lock	<b>62.971.XXX</b>	<b>62.989.XXX</b>
2 × 4-socket (230V)*, RCD/MCB**	On rear panel/power conduit	4	–	60	Hinge	KEY Lock	<b>62.970.XXX</b>	<b>62.988.XXX</b>
<b>Model F</b>								
1 × 5-socket (230V)	On side panel	4	–	60	Hinge	KEY Lock	<b>62.960.XXX</b>	<b>62.978.XXX</b>
2 × 5-socket (230V)	On side panel	4	–	60	Hinge	KEY Lock	<b>62.961.XXX</b>	<b>62.979.XXX</b>
1 × 5-socket (230V)	On rear panel/power conduit	4	–	60	Hinge	KEY Lock	<b>62.962.XXX</b>	<b>62.980.XXX</b>
2 × 5-socket (230V)	On rear panel/power conduit	4	–	60	Hinge	KEY Lock	<b>62.963.XXX</b>	<b>62.981.XXX</b>
2 × 5-socket (230V)	On rear panel/power conduit	3	2 × 95	60/50	Hinge	KEY Lock	<b>62.965.XXX</b>	<b>62.983.XXX</b>
2 × 5-socket (230V), RCD/MCB**	On rear panel/power conduit	4	–	60	Hinge	KEY Lock	<b>62.964.XXX</b>	<b>62.982.XXX</b>
<b>Model GB</b>								
1 × 5-socket (230V)	On side panel	4	–	60	Hinge	KEY Lock	<b>57.145.XXX</b>	<b>57.151.XXX</b>
2 × 5-socket (230V)	On side panel	4	–	60	Hinge	KEY Lock	<b>57.146.XXX</b>	<b>57.152.XXX</b>
1 × 5-socket (230V)	On rear panel/power conduit	4	–	60	Hinge	KEY Lock	<b>57.147.XXX</b>	<b>57.153.XXX</b>
2 × 5-socket (230V)	On rear panel/power conduit	4	–	60	Hinge	KEY Lock	<b>57.148.XXX</b>	<b>57.154.XXX</b>
2 × 5-socket (230V)	On rear panel/power conduit	3	2 × 95	60/50	Hinge	KEY Lock	<b>57.150.XXX</b>	<b>57.156.XXX</b>
2 × 5-socket (230V), RCD/MCB**	On rear panel/power conduit	4	–	60	Hinge	KEY Lock	<b>57.149.XXX</b>	<b>57.155.XXX</b>

\* With 1 × thermal fuse

\*\* RCD = residual current protective device (16A/30 mA), MCB = miniature circuit breaker (CH = 10A, D/F = 16A)

50 drawers/pull-out shelves  
 60 adjustable shelves

# Cabinet systems | Battery charging cabinets with hinged doors

**W** → Cabinet width mm

**750**

**1000**

**1250**



## Cabinet housing

incl. rubber grommets for protected cable feed through perforated rear panel in housing (punch-out) for optional fan installation.

<b>D</b> →	<b>H</b> ↑	Door storage	Art. No. 🌈	Art. No. 🌈	Art. No. 🌈
500 mm	1000 mm	Hinge	-	62.779.XXX	-
500 mm	1950 mm	Hinge	62.792.XXX	62.780.XXX	62.794.XXX
580 mm	1000 mm	Hinge	-	62.777.XXX	-
580 mm	1950 mm	Hinge	62.793.XXX	62.778.XXX	62.795.XXX



## Hinged doors

2 doors excl. clasp lock (must be ordered separately)

	<b>H</b> ↑	Door storage	Art. No. 🌈	Art. No. 🌈	Art. No. 🌈
<b>Solid sheet</b>	1000 mm	Hinge	-	62.009.XXX	-
<b>Solid sheet</b>	1950 mm	Hinge	62.006.XXX	62.011.XXX	62.016.XXX
<b>Viewing window</b>	1000 mm	Hinge	-	62.137.XXX	-
<b>Viewing window</b>	1950 mm	Hinge	-	62.012.XXX	62.017.XXX

## Adjustable shelf

Incl. 4 shelf supports. Specification: sheet steel, galvanised, slotted. Long sides folded by 4 × 90°. 30 mm thick with load-bearing capacity of 60 or 100 kg.



<b>D</b> →	For cabinet depth	kg	Art. No.	Art. No.	Art. No.
500 mm		60	58.104.000	58.107.000	58.110.000
500 mm		100	-	60.407.000	60.408.000
580 mm		60	58.105.000	58.108.000	58.111.000
580 mm		100	-	60.409.000	60.434.000
Usable dimensions (W × D mm)			730 × 425/506	980 × 425/506	1230 × 425/506

## Divider for adjustable shelf

For partitioning adjustable shelves. Specification: sheet steel, painted. Colour: light grey, RAL 7035.



<b>D</b> →	For cabinet depth	Art. No.	Art. No.	Art. No.
500 mm	W 411 × H 150 mm	58.145.000	58.145.000	58.145.000
580 mm	W 490 × H 150 mm	58.146.000	58.146.000	58.146.000

## Drawers and pull-out shelves

Full extension with ball bearings, including guide rails. Load capacity 50 kg. Specification: sheet steel. Colour: anthracite gray, RAL 7016. Only compatible with cabinets with hinge bearing assembly and a depth of 580 mm.



		Art. No.	Art. No.	Art. No.
<b>Drawer, FH 95 mm</b>		62.308.000	58.113.000	57.481.000
<b>580 mm</b>	Usable dimensions (W × D × H mm)	617 × 459 × 72	867 × 459 × 72	1117 × 459 × 72
<b>Drawer, FH 145 mm</b>		-	57.471.000	57.482.000
<b>580 mm</b>	Usable dimensions (W × D × H mm)	-	867 × 459 × 122	1117 × 459 × 122
<b>Pull-out shelf, FH 53 mm</b>		-	58.115.000	-
<b>580 mm</b>	Usable dimensions (W × D × H mm)	-	867 × 459 × 43	-

## Base

Robust steel tubing construction 40 × 40 mm, closed side panels. Includes fastening material (screw connection between cabinet and base). Optional: base cover to be attached as a cover on the front or rear. Colour: Anthracite grey, RAL 7016.

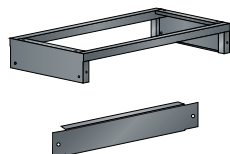

	Art. No.	Art. No.	Art. No.
<b>Base*, FH 150 mm</b>			
<b>500 mm</b>	97.844.000	98.518.000	98.253.000
<b>580 mm</b>	98.657.000	98.216.000	97.835.000
<b>Base cover, H 150 mm</b>	57.238.000	97.986.000	62.806.000



## Punch out

perforated rear housing panel for optional installation of a fan



## Hinged bearing assembly

- For the installation of drawers and pull-out shelves, doors must be fitted with hinged bearing assembly
- Doors are flush with the cabinet housing
- Opening angle approx. 115°



## KEY Lock

Art. No. 49.060.000  
Separately lockable



## CODE Lock

Art. No. 49.085.000



## RFID Lock

Art. No. 49.086.000

### Power strips

With on/off switch and sockets, 230 V, without power and connection cables

For cabinet depth	Type	Description	Art. No.
500 mm	D / PE	4-socket (230V)	<b>82.474.000</b>
500 mm	CH	3-socket (230V)*	<b>82.475.000</b>
500 mm	F	4-socket (230V)	<b>82.476.000</b>
500 mm	GB	4-socket (230V)	<b>62.902.000</b>
580 mm	D / PE	5-socket (230V)	<b>62.763.000</b>
580 mm	CH	4-socket (230V)*	<b>62.782.000</b>
580 mm	F	5-socket (230V)	<b>62.739.000</b>
580 mm	GB	5-socket (230V)	<b>62.903.000</b>

\* Incl. thermal fuse 10 A



Side panel installation

### Fastening kit for power strips

#### Side panel installation

Includes fastening material for screw connection of the power strips onto the cabinet side panel

For cabinet depth	Art. No.
500 mm	<b>62.771.000</b>
580 mm	<b>62.772.000</b>

#### Rear panel installation

Power conduit for holding the power strips (4-socket for CH and 5-socket for D, F and GB). Fastening material included. Specification: sheet steel. Colour: anthracite gray, RAL 7016.

For cabinet width	Art. No.
1000 mm	<b>62.992.000</b>
1250 mm	<b>62.996.000</b>



Rear panel installation

### Cable fastening

Cable tie and mounting base kit for 2 m cable length

Quantity	Art. No.
5 pieces	<b>390.024.000</b>



### System socket supply cable

Simple and quick electrical installation through plug and socket connector system, 3-pin.

Type	Length (m)	Art. No.
D / PE	3.0	<b>89.545.000</b>
CH	3.0	<b>89.544.000</b>
F	3.0	<b>89.545.000</b>
GB	3.0	<b>89.546.000</b>

### Fan

Incl. adapter with integrated European plug  
For GB, an adapter is required, art. no. **61.160.000**.



Type	Art. No.
12V DC 106	<b>57.467.000</b>



### Connecting cable

3-pin connector system with plug and socket

Length (m)	Art. No.
1.0	<b>89.548.000</b>
1.5	<b>390.036.000</b>
2.0	<b>89.549.000</b>
3.0	<b>89.550.000</b>



### RCD/MCB

RCD = residual current protective device (16 A)  
MCB = miniature circuit breaker (CH = 10 A, D/F = 16 A)

Quantity	Art. No.
1 piece	<b>57.101.000</b>

**i** Intermediate coupling required to connect RCD to power strip, art. no. **89.552.000**.

### LED cabinet lighting

12 V LED lighting for cabinet height 1950 mm. Installed at the front right of the cabinet. Consisting of 1 LED light each, length: 800 mm (9W) and 500 mm (5W), integrated motion detector requires 1 free slot in one power strip.

Art. No. **57.463.000**



### + Flexible range of applications

Charging options for battery-operated electrical machines, BDE devices, notebooks, tablets, smartphones or e-bikes

### + Sophisticated ventilation

Optimal air circulation thanks to ventilation holes at the front and back

### + Great design diversity

With sockets, network sockets RJ45 and USB interfaces

### + Outstanding safety features

CE compliant

### + Secure locking

Devices are locked away at all times, and are protected against unauthorised use and with intelligent locking systems such as CODE/RFID Lock

### >> Benefits of LISTA cabinet systems

See p. 168

**LISTA compartment cabinets with power connection are perfect for personal storage of battery-operated devices of all kinds.** Suitable for use in industry, trade, offices, schools, universities or public buildings. Batteries can be charged during storage thanks to the built-in double sockets, and are therefore always ready to use.





Art. no. **98.409.020**  
Light grey, RAL 7035



Art. no. **98.416.070**  
Ruby red, RAL 3003

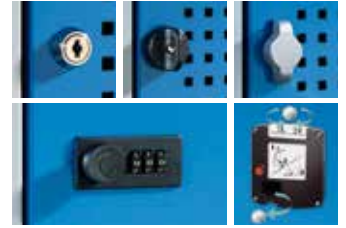

**Versatile locking systems**

• Cylinder locks, numeric combination locks, coin deposit locks, locking systems for padlocks and master key systems are available

**i** When ordering a cabinet from this page with **RFID Lock**, please add the suffix "F", respectively, to the article number stated in the table (e.g. **98.409.XXX.F**).

**H** **1795 mm, with base 150 mm high**

**W** **D** No. of compartments Shelf dimension (W×Hmm) Type Module per compartment Art. no.

**Cabinets with 8 compartments and KEY Lock**

<b>810 mm</b>	585 mm	2 × 4	400 × 400	D / PE	2 × 230V	<b>98.409.XXX</b>
<b>810 mm</b>	585 mm	2 × 4	400 × 400	D / PE	1 × 230V, 2 × USB	<b>98.415.XXX</b>
<b>810 mm</b>	585 mm	2 × 4	400 × 400	D / PE	1 × 230V, 1 × RJ45	<b>98.419.XXX</b>
<b>810 mm</b>	585 mm	2 × 4	400 × 400	CH	2 × 230V	<b>98.411.XXX</b>
<b>810 mm</b>	585 mm	2 × 4	400 × 400	CH	1 × 230V, 2 × USB	<b>98.629.XXX</b>
<b>810 mm</b>	585 mm	2 × 4	400 × 400	CH	1 × 230V, 1 × RJ45	<b>98.631.XXX</b>
<b>810 mm</b>	585 mm	2 × 4	400 × 400	F	2 × 230V	<b>98.413.XXX</b>
<b>810 mm</b>	585 mm	2 × 4	400 × 400	F	1 × 230V, 2 × USB	<b>98.417.XXX</b>
<b>810 mm</b>	585 mm	2 × 4	400 × 400	F	1 × 230V, 1 × RJ45	<b>98.421.XXX</b>
<b>810 mm</b>	585 mm	2 × 4	400 × 400	GB	2 × 230V	<b>98.455.XXX</b>
<b>810 mm</b>	585 mm	2 × 4	400 × 400	GB	1 × 230V, 2 × USB	<b>98.457.XXX</b>
<b>810 mm</b>	585 mm	2 × 4	400 × 400	GB	1 × 230V, 1 × RJ45	<b>98.459.XXX</b>

**Cabinets with 12 compartments and KEY Lock**

<b>1205 mm</b>	585 mm	3 × 4	400 × 400	D / PE	2 × 230V	<b>98.410.XXX</b>
<b>1205 mm</b>	585 mm	3 × 4	400 × 400	D / PE	1 × 230V, 2 × USB	<b>98.416.XXX</b>
<b>1205 mm</b>	585 mm	3 × 4	400 × 400	D / PE	1 × 230V, 1 × RJ45	<b>98.420.XXX</b>
<b>1205 mm</b>	585 mm	3 × 4	400 × 400	CH	2 × 230V	<b>98.412.XXX</b>
<b>1205 mm</b>	585 mm	3 × 4	400 × 400	CH	1 × 230V, 2 × USB	<b>98.630.XXX</b>
<b>1205 mm</b>	585 mm	3 × 4	400 × 400	CH	1 × 230V, 1 × RJ45	<b>98.632.XXX</b>
<b>1205 mm</b>	585 mm	3 × 4	400 × 400	F	2 × 230V	<b>98.414.XXX</b>
<b>1205 mm</b>	585 mm	3 × 4	400 × 400	F	1 × 230V, 2 × USB	<b>98.418.XXX</b>
<b>1205 mm</b>	585 mm	3 × 4	400 × 400	F	1 × 230V, 1 × RJ45	<b>98.422.XXX</b>
<b>1205 mm</b>	585 mm	3 × 4	400 × 400	GB	2 × 230V	<b>98.456.XXX</b>
<b>1205 mm</b>	585 mm	3 × 4	400 × 400	GB	1 × 230V, 2 × USB	<b>98.458.XXX</b>
<b>1205 mm</b>	585 mm	3 × 4	400 × 400	GB	1 × 230V, 1 × RJ45	<b>98.460.XXX</b>



**2 × socket, 230V**



**Socket 230V/RJ45, without network cable, Plug+Play, Cat6**



**Socket 230V/Power USB**

**>>** For power modules, see. p. 145

**i** **On request**  
Doors with viewing windows



**LISTA clothes lockers and laptop cabinets with power outlets are perfect for personal storage of battery-powered devices of all kinds**, whether in industry, trade, offices, schools, universities or public buildings. Batteries can be charged during storage thanks to the built-in sockets and are therefore always ready to use.

- + Utmost stability**  
thanks to hinged doors with the pin on the right and with reinforcement pocket for greater protection against burglary (DIN 4547)
- + Sophisticated ventilation**  
with air vents at the top and bottom of the housing
- + Optimum hygiene**  
thanks to plain compartment shelves without raised edge to make it easier to clean the compartments thoroughly
- + Practical interior fittings**  
with hat rack, towel holder and clothes rail with three sliding coat hooks for each compartment
- + Secure locking option**  
with KEY Lock locking system (CODE/RFID Lock and other locking systems on request)
- + Protection against corrosion**  
with base that is galvanised in addition to being powder-coated
- + Flexible range of applications**  
with charging options for battery-operated BDE devices, laptops, tablets or smartphones
- + Battery charging cabinet for electric scooters**  
with additional ramp in front of the base
- + Outstanding safety features**  
CE compliant

Art. no. **98.160.010**  
Pale blue, RAL 5012



Art. no. **98.166.010**  
Pale blue, RAL 5012

### Clothes lockers

The clothes lockers are equipped with the following for each compartment: Single-leaf solid sheet door, flush-fitting, smooth surface (1 compartment lockable), 1 hat shelf, 1 clothes rack with 3 sliding coat hooks, 1 towel holder, 2 × 230 V sockets.



**Cabinet width mm**

**500 mm**

compartment width

**300 mm**

**600**

**900**

Number of compartments

2

3

Door specification

plain

plain



**1800 mm**  
with base, 100 mm

Model

Modules per compartment



KEY Lock

Art. no.

Art. no.

D/Schuko

2 × 230V

KEY Lock

**98.156.XXX**

**98.158.XXX**

CH

2 × 230V

KEY Lock

**98.155.XXX**

**98.157.XXX**

F

2 × 230V

KEY Lock

**98.161.XXX**

**98.159.XXX**

GB

2 × 230V

KEY Lock

**98.162.XXX**

**98.160.XXX**

### E-scooter cabinets

The e-scooter cabinets are equipped with the following for each compartment: single-leaf solid sheet door, flush-fitting, perforated field for additional ventilation (1 compartment lockable), 1 hat shelf, 1 clothes rack with 3 sliding coat hooks, 1 velcro holder, 2 × 230 V sockets.



**1000 mm**



**500 mm**



**1700 mm**

Model

Number of compartments ×  
compartment width (mm)

Modules per  
compartment



KEY Lock

Art. no.

1000

500

1700

D/Schuko

2 × 500

2 × 230V

KEY Lock

**98.166.XXX**

1000

500

1700

CH

2 × 500

2 × 230V

KEY Lock

**98.167.XXX**

1000

500

1700

F

2 × 500

2 × 230V

KEY Lock

**98.168.XXX**

1000

500

1700

GB

2 × 500

2 × 230V

KEY Lock

**98.169.XXX**

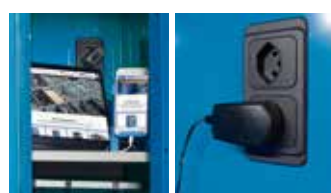

**Power modules for clothes lockers and e-scooter cabinets**



**Connecting cable**



**Clothes rack**



**Hook and loop fastener for e-scooter cabinet**



**Level, horizontally configured compartments make the LISTA laptop cabinet the optimal storage solution for notebooks and similar devices.**

They also feature a particularly effective space-saving design and can be equipped with various power modules and locking solutions to tailor them more flexibly to your requirements.

- 
- + Flexible range of applications**  
with charging options for laptops, tablets and smart-phones
  - + Sophisticated ventilation**  
optimal air circulation via rear air vents
  - + Secure locking option**  
Devices are locked away at all times and are protected against unauthorised use with intelligent locking systems such as CODE/RFID locks.
  - + Protects against dirt**  
thanks to substructure with base to prevent dirt from accumulating under the cabinet
  - + Outstanding safety features**  
CE compliant



Art. no. **98.416.070**  
Ruby red, RAL 3003

mm	mm	mm	No. of compartments	Shelf dimension (W x H mm)	Type	Module per compartment	Art. no.
<b>Laptop cabinets with 10 compartments and cylinder lock</b>							
415	500	1790	1 x 10	330 x 140	D / PE	1 x 230V	<b>98.600.XXX</b>
415	500	1790	1 x 10	330 x 140	D / PE	2 x 230V	<b>98.582.XXX</b>
415	500	1790	1 x 10	330 x 140	CH	1 x 230V	<b>98.597.XXX</b>
415	500	1790	1 x 10	330 x 140	CH	2 x 230V	<b>98.583.XXX</b>
415	500	1790	1 x 10	330 x 140	F	1 x 230V	<b>98.598.XXX</b>
415	500	1790	1 x 10	330 x 140	F	2 x 230V	<b>98.584.XXX</b>
415	500	1790	1 x 10	330 x 140	GB	1 x 230V	<b>98.599.XXX</b>
415	500	1790	1 x 10	330 x 140	GB	2 x 230V	<b>98.585.XXX</b>



**Power modules for laptop cabinet**

Socket strip can be ordered with one or two 230V sockets per compartment.



**USB adapter for sockets**

1 x USB-C connection, 3 x USB-A connection  
Overcharge, deep discharge, overload and short-circuit protection Colour: Black

Art. no. **61.257.000**



When ordering a laptop cabinet on this page with **CODE/RFID Lock**, please specify the suffix **"F"** in addition to the article number from the table (e.g. **98.600.XXX.F**)



Thanks to its high resistance to light and weathering, the LISTA e-bike charging station is ideally suited for the central supply of batteries for outdoor use. Each compartment has a power module with two fused sockets. In addition to business and public authorities, schools, universities, airports, restaurants, cafés, hotels and other public buildings can also be equipped with the e-bike charging station for outdoor use.

### + Utmost stability and convenience

thanks to welded sheet steel housing made of electrolytically galvanised sheet steel and double-walled doors with opening limiter and self-closing function

### + Well protected

thanks to high-quality polyester resin powder coating with high light and weather resistance, cabinet housing and electrical components protected against splashes (IP44 in accordance with DIN EN 60529), inclined top with front projection as rain protection

### + Perfect cable management

thanks to 230V socket with cover, FI/LS switch for each compartment, power supply via ground cable, access in base in spray water-protected distribution box (IP65), roof and left side panel removable as inspection opening (screwed), inspection opening in lower compartment incl. distributor box in base area

### + Sophisticated ventilation

thanks to integrated heat ventilation conduit and passive ventilation in each compartment

### + Outstanding safety features

CE compliant

### + Secure locking option

with security cylinder lock, coin deposit lock or cashier lock (other locking systems available on request)





Art. no. **61.200.495**  
Pale grey, RAL 7035

Art. no. **61.217.498**  
Pale grey, RAL 7035  
Pale blue, RAL 5012

Art. no. **61.218.499**  
Pale grey, RAL 7035  
Metallic grey, NCS S 6502-B



**Socket outlet**  
230V/16A with cover,  
FI/LS switch per compartment

**W** → 600 mm    **D** ↗ 500 mm    **H** ↑ 2059/2000 mm, with 200 mm base

Number of compartments    Shelf dimension (W × H mm)   

Art. no. D/PE    Art. no. CH    Art. no. F    Art. no. GB

**Battery charging cabinet as e-bike charging station**

Number of compartments	Shelf dimension (W × H mm)	Lock type	Art. no. D/PE	Art. no. CH	Art. no. F	Art. no. GB
1 × 4	370 × 370	Cylinder lock	61.200.XXX	61.217.XXX	61.218.XXX	on request
		Coin deposit lock	61.219.XXX	61.220.XXX	61.221.XXX	on request
		Cashier lock	61.222.XXX	61.223.XXX	61.224.XXX	on request

**Accessories for coin deposit lock and cashier lock**

Accessories	sales unit	Art. no.
<b>Armband</b> , nylon, colour: blue	10 items	97.608.000
<b>Numbered set</b> no. variable	50 tiles	11.696.000
<b>Promax removal key</b> , new system	1 key	96.340.000
<b>Cash box key</b> for cashier lock for emptying coin collecting box	1 key	98.179.000



**Cylinder lock**  
with 3 keys and key security card

**i Choice of colour**

The LISTA battery-charging cabinet for outdoor use is available in the following three colours (high-quality polyester resin powder paint). When ordering, please use the desired three-digit colour code (instead of XXX).



**.495** Pale grey  
RAL 7035

**.498** Pale grey  
RAL 7035  
Pale blue  
RAL 5012

**.499** Pale grey  
RAL 7035  
Metallic grey  
NCS S 6502-B

» Please contact us for more information



**Coin deposit lock**  
with door plate (without IP × 4 protection)



**Cashier lock**  
mechanical (without IP × 4 protection)

**LISTA environmental and oil cabinets are suitable for the safe and standard storage of water-hazardous substances in water hazard class (WGK) 1–3.** Liquids that are required in the daily work flow are stored safely in LISTA oil cabinets. Pull-out shelves hold the liquid canisters. Drops of liquid are collected in the drip tray.



- + Maximum stability**  
with housing load capacity of up to 500 kg
- + High load capacities**  
Drip trays with a load capacity of up to 100 kg and canister shelves up to 200 kg
- + Can be adapted to new storage items at any time**  
by inserting or converting drip trays and canister shelves in 25-mm increments as required
- + Individual equipment options**  
with drip trays, canister shelves, base trays, canisters and drawers
- + Safe and orderly storage**  
with drip trays welded to form a liquid-tight seal according to Section 19 of the Water Resources Act/German directive on steel trays (StawaR).
- + Secure locking**  
with solid-sheet doors (flush-fitting, folded from one piece) and selectable locking systems
- + Sophisticated ventilation**  
with perforated field at the top and bottom of environmental lockers





**Oil cabinet**  
Art. no. **71.461.010**  
Light blue, RAL 5012



**Environmental cabinet**  
Art. no. **60.474.030**  
Reseda green, RAL 6011

**Oil cabinets**

The cabinets are fitted with: chromium steel drip trays, 2 mm thick, welded to form a liquid-tight seal according to Section 19 of the Water Resources Act/German directive on steel trays (StawaR), 40-litre capacity, canister shelves (painted grey), NCS 4502-B, canister made of HDPE plastic with outlet valve (glossy chrome finish). Solid-sheet hinged doors folded from one piece, with fulcrum pins, 235-degree opening angle.

**W** → 717 mm    **D** ↗ 753 mm    **H** ↑ 1450 mm



**Cabinets with 2 solid sheet doors**

Equipment	kg	Door storage	Lock	Art.no.
2 canister shelves 8 canisters, 25 l each 1 drip tray Tank dimensions: 651×620×100 mm (W×D×H)	200	Fulcrum pin	KEY Lock	<b>71.460.XXX</b>
3 canister shelves 10 canisters, 10 l each 4 canisters, 25 l each 1 drip tray Tank dimensions: 651×620×100 mm (W×D×H)	200	Fulcrum pin	KEY Lock	<b>71.461.XXX</b>



**i Canister with outlet tap**

Fitted with screw cap. Filter in the filler neck. Outlet tap, glossy chrome finish with seal. Specification: HDPE plastic, transparent.

Width	Depth	Height	Volumetric capacity	Art.no.
120 mm	440 mm	270 mm	10 l	<b>14.990.000</b>
150 mm	440 mm	490 mm	25 l	<b>14.991.000</b>

**Environmental cabinets**

The cabinets are fitted with: galvanised drip trays, 3 mm thick, welded to form a liquid-tight seal according to Section 19 of the Water Resources Act/German directive on steel trays (StawaR), 20-litre capacity. Solid-sheet hinged doors folded from one piece, with hinges, 115-degree opening angle.

**W** → 1000 mm    **D** ↗ 500 mm    **H** ↑ 1950 mm



**Cabinet with 2 solid sheet doors**

Equipment	kg	Door storage	Lock	Art.no.
4 drip trays Tank dimensions: 982×445×70 mm (W×D×H)	100	Hinge	KEY Lock	<b>60.474.XXX</b>



**Observe legal regulations and directives**

The canisters may only be filled with acid- and lye-free liquids (no abrasive media), oils and grease with a flame point above 55° Celsius. Maximum ambient temperature 40° Celsius. Please call us for special applications and further information.

**i Note:**  
Not suitable for storage of flammable materials



**Canister shelf**

The canister shelf has a handle on the left and right and a centre lip. It is only 27 E (451 mm) deep so there is enough room in the front area for the canister tap.



**Built-under drainage tray for oil cabinet**

The built-under drainage tray of the oil cabinet has a leak-proof welded construction according to the Water Resources Act Sec. 19/StawaR (German directive on steel trays) and has a test certificate. It has a volumetric capacity of 40 l. Art. no. **14.995.000**



**Drip trays**

The drip trays feature a leak-proof welded construction according to StawaR (German directive on steel trays) and have a test certificate.



# VERSATILE AND ROBUST

**Whether for files, liquids, equipment or tools: shelving systems from LISTA offer tailor-made storage solutions for practically all requirements.** High load capacities and a distinctly robust design guarantee optimum use of space and high storage capacity. Many shelving systems are now also available in a galvanised version. The more impressive new feature is that the universal shelving system has been completely overhauled to allow even more flexible solutions for a wide variety of working environments.



# The right solution for every need



**L1006 universal shelving**  
see p. 220



**Heavy-duty pull-out shelving systems**  
see p. 238



**Drawer storage walls**  
see p. 84



**Sliding shelf units\***



**Storage and sloping shelving systems\***



**Wide span shelving systems\***



**Pallet shelving systems\***



**Cantilever shelving systems\***



**Mobile shelving systems**  
see p. 246

\* For more information, please get in touch.

**The impressive feature of the universal shelving system from LISTA is that it is fully modular.** Available in two versions – either with shelf supports or with open sides – and a variety of heights, depths and unit widths, the slot-in system is quick and easy to assemble for a wide range of requirements. Individual configuration options with shelves, partitions, drawer units and more produce an orderly, space-saving storage system in which everything is ready to hand. Whether small parts, bulk goods, tools or archive material: the LISTA universal shelving system is the ideal warehouse solution – especially in the lean area.

## ! ALWAYS WITH LISTA

### Choice of colours

12 standard colours, all other colours available; see p. 22. Many shelving systems are also available in a galvanised version.

### Intelligent locking systems

Replaceable cylinders that can be fitted to existing locking systems, electronic locking systems via CODE and RFID Lock for absolute security made to measure; see p. 28.

### Individual configuration options

in size, equipment, locking system, colour and drawer partitions; see p. 10.

### Fully combinable

Standardised dimensions for all LISTA universal shelving systems of varying designs.



**+ Utmost stability**

Sturdy shelf supports or side panels with a load capacity from 1,000 kg to 2,800 kg per shelving unit

**+ High load capacities**

80 kg to 350 kg per shelf

**+ Generous storage capacity in a small space**

Can also be installed as a double-stack set-up on request

**+ Fast and easy assembly**

Non-screwed, slot-together design of all basic components and shelves simplifies assembly

**+ Flexible configuration options**

Drawers, clothes rails, organisation rails, pull-out suspension file frames, shelf front cover strips, drip trays, grating covers, etc.

**+ Fully modular**

Standardised dimensions for all LISTA universal shelving units and customisable configuration options

**+ Can be adapted to new storage items at any time**

Flexible integration and rearrangement of shelves, drawers and individual parts in increments of 25 mm

**+ Secure locking**

Choice of hinged doors or space-saving sliding doors in combination with rear panels

**+ Ideally suited to lean environments**

Perforated rear and side panel covers and sloping shelves for fast, ergonomic access to tools and materials

**+ Maximum shelf use**

Shelves have an edging height of only 25 mm so that the full storage height is available

## + Fully modular and available in a wide range of versions

All individual parts and accessories of the universal shelving system can be freely positioned and combined with one another in a modular fashion – and this applies to both equipment versions (with shelf supports or with side panel).

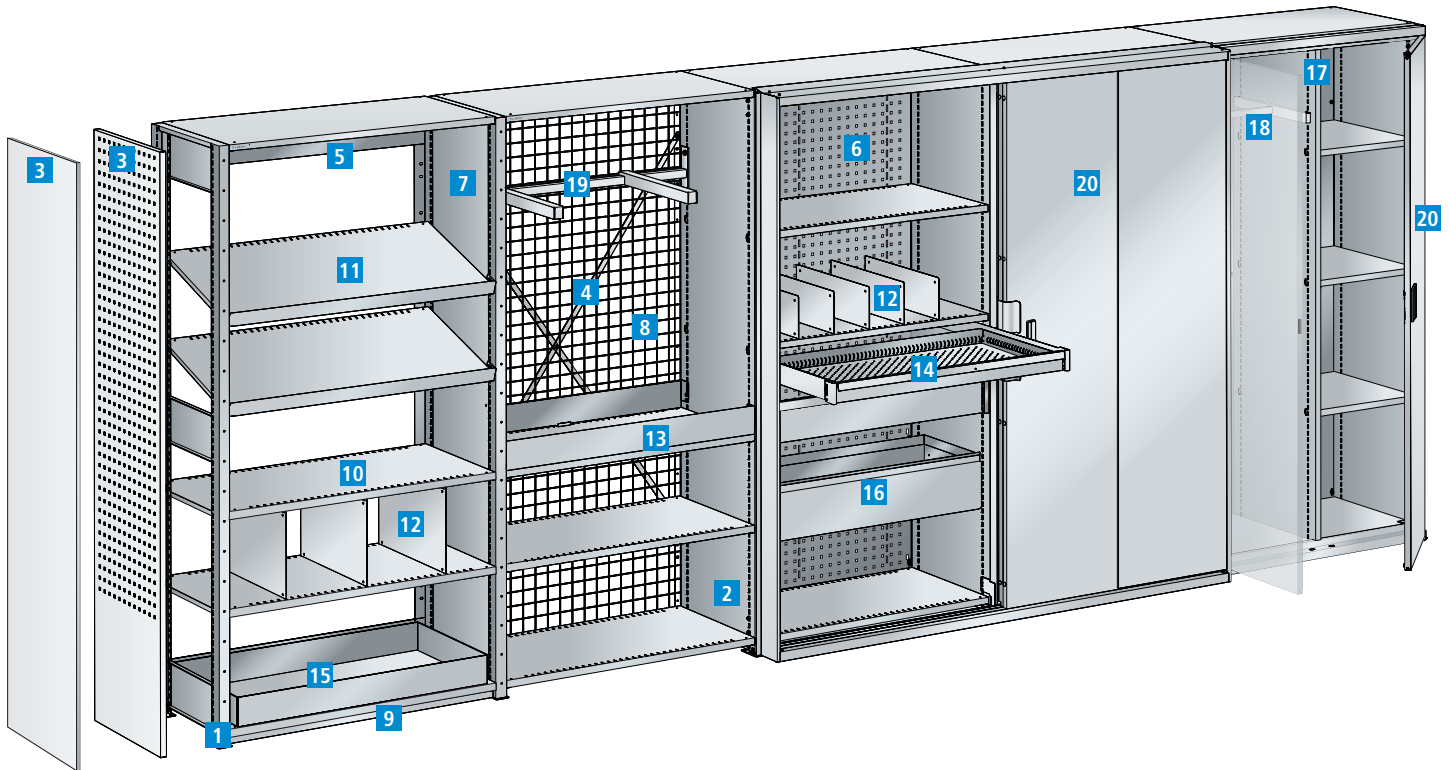

» Dimensions and load capacities, see page 226.

### 1 Shelf supports

Sturdy, open layout with a maximum load per unit of 2,800 kg, optional extension unit for shelving heights up to 5 m.

### 2 Side panel

Elegant closed layout with a maximum load per unit of 1,000 kg also prevents the stored items from falling out

### 3 Side panel cover, plain or perforated

For covering the open shelf supports or the row of slots on the side panels, perforated version for tool hooks

### 4 Diagonal brace

For stabilising the shelving units lengthwise

### 5 Lengthwise braces

Used instead of diagonal braces to make both sides accessible

### 6 Rear panel, plain or perforated

For covering the rear panel of shelving units; also stabilises the units lengthwise, perforated version for tool hooks

### 7 Partition

Placed between the shelf supports

### 8 Grating

Can be used as side panel covers, rear panels and partitions, prevents access and yet guarantees visibility and ventilation

### 9 Base cover

Protects against dust and dirt. Also prevents items from sliding underneath the unit

### 10 Shelf

High compartment loads of 80 to 350 kg (edge height 25 mm) for maximum use of space, in a choice of plain or slotted

### 11 Sloping shelf LEAN

Retrofittable stop bars for fitting shelves at an incline, for providing ergonomic access to materials and parts

### 12 Partitions and shelf dividers

For subdividing slotted shelves, ideal for storing small parts and small boxes

### 13 Shelf front cover strip

For the neat and tidy storage of bulk goods

### 14 Drawer

Fully extendable with load capacity of 50 kg for space-saving storage of small parts; extensive range of partition material

### 15 Drip tray

For storing liquids and for use as a drip tray

### 16 Pull-out suspension filing frame

Suitable for A4 suspension files; load capacity 50 kg for the orderly storage of and easy access to suspension files

### 17 Centre partition

For the vertical subdivision of complete shelf units

### 18 Clothes rail

Perfect for storing clothing and protective workwear

### 19 Organising rail

For vertical storage, compartment division and for storing ring-shaped materials (cables, vee belts and tubing)

### 20 Hinged and sliding doors

Secure access and dust protection with hinged doors or space-saving sliding doors, lockable

## + Flexible range of applications

The universal shelf unit offers storage solutions for a wide variety of requirements in workshops and offices. Since it takes ergonomic factors into account and implements the 5S principles, it is especially suitable for lean working environments.



### Storage of tools and spare parts

- Perfect order and cleanliness according to the 5S principle



### Storage of boxes and containers

- Ergonomic access to materials at the workplace according to lean criteria



### Storage of bulk goods

- Structured and efficient storage of bulk goods



### Shelf units with sloping shelves

- Ergonomic access to materials at the workplace



### Shelf cabinet system with lockable doors and drawers

- Safekeeping of small parts and tools



### Storage of lever-arch files, folders and suspension files

- Well-organized and within reach



### Clothing locker shelf units

- Storage of clothing and protective workwear



### Double-stack shelving systems

- Optimum use of space

## + Individual configuration options

### Typical configurations



**L1006 universal shelf unit for the workshop**

- Perforated rear panel for holding tool hooks
- Drawers for safekeeping of small parts
- Shelf front cover strips for tidy storage of loose bulk goods
- Organising rail for storing cables and tubing
- Tyre shelves for storing narrow and wide wheels



## Configure and order L1006 universal shelving individually



**Shelf unit floor area**

- Choice of shelf dimensions  $W \times D$  (e.g.:  $1000 \times 500$  mm)
- To calculate the external dimension, please refer to the planning instructions on p. 226 / 227



**1. Layout and shelving height**

- Choice of "shelf supports" or "side panel".  
**Design combinations available on request!**
- Choice of shelving height H
- Optional: shelf support cover, extension units, side panel covers and partitions, floor anchoring, levelling plates



**2. Stabilising elements**

- Choice of stabilising elements: diagonal braces, rear panels or lengthwise braces





### L1006 universal shelf unit for the office

- Elegant, closed side panel
- Pull-out suspension filing frame for orderly, easily accessible suspension files
- Partitions for orderly storage of and easy access to files and folders
- Shelves with an edging height of only 25 mm so that the full height of a file is available

**!** **NEW!**  
Shelf heights 1,100mm, 1,450 mm and 1,800 mm for 3, 4 or 5 file heights

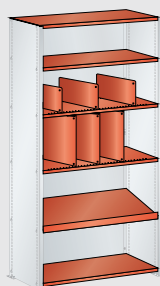

#### 3. Shelves

- Choice of shelves (plain, slotted) and compartment load
- Optional: Stop bars for sloping shelves, shelf labelling, partitions and dividers

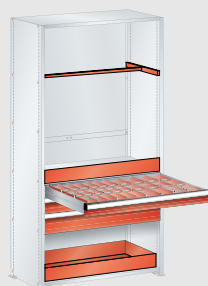

#### 4. Accessories

- Optional: Choice of accessory shelf front cover strips, drawers, partition material, drip trays, clothes rails, Cover panels, etc.
- Choice of tyre compartment level pair for tyre storage, see p. 235



#### 5. Front-mounting fitments

- Optional: Hinged and sliding doors

#### 6. Add-on elements "Office"

- Optional: sideboard

# Shelving systems | Universal shelf unit L1006, shelf support layout

## Dimensions and load capacities

**kg** Max. load per unit 2,800 kg with a distance between shelves of max. 750 mm

**kg** Max. compartment load: 80, 160, 220, 280, 350 kg

Adjustment increment: 25 mm

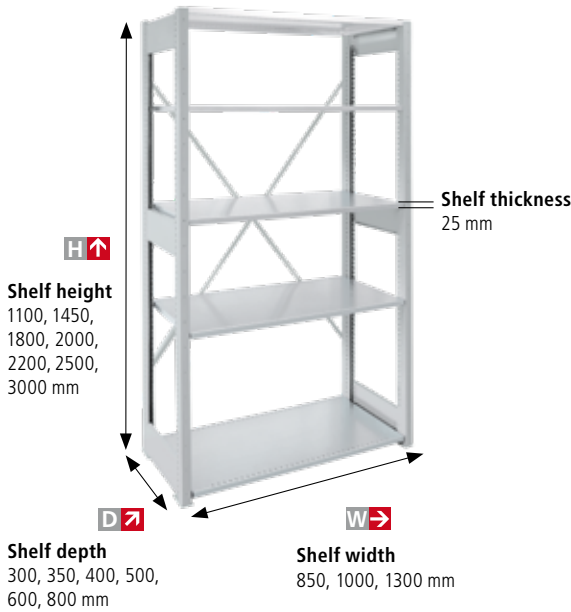

## Planning instructions

### Calculating the external dimensions

Overall width of shelving: Total shelving widths + number of supports × 40 mm + 10 mm (base plate external)

Overall depth of shelving: Shelf depth + 4 mm

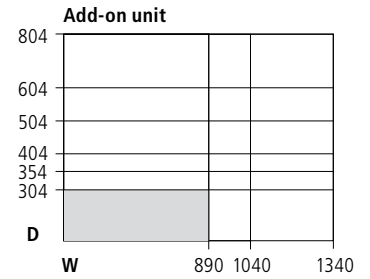
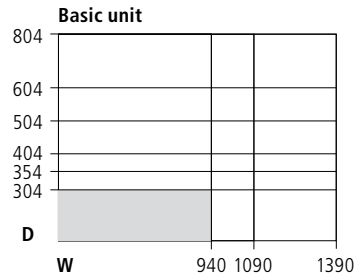

### Safety instructions

**Anchoring rule** Units with a depth to height ratio greater than 1:5 (1:4 for units with hinged doors and single units with drawers) must be anchored. Floor anchoring: Art. no. **130.555.000** (each).

**Arrangement of diagonal braces** For each basic unit and for each third add-on unit, an extra diagonal brace is required. Instead of diagonal braces, rear panels can be used – or lengthwise braces in order to make the unit accessible from both sides. Diagonal brace: Art. no. **50.026.000**.

## Basic and add-on shelf units

### Basic unit

2 pairs of shelf supports incl.  
6 horizontal braces  
1 diagonal brace, galvanised  
5-6 shelves, slotted (thickness 25 mm)

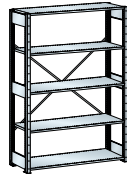

### Add-on unit

1 pair of shelf supports, incl.  
3 horizontal braces  
5-6 shelves, slotted (thickness 25 mm)

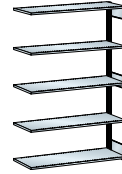

				<b>D</b> 400 mm		500 mm		600 mm	
<b>H</b>	<b>W</b>	Number of shelves	Shelf load <b>kg</b>	Basic unit Art. no.	Add-on unit Art. no.	Basic unit Art. no.	Add-on unit Art. no.	Basic unit Art. no.	Add-on unit Art. no.
2000	1000	5	160	50.200.XXX	50.201.XXX	50.202.XXX	50.203.XXX	50.204.XXX	50.205.XXX
			220	50.236.XXX	50.237.XXX	50.238.XXX	50.239.XXX	50.240.XXX	50.241.XXX
2000	1300	5	160	50.206.XXX	50.207.XXX	50.208.XXX	50.209.XXX	50.210.XXX	50.211.XXX
			220	50.242.XXX	50.243.XXX	50.244.XXX	50.245.XXX	50.246.XXX	50.247.XXX
2200	1000	5	160	50.212.XXX	50.213.XXX	50.214.XXX	50.215.XXX	50.216.XXX	50.217.XXX
			220	50.248.XXX	50.249.XXX	50.250.XXX	50.251.XXX	50.252.XXX	50.253.XXX
2200	1300	5	160	50.218.XXX	50.219.XXX	50.220.XXX	50.221.XXX	50.222.XXX	50.223.XXX
			220	50.254.XXX	50.255.XXX	50.256.XXX	50.257.XXX	50.258.XXX	50.259.XXX
2500	1000	6	160	50.224.XXX	50.225.XXX	50.226.XXX	50.227.XXX	50.228.XXX	50.229.XXX
			220	50.260.XXX	50.261.XXX	50.262.XXX	50.263.XXX	50.264.XXX	50.265.XXX
2500	1300	6	160	50.230.XXX	50.231.XXX	50.232.XXX	50.233.XXX	50.234.XXX	50.235.XXX
			220	50.272.XXX	50.273.XXX	50.280.XXX	50.281.XXX	50.288.XXX	50.289.XXX



## Dimensions and load capacities

- Max. load per unit 1,000 kg
- Max. compartment load: 80, 160, 220, 280 kg
- Adjustment increment: 25 mm

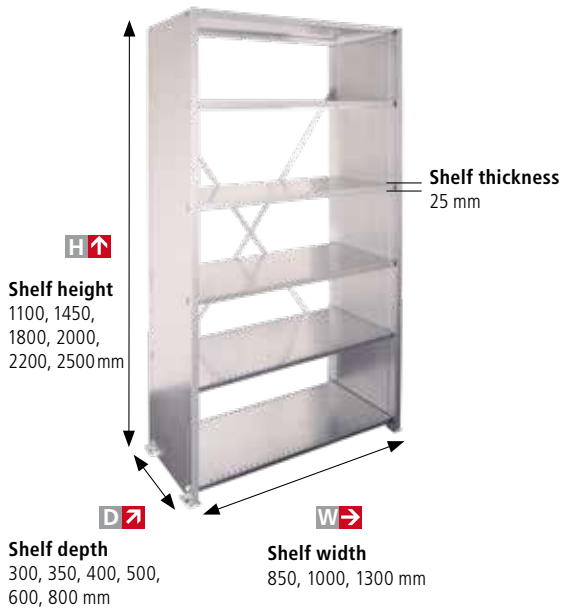

## Planning instructions

### Calculating the external dimensions

- Overall width of shelving: Total shelf widths + 50 mm (base plate external)
- Overall depth of shelving: Shelf depth + 36 mm

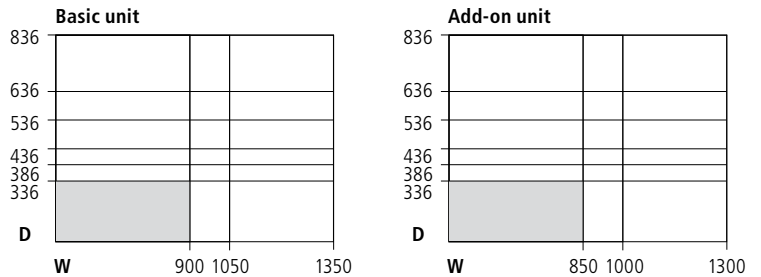

### Max. base and extension section per shelving unit

Shelf spacing (mm)	150	300	450	600	max. 750
Permissible section load with diagonals or longitudinal connectors (kg)	max. 800	max. 770	max. 750	max. 710	max. 680
Permissible section load with rear panels (kg)	max. 1050	max. 1000	max. 950	max. 900	max. 850

**!** The load data apply only for uniformly distributed load! Please observe the safety instructions on page 226.

## Basic and add-on shelf units

### Compartment load 80 or 160 kg, galvanised or painted

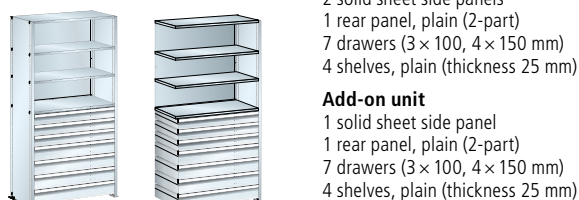
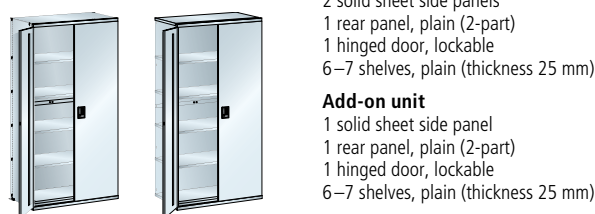
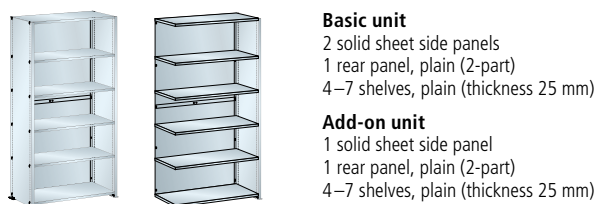
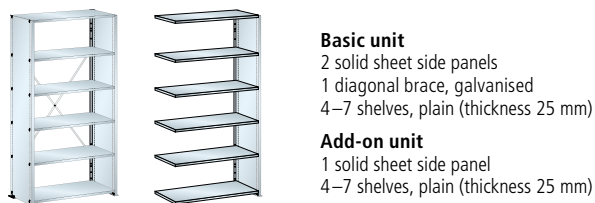







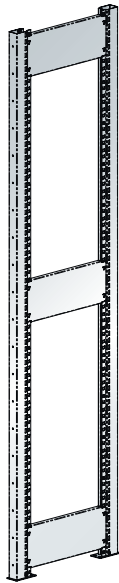

	Number of shelves	1000 x 350 mm		1000 x 500 mm	
		Compartment load 80 kg		Compartment load 160 kg	
mm		Basic unit	Add-on unit	Basic unit	Add-on unit
1100	4	Art. no. 45.919.XXX	Art. no. 45.928.XXX	-	-
1450	5	Art. no. 45.922.XXX	Art. no. 45.931.XXX	-	-
1800	6	Art. no. 45.925.XXX	Art. no. 45.934.XXX	-	-
2000	6	Art. no. 50.300.XXX	Art. no. 50.301.XXX	Art. no. 50.302.XXX	Art. no. 50.303.XXX
2200	7	Art. no. 50.304.XXX	Art. no. 50.305.XXX	Art. no. 50.306.XXX	Art. no. 50.307.XXX
1100	4	Art. no. 45.955.XXX	Art. no. 45.964.XXX	-	-
1450	5	Art. no. 45.958.XXX	Art. no. 45.967.XXX	-	-
1800	6	Art. no. 45.961.XXX	Art. no. 45.970.XXX	-	-
2000	6	Art. no. 50.308.XXX	Art. no. 50.309.XXX	Art. no. 50.405.XXX	Art. no. 50.406.XXX
2200	7	Art. no. 50.407.XXX	Art. no. 50.408.XXX	Art. no. 50.409.XXX	Art. no. 50.410.XXX
2000	6	Art. no. 50.411.XXX	Art. no. 50.412.XXX	Art. no. 50.413.XXX	Art. no. 50.414.XXX
2200	7	Art. no. 50.415.XXX	Art. no. 50.416.XXX	Art. no. 50.417.XXX	Art. no. 50.418.XXX
2000	4	-	-	Art. no. 50.419.XXX	Art. no. 50.420.XXX
2200	4	-	-	Art. no. 50.421.XXX	Art. no. 50.422.XXX

## 1a. Pair of shelf supports Max. load per unit, 2,800 kg

Consisting of 2 shelf supports, 2 base plates and 3 horizontal braces (4 horizontal braces for height of 3000 mm). Slots 25 mm apart for attaching shelf supports at any height, including fastening material. Specification: Shelf supports in cold-rolled C profile, 40 x 75 mm, with 6 edge turns for maximum stability. Base plate, galvanised. Without Floor anchoring. Colour: As per colour chart or galvanised.



	300	350	400	500	600	800
	Art. no. 	Art. no. 	Art. no. 	Art. no. 	Art. no. 	Art. no. 
1100	45.680.XXX	45.681.XXX	45.682.XXX	46.380.XXX	46.381.XXX	46.382.XXX
1450	45.683.XXX	45.684.XXX	45.685.XXX	46.383.XXX	46.384.XXX	46.385.XXX
1800	45.686.XXX	45.687.XXX	45.688.XXX	45.689.XXX	45.690.XXX	45.691.XXX
2000	50.000.XXX	50.001.XXX	50.002.XXX	50.003.XXX	50.004.XXX	50.005.XXX
2200	50.516.XXX	50.517.XXX	50.518.XXX	50.519.XXX	50.520.XXX	50.521.XXX
2500	50.006.XXX	50.007.XXX	50.008.XXX	50.009.XXX	50.010.XXX	50.011.XXX
3000	45.692.XXX	45.693.XXX	45.694.XXX	45.695.XXX	45.696.XXX	45.697.XXX
Dimensions (W x D) mm	40 x 304	40 x 354	40 x 404	40 x 504	40 x 604	40 x 804

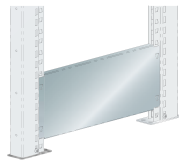

### Additional horizontal braces

Specification: Steel sheet. Colour: As per colour chart or galvanised.

Art. no. 	Art. no. 	Art. no. 	Art. no. 	Art. no. 	Art. no. 
45.510.XXX	45.511.XXX	45.512.XXX	45.513.XXX	45.514.XXX	45.515.XXX

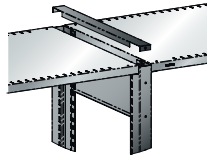

### Shelf support cover

For covering the top of shelf supports. Specification: Steel sheet. Colour: As per colour chart or galvanised.

Art. no. 	Art. no. 	Art. no. 	Art. no. 	Art. no. 	Art. no. 
50.510.XXX	50.511.XXX	50.512.XXX	50.513.XXX	50.514.XXX	50.515.XXX



### Intermediate fill-in strip

To close off intermediate spaces when shelves are at the same height. Not suitable for use with partitions. Description: sheet steel. Colour: according to colour chart or galvanised.

Art. no. 	Art. no. 	Art. no. 	Art. no. 	Art. no. 	Art. no. 
45.810.XXX	45.811.XXX	45.812.XXX	45.813.XXX	45.814.XXX	45.815.XXX

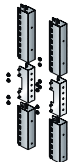

### Extension unit, per pair of shelf supports

For shelving heights up to 5 m including fastening material. The static calculations for the extension will be carried out by LISTA's specialists. Specification: Galvanised.

Art. no.  
50.484.000

 Levelling plates and floor anchoring on page 229.



**1b. Solid sheet side panel** **Max. load per unit 1,000 kg**

Standard with triangular folded reinforcing at the front. Slots 25 mm apart for attaching shelf supports. Including base plate set, galvanised. Specification: Steel sheet. Without Floor anchoring. Colour: As per colour chart or galvanised.



**!** Side panel with T-edging for add-on units with rear panels.

		300	350	400	500	600	800
		Art. no.	Art. no.	Art. no.	Art. no.	Art. no.	Art. no.
1100	Standard	45.607.XXX	45.608.XXX	45.609.XXX	46.386.XXX	46.387.XXX	46.388.XXX
	T-edging	45.637.XXX	45.638.XXX	45.639.XXX	46.395.XXX	46.396.XXX	46.397.XXX
1450	Standard	45.610.XXX	45.611.XXX	45.612.XXX	46.389.XXX	46.390.XXX	46.391.XXX
	T-edging	45.640.XXX	45.641.XXX	45.642.XXX	46.398.XXX	46.399.XXX	46.400.XXX
1800	Standard	45.613.XXX	45.614.XXX	45.615.XXX	46.392.XXX	46.393.XXX	46.394.XXX
	T-edging	45.643.XXX	45.644.XXX	45.645.XXX	46.401.XXX	46.402.XXX	46.403.XXX
2000	Standard	50.193.XXX	50.194.XXX	50.195.XXX	50.196.XXX	50.197.XXX	50.198.XXX
	T-edging	50.534.XXX	50.535.XXX	50.536.XXX	50.537.XXX	50.538.XXX	50.539.XXX
2200	Standard	50.522.XXX	50.523.XXX	50.524.XXX	50.525.XXX	50.526.XXX	50.527.XXX
	T-edging	50.540.XXX	50.541.XXX	50.542.XXX	50.543.XXX	50.544.XXX	50.545.XXX
2500	Standard	50.528.XXX	50.529.XXX	50.530.XXX	50.531.XXX	50.532.XXX	50.533.XXX
	T-edging	50.546.XXX	50.547.XXX	50.548.XXX	50.549.XXX	50.550.XXX	50.024.XXX
Dimensions (W x D) mm		30 x 336	30 x 386	30 x 436	30 x 536	30 x 636	30 x 836

**!** **NEW!**  
Shelf heights 1,100mm, 1,450mm and 1,800mm for 3, 4 or 5 file heights

**!** **Adapter side panel with T-edging** for combining depth 350 with 500 mm including 2 shelf supports

	500
	Art. no.
2000	50.032.XXX
2200	50.033.XXX
2500	50.034.XXX
Dimensions (W x D) mm	
	30 x 536

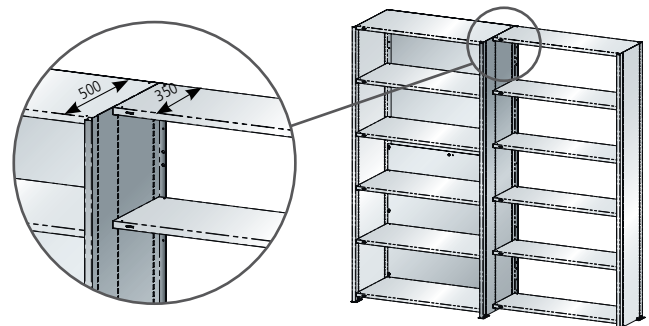

**Shelf supports for additional shelves**

For the adapter side panel with T-edge, special shelf supports are required if shelves at the same height are used next to one another. Two of these are required for each shelf.

Art. no. **45.739.000**  
10 pieces

**Levelling plates, 50 x 100 mm**

To compensate for height. Enable units to be aligned with precision on uneven floors. Specification: PVC. Colour: Grey.

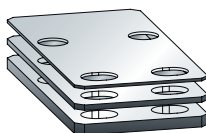

Art. no.	Thickness 1 mm	Thickness 2 mm	Thickness 4 mm
	<b>50.481.000</b>	<b>50.482.000</b>	<b>50.483.000</b>

**Floor anchoring**

Please follow the assembly instructions provided. For single shelf units, 2 per side panel or 2 per pair of shelf supports.

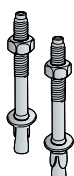

**Floor anchor** Art. no. **50.299.000**  
M8 x 80, each

**!** Please observe the safety instructions on page 226.



# Shelving systems | Universal shelving L1006, single components

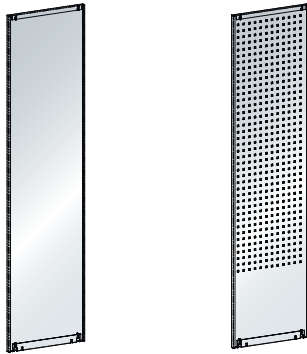

## Side panel cover, plain or perforated

Add-on panel for covering the shelf supports or the rows of slots in the solid sheet side panels. Can be attached left or right. For perforated side panel cover: 10 × 10 mm square holes and 38 mm divisions for holding keyhole hooks. Specification: Steel sheet, 2-part for height 3000 mm (1000 + 2000 mm). Colour: As per colour chart or galvanised.

		300	350	400	500	600	800
<b>D</b> ↗							
<b>H</b> ↑		Art. no. 🌈	Art. no. 🌈	Art. no. 🌈	Art. no. 🌈	Art. no. 🌈	Art. no. 🌈
1100	Plain	45.616.XXX	45.617.XXX	45.618.XXX	46.404.XXX	46.405.XXX	46.406.XXX
	Plain, per pair*	-	45.890.XXX	45.894.XXX	-	-	-
1450	Plain	45.619.XXX	45.620.XXX	45.621.XXX	46.407.XXX	46.408.XXX	46.409.XXX
	Plain, per pair*	-	45.891.XXX	45.895.XXX	-	-	-
1800	Plain	45.622.XXX	45.623.XXX	45.624.XXX	45.646.XXX	45.647.XXX	45.648.XXX
	Plain, per pair*	-	45.892.XXX	45.896.XXX	-	-	-
2000	Plain	50.012.XXX	50.013.XXX	50.014.XXX	50.015.XXX	50.016.XXX	50.017.XXX
	Plain, per pair*	-	45.893.XXX	45.897.XXX	-	-	-
	Perforated	50.337.XXX	50.338.XXX	50.339.XXX	50.340.XXX	50.341.XXX	50.342.XXX
2200	Plain	50.331.XXX	50.332.XXX	50.333.XXX	50.334.XXX	50.335.XXX	50.336.XXX
	Perforated	50.343.XXX	50.344.XXX	50.345.XXX	50.346.XXX	50.347.XXX	50.348.XXX
2500	Plain	50.018.XXX	50.019.XXX	50.020.XXX	50.021.XXX	50.022.XXX	50.023.XXX
	Perforated	50.349.XXX	50.350.XXX	50.351.XXX	50.352.XXX	50.353.XXX	50.354.XXX
3000	Plain	45.820.XXX	45.821.XXX	45.822.XXX	45.823.XXX	45.824.XXX	45.825.XXX
	Perforated	45.826.XXX	45.827.XXX	45.828.XXX	45.829.XXX	45.830.XXX	45.831.XXX
Dimensions (W) mm		21	21	21	21	21	21

\*Filler panels (left and right) for covering the rows of slots in the side panels and for flush closure with the front triangular edging of the side panels.

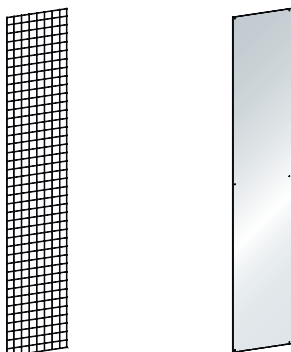

## Grating cover, side panel cover or partition (plain) for shelf supports

Side panel grating cover: The gratings are clamped in place by the shelf supports and shelves. Can also be used as partition. Specification: Steel wire 3.0 mm, mesh size 50 × 50 mm, galvanised, blue chromated according to DIN 50961. Partition (plain): Is placed between the shelf supports and held in place by the shelves. Specification: Steel sheet, 2-part for height 3000 mm (1000 + 2000 mm). Colour: As per colour chart or galvanised.

		300	350	400	500	600	800
<b>D</b> ↗							
<b>H</b> ↑		Art. no. 🌈	Art. no. 🌈	Art. no. 🌈	Art. no. 🌈	Art. no. 🌈	Art. no. 🌈
2000	Grating	50.387.000	50.388.000	50.389.000	50.390.000	50.391.000	50.392.000
	Plain	50.375.XXX	50.376.XXX	50.310.XXX	50.311.XXX	50.312.XXX	50.377.XXX
2200	Grating	50.393.000	50.394.000	50.395.000	50.396.000	50.397.000	50.398.000
	Plain	50.378.XXX	50.379.XXX	50.380.XXX	50.381.XXX	50.382.XXX	50.383.XXX
2500	Grating	50.399.000	50.400.000	50.401.000	50.402.000	50.403.000	50.404.000
	Plain	50.384.XXX	50.385.XXX	50.313.XXX	50.314.XXX	50.315.XXX	50.386.XXX
3000	Grating	45.832.000	45.833.000	45.834.000	45.835.000	45.836.000	45.837.000
	Plain	45.838.XXX	45.839.XXX	45.840.XXX	45.841.XXX	45.842.XXX	45.843.XXX
Dimensions (W) mm		3	3	3	3	3	3

## Base covers

Protects against dust and dirt. The base covers rest on the base plates and are hooked into the shelf supports or side panels by shelf supports. Including fastening material. Specification: Steel sheet. Colour: as per colour chart, **not available in galvanised version.**

		850	1000	1300
<b>W</b> →				
<b>H</b> ↑		Art. no.	Art. no.	Art. no.
25 mm		50.432.XXX	50.433.XXX	50.434.XXX



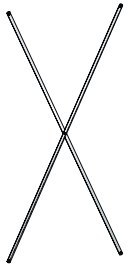

## 2. Diagonal brace

For stabilising the shelving units lengthwise. Fastening material included. Specification: Steel, galvanised.

### Diagonal brace arrangement:

For each basic unit and for every third add-on unit, an extra diagonal brace is required.

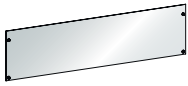

## Lengthwise braces

Instead of diagonal braces, lengthwise braces (at the top and bottom) can be used in order to make the unit accessible from both sides.

Including fastening material.

Specification: Steel sheet.

Colour: As per colour chart or galvanised.

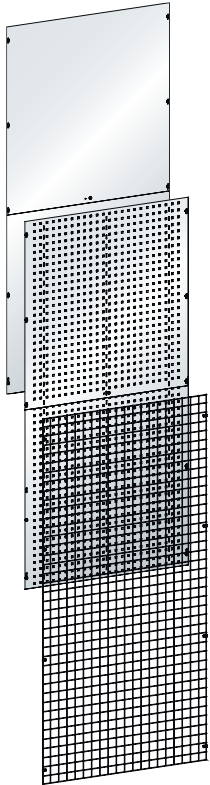

## Rear panels, plain or perforated

The rear panel cover for shelving sections also stabilises the units lengthwise and is screwed to the shelf supports or side panels.

For perforated rear panel: Specification: 10 × 10 mm square holes and 38 mm divisions for holding keyhole hooks (see page 163). Including fastening material.

Specification: 2-part, sheet steel.

Colour: As per colour chart or galvanised.

## Rear grating

Rear grating filling for shelf units. The rear gratings are screwed to the shelf supports or side panels. Including fastening material. Specification: Steel wire 3.0 mm.

Mesh size 50 × 50 mm, galvanised, blue chromated according to DIN 50961.

**!** To stabilise the shelving systems lengthwise, diagonal or lengthwise braces must be used in addition to the perforated rear panel.

**!** **Rear panel link piece** is absolutely essential for all rear panels used in combination with shelf supports. Basic unit: 2 × width 80 mm and for each add-on unit 1 × width 120 mm. Specification: Steel sheet. Colour: As per colour chart or galvanised.



H ↑	W →	Model	Art. no.
1100–1450	850–1000	for shelf supports and solid sheet side panel	<b>45.655.000</b>
1100–1450	1300	for shelf supports	<b>327.795.000</b>
1100–1450	1300	for solid sheet side panel	<b>344.289.000</b>
1800–2500	850–1300	for shelf supports and solid sheet side panel	<b>50.026.000</b>
3000	850–1300	for shelf supports and solid sheet side panel	<b>45.844.000</b>

W →	850	1000	1300
version	Art. no.	Art. no.	Art. no.
For shelf supports, per pair, height 185 mm	<b>50.319.XXX</b>	<b>50.320.XXX</b>	<b>50.321.XXX</b>
For solid sheet side panel, per pair, height 185 mm	<b>50.322.XXX</b>	<b>50.323.XXX</b>	<b>50.324.XXX</b>

W →	850	1000	1300
H ↑	Art. no.	Art. no.	Art. no.
1100 Plain	<b>45.600.XXX</b>	<b>45.601.XXX</b>	<b>46.410.XXX</b>
1450 Plain	<b>45.602.XXX</b>	<b>45.603.XXX</b>	<b>46.411.XXX</b>
1800 Plain	<b>45.604.XXX</b>	<b>45.605.XXX</b>	<b>45.606.XXX</b>
2000 Plain	<b>50.355.XXX</b>	<b>50.027.XXX</b>	<b>50.029.XXX</b>
Perforated	<b>50.360.XXX</b>	<b>50.361.XXX</b>	<b>50.362.XXX</b>
Grating	<b>50.423.000</b>	<b>50.424.000</b>	<b>50.425.000</b>
2200 Plain	<b>50.356.XXX</b>	<b>50.357.XXX</b>	<b>50.358.XXX</b>
Perforated	<b>50.363.XXX</b>	<b>50.364.XXX</b>	<b>50.365.XXX</b>
Grating	<b>50.426.000</b>	<b>50.427.000</b>	<b>50.428.000</b>
2500 Plain	<b>50.359.XXX</b>	<b>50.028.XXX</b>	<b>50.030.XXX</b>
Perforated	<b>50.366.XXX</b>	<b>50.367.XXX</b>	<b>50.368.XXX</b>
Grating	<b>50.429.000</b>	<b>50.430.000</b>	<b>50.431.000</b>
3000 Plain	<b>45.845.XXX</b>	<b>45.846.XXX</b>	<b>45.847.XXX</b>
Perforated	<b>45.848.XXX</b>	<b>45.849.XXX</b>	<b>45.850.XXX</b>
Grating	<b>45.851.000</b>	<b>45.852.000</b>	<b>45.853.000</b>

W →	80	120
H ↑	Art. no.	Art. no.
1100	<b>45.649.XXX</b>	<b>45.650.XXX</b>
1450	<b>45.651.XXX</b>	<b>45.652.XXX</b>
1800	<b>45.653.XXX</b>	<b>45.654.XXX</b>
2000	<b>50.369.XXX</b>	<b>50.370.XXX</b>
2200	<b>50.371.XXX</b>	<b>50.372.XXX</b>
2500	<b>50.373.XXX</b>	<b>50.374.XXX</b>
3000	<b>45.854.XXX</b>	<b>45.855.XXX</b>









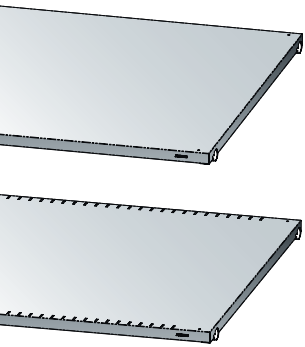



# Shelving systems | Universal shelving L1006, single components

## 3 Shelves, plain or slotted Max. compartment load 80, 160, 220, 280 and 350 kg

Including floor anchor. Shelf thickness 25 mm. Specification: Steel sheet. Colour: As per colour chart or galvanised.



				300	350	400	500	600	800	
	Shelf load 	Art. no. 		Art. no. 	Art. no. 	Art. no. 	Art. no. 	Art. no. 		
850	80	Plain		50.035.XXX	50.036.XXX	50.038.XXX	-	-	-	
		Slotted		50.080.XXX	50.081.XXX	50.083.XXX	-	-	-	
	160	Plain		55.737.XXX	50.037.XXX	50.039.XXX	50.041.XXX	50.044.XXX	50.047.XXX	
		Slotted		55.738.XXX	50.082.XXX	50.084.XXX	50.086.XXX	50.089.XXX	50.092.XXX	
	220	Plain		-	-	50.040.XXX	50.042.XXX	50.045.XXX	50.048.XXX	
		Slotted		-	-	50.085.XXX	50.087.XXX	50.090.XXX	50.096.XXX	
280	Plain		-	-	-	50.043.XXX	50.046.XXX	50.049.XXX		
	Slotted		-	-	-	50.088.XXX	50.091.XXX	50.097.XXX		
1000	80	Plain		50.050.XXX	50.051.XXX	50.053.XXX	-	-	-	
		Slotted		50.098.XXX	50.164.XXX	50.166.XXX	-	-	-	
	160	Plain		55.739.XXX	50.052.XXX	50.054.XXX	50.056.XXX	50.059.XXX	50.062.XXX	
		Slotted		55.741.XXX	50.165.XXX	50.167.XXX	50.169.XXX	50.172.XXX	50.175.XXX	
	220	Plain		-	-	50.055.XXX	50.057.XXX	50.060.XXX	50.063.XXX	
		Slotted		-	-	50.168.XXX	50.170.XXX	50.173.XXX	50.176.XXX	
	280	Plain		-	-	-	50.058.XXX	50.061.XXX	50.064.XXX	
		Slotted		-	-	-	50.171.XXX	50.174.XXX	50.177.XXX	
	350	Plain		-	-	-	45.550.XXX	45.551.XXX	45.552.XXX	
		Slotted		-	-	-	45.556.XXX	45.557.XXX	45.558.XXX	
	1300	80	Plain		50.065.XXX	50.066.XXX	50.068.XXX	-	-	-
			Slotted		50.178.XXX	50.179.XXX	50.181.XXX	-	-	-
160		Plain		55.746.XXX	50.067.XXX	50.069.XXX	50.071.XXX	50.074.XXX	50.077.XXX	
		Slotted		55.747.XXX	50.180.XXX	50.182.XXX	50.184.XXX	50.187.XXX	50.190.XXX	
220		Plain		-	-	50.070.XXX	50.072.XXX	50.075.XXX	50.078.XXX	
		Slotted		-	-	50.183.XXX	50.185.XXX	50.188.XXX	50.191.XXX	
280		Plain		-	-	-	50.073.XXX	50.076.XXX	50.079.XXX	
		Slotted		-	-	-	50.186.XXX	50.189.XXX	50.192.XXX	





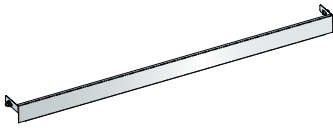

### Stop bars for sloping shelves

The stop bars can be screwed front and back to the shelf supports or side panels. The shelves and stop bars can also be slotted in at an angle. Ideal for making material and parts available according to the FIFO principle. Specification: Steel sheet. Colour: As per colour chart or galvanised.

W →	850	1000	1300
Art. no.	Art. no.	Art. no.	Art. no.
	50.316.XXX	50.317.XXX	50.318.XXX

#### Max. angle of inclination of the shelves:

Depth 300 = 33°, 350 = 29°, 400 = 28°, 500 = 25°, 600 = 23°, 800 = 20°



### Shelf labelling

Self-adhesive plastic label strips with hinged transparent protector, including labels. Width × height, 210 × 22 mm.

Sales units	Art. no.
10 pieces	18.931.000

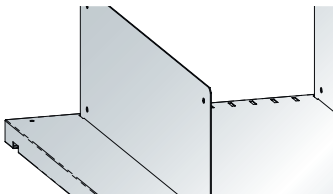

### Dividers

For subdividing slotted shelves. Specification: Steel sheet. Colour: As per colour chart or galvanised. Sales unit: 10 pcs.

D ↗	300	350	400	500	600	800
H ↑	Art. no.	Art. no.	Art. no.	Art. no.	Art. no.	Art. no.
100	50.103.XXX	50.106.XXX	50.109.XXX	50.112.XXX	50.115.XXX	50.118.XXX
150	50.104.XXX	50.107.XXX	50.110.XXX	50.113.XXX	50.116.XXX	50.119.XXX
200	50.105.XXX	50.108.XXX	50.111.XXX	50.114.XXX	50.117.XXX	50.120.XXX

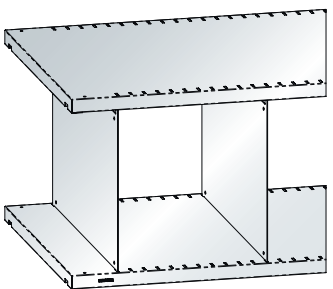

### Shelf dividers

For subdividing slotted shelves. The height of the shelf dividers, slotted in at the top and the bottom, depends on the distance between the shelves. Clear shelf spacing = shelf divider height. Specification: Steel sheet. Colour: As per colour chart or galvanised. Sales unit: 10 pcs.

D ↗	300	350	400	500	600	800
H ↑	Art. no.	Art. no.	Art. no.	Art. no.	Art. no.	Art. no.
250	50.121.XXX	50.126.XXX	50.131.XXX	50.136.XXX	50.141.XXX	50.146.XXX
300	50.122.XXX	50.127.XXX	50.132.XXX	50.137.XXX	50.142.XXX	50.147.XXX
325	50.123.XXX	50.128.XXX	50.133.XXX	50.138.XXX	50.143.XXX	50.148.XXX
350	50.124.XXX	50.129.XXX	50.134.XXX	50.139.XXX	50.144.XXX	50.149.XXX
400	50.125.XXX	50.130.XXX	50.135.XXX	50.140.XXX	50.145.XXX	50.150.XXX



# Shelving systems | Universal shelving L1006, single components

## 4. Shelf front cover strip

For storing bulk goods and small parts. Is screwed to the shelf supports or side panels. Including fastening material. Specification: Steel sheet. Colour: As per colour chart or galvanised.



	W →	850	1000	1300
H ↑		Art. no. 🌈	Art. no. 🌈	Art. no. 🌈
75		50.435.XXX	50.436.XXX	50.437.XXX



## Drawers

Smooth-running drawers with full extension for ideal storage of small parts and tools. Load capacity 50 kg. Specification: Steel sheet. Colour: As per colour chart, **not available in galvanised version**.

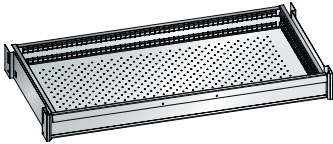

	W →	D ↗	1000 × 350	1000 × 500
H ↑			Art. no. 🌈	Art. no. 🌈
75			55.165.XXX	55.172.XXX
100			55.166.XXX	55.173.XXX
150			55.167.XXX	55.174.XXX
LISTA units			54 × 18 E	54 × 27 E
Useable drawer size (W × D mm)			918 × 306	918 × 459



## Drip trays

Can be placed loose on the shelves with a shelf width of 1,000 mm. Can also be removed if hinged doors are used. Specification: Height 100 mm, chromium steel. Material thickness: 2 mm. Welded liquid-tight. Designed according to Section 19 WHG (German Water Resources Act) / StawaR (German directive on steel trays). The drip tray is leak-tested and has a data plate to that effect as well as a test certificate.



		300	350	400	500	600	800
W →		Art. no.	Art. no.	Art. no.	Art. no.	Art. no.	Art. no.
1000		53.823.000	53.828.000	53.824.000	53.825.000	53.826.000	53.827.000
Capacity in litres		26	32	36	45	54	72

## Pull-out shelf

Load capacity 50 kg. Model: sheet steel. Colour: as per colour chart, **not available in galvanised version**.

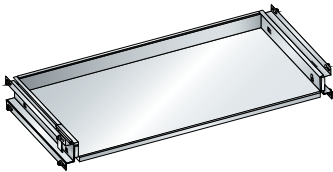

	W →	850	1000	1300
		757	907	1207
D ↗		Art. no. 🌈	Art. no. 🌈	Art. no. 🌈
350	332	46.370.XXX	46.371.XXX	46.372.XXX
400	382	46.373.XXX	46.374.XXX	46.375.XXX
500	482	46.376.XXX	46.377.XXX	46.378.XXX



## Pull-out suspension filing frame

Suitable for A4 suspension files. Max. load capacity 50 kg. Specification: Steel sheet. Colour: As per colour chart, **not available in galvanised version**.

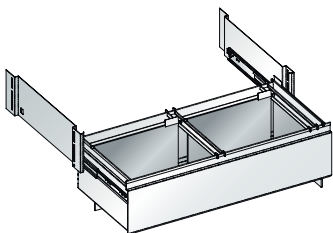

	W →	850	1000	1300
D ↗		Art. no. 🌈	Art. no. 🌈	Art. no. 🌈
350		50.441.XXX	50.444.XXX	50.446.XXX
400		50.442.XXX	50.445.XXX	50.447.XXX
500		50.443.XXX	50.156.XXX	50.448.XXX



## Lateral profiles

**C700.16** for storage system: Vetro lateral file A4 landscape (985 × 450 A4 lateral and folio)

**C700.17** for storage system: Datox EDP files, Monopendex files, ELBA centre point suspension files 91460, Leitz suspension files, Eichner suspension files. Specification: Steel sheet. Colour: Grey, NCS S 2502-R. Including fastening material.

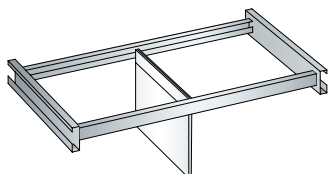

		W →	850	1000	1300
D ↗	version		Art. no.	Art. no.	Art. no.
350	C700.16		35.143.000	32.559.000	50.154.000
	C700.17		35.149.000	32.581.000	50.157.000
500	C700.16		35.147.000	32.578.000	50.155.000
	C700.17		35.153.000	32.599.000	50.158.000

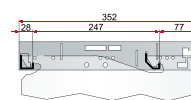

C700.16

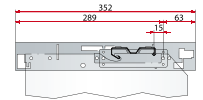

C700.17





### Centre partition

For vertically subdividing complete shelf units with a depth of 500 mm. The centre divider is fixed in place by the shelves. Width 30 mm. Height of centre divider = shelf unit height - 25 mm. Specification: Steel sheet. Colour: As per colour chart or galvanised.

	H ↑	2000	2200	2500
D ↗		Art. no.	Art. no.	Art. no.
500		50.328.XXX	50.329.XXX	50.330.XXX

**!** Select the top shelf so that it fits over the entire width of the shelving unit. Further assembly of the shelving units takes place with shelves for the centre partition.

### Plain shelves, smooth, for centre divider

Including floor anchor. Shelf thickness 25 mm. Unit load 80 kg. Specification: Steel sheet. Colour: As per colour chart or galvanised.

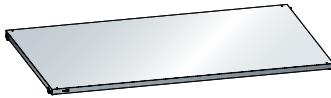

	W →	425	500	650
D ↗		Art. no.	Art. no.	Art. no.
500		50.325.XXX	50.326.XXX	50.327.XXX

### Clothes rail for centre divider

The clothes rails are fitted by means of crossbar plates and shelf supports. Specification: Rail made of anodised aluminium, Ø 27 mm, crossbars in sheet steel. Load capacity 50 kg. Colour of the crossbars: As per colour chart or galvanised.

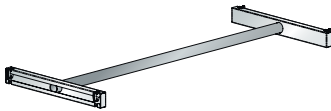

	W →	425	500	650
D ↗		Art. no.	Art. no.	Art. no.
500		50.495.XXX	50.496.XXX	50.497.XXX

### Clothes rail

The clothes rails are fitted by means of crossbar plates and shelf supports. Specification: Rail made of anodised aluminium, Ø 27 mm, crossbars in sheet steel. Load capacity 50 kg. Colour of the crossbars: As per colour chart or galvanised.

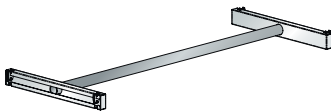

	W →	850	1000	1300
D ↗		Art. no.	Art. no.	Art. no.
400		50.498.XXX	50.502.XXX	50.506.XXX
500		50.499.XXX	50.503.XXX	50.507.XXX
600		50.500.XXX	50.504.XXX	50.508.XXX
800		50.501.XXX	50.505.XXX	50.509.XXX

### Organising rail

For vertical storage, compartment division and for storing various materials in rings (cables, vee belts and tubing). The crossbars are screwed to the shelf supports or side panels. Load capacity 50 kg. The brackets are screwed to the crossbar. Including fastening material. Specification: Steel sheet. Colour: As per colour chart, **not available in galvanised version**.

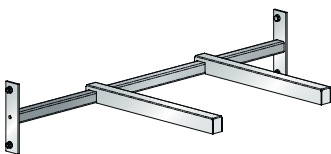

### Crossbars

	W →	850	1000	1300
		Art. no.	Art. no.	Art. no.
		50.486.XXX	50.487.XXX	50.488.XXX

### Brackets

	D ↗	300	350	400	500	600	800
		Art. no.	Art. no.	Art. no.	Art. no.	Art. no.	Art. no.
		50.489.XXX	50.490.XXX	50.491.XXX	50.492.XXX	50.493.XXX	50.494.XXX

### Pair of tyre shelf levels

Screwed together with the shelf supports. Model: sheet steel, galvanised.



W →	Shelf load kg	Model	Cod. art
1000	160	per pair	46.028.222
1300	160	per pair	46.029.222



## 5. Hinged doors

Hinged with a 2-point bar lock with a recess for a clasp lock (must be ordered separately). The hinged doors can also be retrofitted to all shelf units. Specification: Steel sheet. Colour: As per colour chart, **not available in galvanised version**.  
**Shelving depth with hinged door = shelving depth side panel/pair of shelf supports +30 mm**



H ↑ W →	Shelf supports			Side panel		
	850	1000	1300	850	1000	1300
1100	Art. no.  46.412.XXX	Art. no.  46.413.XXX	Art. no.  46.414.XXX	Art. no.  45.631.XXX	Art. no.  45.632.XXX	Art. no.  46.421.XXX
1450	46.415.XXX	46.416.XXX	46.417.XXX	45.633.XXX	45.634.XXX	46.422.XXX
1800	46.418.XXX	46.419.XXX	46.420.XXX	45.635.XXX	45.636.XXX	46.423.XXX
2000	50.472.XXX	50.473.XXX	50.474.XXX	50.467.XXX	50.160.XXX	50.162.XXX
2200	50.475.XXX	50.476.XXX	50.477.XXX	50.468.XXX	50.469.XXX	50.470.XXX
2500	50.478.XXX	50.479.XXX	50.480.XXX	50.471.XXX	50.161.XXX	50.163.XXX



### Cover profile with supports

Basic unit: 2 x cover profile and for each add-on unit 1 x cover profile. Specification: sheet steel. Colour: As per colour chart, **not available in galvanised version**.

**!** Cover profile for hinged doors is absolutely essential for all hinged doors used in combination with shelf supports.

H ↑	1100	1450	1800	2000	2200	2500
Art. no.	46.424.XXX	46.425.XXX	46.426.XXX	45.740.XXX	45.741.XXX	45.742.XXX

### + Clasp lock

KEY Lock, separately lockable	49.060.000
CODE Lock	49.085.000
RFID Lock	49.086.000



### + Clasp lock cover (optional)

Rear clasp lock cover for a more attractive appearance. **45.868.XXX**  
 Specification: sheet steel. Colour: As per colour chart.

## Sliding doors

Two shelving sections are closed with each sliding door. Running smoothly and quietly on castors: In a runner and guide rail which are fastened to the shelf supports at the bottom and/or at the top. Lockable with a lock-down cylinder lock. **The lock must be ordered separately**. The doors can be opened wide enough for one entire shelving unit to be freely accessible. The sliding doors can also be fitted later. Specification: Steel sheet. Colour: As per colour chart, **not available in galvanised version**. **Shelving depth with hinged door = shelving depth side panel/pair of shelf supports +105 mm**



H ↑ W →	Shelf supports			Side panel		
	2 x 850	2 x 1000	2 x 1300	2 x 850	2 x 1000	2 x 1300
2000	Art. no.  50.458.XXX	Art. no.  50.459.XXX	Art. no.  50.460.XXX	Art. no.  50.449.XXX	Art. no.  50.450.XXX	Art. no.  50.451.XXX
2200	50.461.XXX	50.462.XXX	50.463.XXX	50.452.XXX	50.453.XXX	50.454.XXX
2500	50.464.XXX	50.465.XXX	50.466.XXX	50.455.XXX	50.456.XXX	50.457.XXX

### + Lock-down cylinder lock

KEY Lock, separately lockable	55.438.000
-------------------------------	------------



## 6. Add-on elements for "Office"

### Sideboard

Equipment: with optional multiplex or resin cover panel. Side panels, side panel covers (right and left) for covering the rows of slots and for flush closure with the front triangular edging, rear panel cover for shelving units and lengthwise stability. 3–4 shelves, slotted (thickness 25 mm) per shelf bay Description: sheet steel. Colour: according to colour chart or galvanised.



D	Actual depth mm	H	Number shelves	Actual height mm	Actual width mm	1000	2 x 1000
						1047	2047
350	395	1100	3	1132	Multiplex	Art. no.  45.975.XXX	Art. no.  45.976.XXX
				1124	Resin	45.977.XXX	45.978.XXX
		1450	4	1482	Multiplex	45.979.XXX	45.980.XXX
				1474	Resin	45.981.XXX	45.982.XXX
400	445	1100	3	1132	Multiplex	45.983.XXX	45.984.XXX
				1124	Resin	45.985.XXX	45.986.XXX
		1450	4	1482	Multiplex	45.987.XXX	45.988.XXX
				1474	Resin	45.989.XXX	45.990.XXX
Shelf load (kg)						80	80



### Cover panel, resin-coated, thickness 22 mm

Surface and edging light grey, NCS S 1500-N, laminated chipboard (quality class E1), with melamine coating on both sides (manufactured according to standard EN 14322). 2 mm thick plastic edging on all sides. Including double-sided adhesive tape.



### Multiplex cover panel, thickness 30 mm

Made of steamed beech veneers, glued in multiple layers and waterproof (DIN 68 705), bevelled edges, sanded, oiled and waxed surface. The panel is splash-proof, dirt-repellent and largely impervious to oil and grease. Including double-sided adhesive tape.



## Shelving systems | Heavy-duty pull-out shelving systems

**Heavy-duty pull-out shelving systems are ideal for the safe and convenient storage of heavy items such as injection moulds, punching tools, electric motors and pallet goods.** Since they can be loaded using lifting gear, they can be installed in a compact arrangement. Load capacities of up to 9000 kg per unit and the availability of different shelving heights, shelf depths and unit widths and the wide selection of equipment options mean that they can be adapted to perfectly suit any type of storage item.





**+ Utmost stability**  
through robust, solid design with a very high load capacity of up to 9 t per shelving unit

**+ Optimum use of space**  
with shelving heights of up to 2.50 m for perfectly organised storage of very heavy inventory items

**+ High load capacities**  
up to 200 kg per top shelf, up to 1000 kg per fixed and pull-out frame

**+ Secure locking**  
with smooth-running roller shutters in combination with side and rear panels

**+ Can be adapted to new storage items at any time** – through the flexible integration and rearrangement of fixed and pull-out frames in increments of 100 mm

**+ Extremely smooth running**  
through smooth-running pull-outs with stops in closed and fully extendable positions

**+ Optimum order and organisation**  
pallets can be stored lengthwise or crosswise in fixed and pull-out frames

**+ Safe and orderly storage**  
flush storage achieved by placing sheet metal covers on top or inserting chipboard inserts

## Dimensions and load capacities

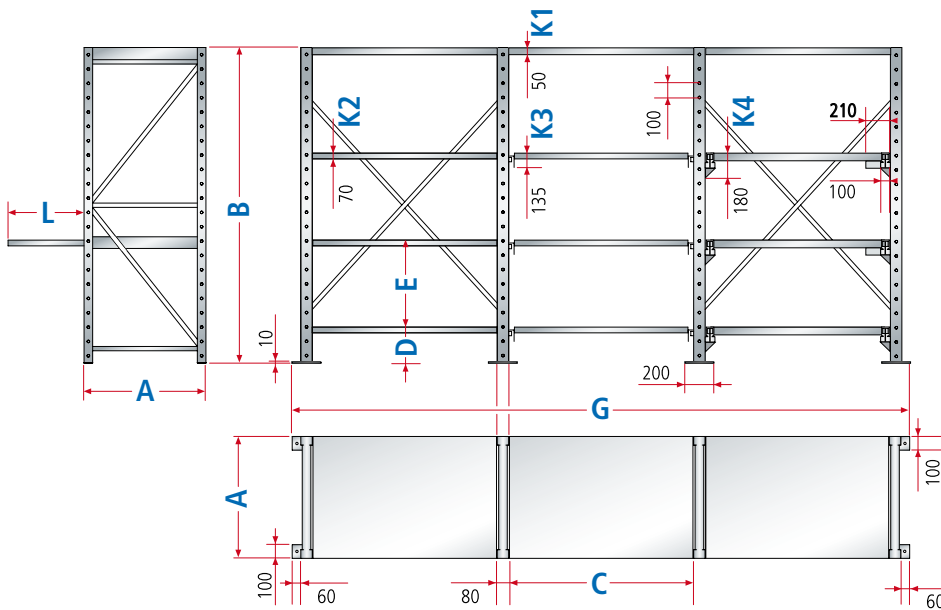

**A** = Shelving depth  
**B** = Shelving height  
**C** = Shelving width

**D** = Minimum distance from floor  
**E** = Minimum distance top edge to top edge

**G** = Number of installation widths + number of side frame widths 80 mm + external base plate widths 60 mm  
 Example:  $G = 3 \times 1090 \text{ mm} + 4 \times 80 \text{ mm} + 2 \times 60 \text{ mm} = 3710 \text{ mm}$   
**K1...K4** = Installation heights

### Lengthwise pallet storage

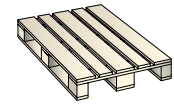

Pallet type	Width mm	Depth mm	Height mm
I	800	1200	150

### Crosswise pallet storage

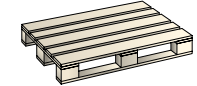

Pallet type	Width mm	Depth mm	Height mm
I	800	1200	150
II	1200	800	150
III	1200	1000	150
IIII	1000	800	150

### Shelving depths (A)

<b>D</b> Installed dimensions mm	860	1060	1260
<b>Extension depths (L) mm</b>			
Part extension, 65% extension	510	650	810
Full extension, ~ 100% extension	790	990	1190

### Shelf widths (C)

<b>W</b> Installed dimensions mm	890	1090	1290
Side frame width	80	80	80
Base plate width	200	200	200

### Load capacities

<b>D</b> Installed dimensions mm	860	1060	1260
Number of pull-out frames			
Fixed frame Number			
		Max. load capacity per pull-out or fixed frame $\text{kg}$	
1 to 5	-	1000	900
1 to 6	-	900	900
1 to 7	-	800	800
1 to 8	-	700	700
1 to 9	-	600	600
-	1 to 9	1000	900
1 to 3	1 to 6	1000	900
1 to 5	1 to 4	800	800
Max. load capacity per top shelf $\text{kg}$		200	150

The maximum load capacities specified must not be exceeded. The load capacities apply only to an evenly distributed load. The maximum load capacity per shelving unit is 9000 kg. **Only one pull-out frame per shelving unit may be pulled out.**

### Shelving heights (B)

<b>H</b> Nominal dimensions mm	1500	2000	2200	2500
--------------------------------	------	------	------	------

### Installation heights (K)

Top shelf	<b>K1</b>	50 mm
Fixed frame	<b>K2</b>	70 mm
Part extension frame	<b>K3</b>	135 mm
Full extension frame	<b>K4</b>	180 mm

### Vertical installation distances

Distance from floor (D) minimum	105 mm for fixed frame
	165 mm for part extension frame
	215 mm for full extension frame
Minimum distance (E) top edge to top edge	100 mm for fixed frame
	200 mm for full extension and part extension frame
	300 mm for full extension frame with sheet metal cover
Hole spacing	every 100 mm

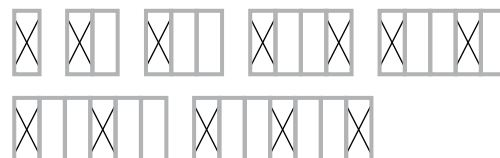

### Diagonal brace arrangement

the load capacities only apply when, for 6 shelf units or more, 2 shelf units or at least every fifth shelf unit is fitted with rear panels or 1 diagonal brace per 3 units.

### ! Anchoring rule

Heavy-duty pull-out shelving units must always be anchored.



**+** Optimum use of space for very heavy storage items



**Pallet storage**

- space-saving pallet storage with a load capacity of up to 1000 kg in fixed frames

**Heavy-duty pull-out shelving systems 9000, disassembled**

With 2 pull-out frames for part extension (PE, 65% extension) and 1 fixed frame as top shelf, each including chipboard inserts, 40 mm thick. Can be fitted with side panels, further pull-out and fixed frames, metal covers, sliding doors, roller shutters and column guard. Basic unit including 1 diagonal brace for lengthwise stability, 2 side frames, floor anchor and levelling plate set. Add-on unit including 1 side frame, floor anchor and levelling plate set. Hole spacing in the side frame every 100 mm. Specification: steel sheet. Colour: as per colour chart.

**Note:** from the third add-on unit, an **additional diagonal brace** is required (see p. 242).

**H** **2000 mm**

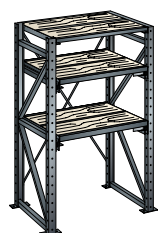

		Pull-out frames	Fixed frames	Shelf load kg	Max. load per unit kg	Basic unit Art. no.	Add-on unit Art. no.
860	890	2	1	1000	9000	71.530.XXX	71.534.XXX
860	1290	2	1	1000	9000	71.532.XXX	71.536.XXX

1260	890	2	1	800	9000	71.531.XXX	71.535.XXX
1260	1290	2	1	800	9000	71.533.XXX	71.537.XXX



**Heavy-duty pull-out shelves up to 1000 kg**

- for storing large, heavy single items and equipment
- flush storage achieved by placing sheet metal covers on top or inserting chipboard inserts





## ! Side frames

Side frames are perforated at intervals of 100 mm to allow installation of top shelves, fixed and pull-out frames. Front and back columns are welded together with horizontal and diagonal braces to form a rigid frame. Specification: sheet steel pressed profiles. Colour: as per colour chart.

**Caution:** four floor anchors are required per side frame.

## Side frame cover

For covering the top of the side frames. Specification: sheet steel. Colour: according to colour chart.



## Side panels

The side panels and the side frame columns are screwed together. The standard side panels are used for the roller shutter structure. Includes screw fixtures. Specification: sheet steel 1.5 mm. Colour: according to colour chart.



## ! Side frame connections

Screwed to the side frames at the front and rear. Including screw fasteners. Specification: flat steel. Colour: as per colour chart.



## ! Diagonal braces

Used instead of rear panels to stabilise units lengthwise. Including screw fasteners. Specification: Steel, galvanised. Number of diagonal braces: see planning notes p. 240.

or...

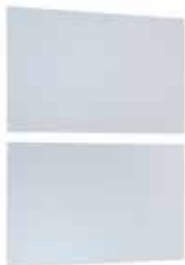

## ! Rear panels

The rear panel cover for shelving sections also stabilises the units lengthwise and is screwed to the side frames with the columns. Including fastening material. Specification: steel sheet. Colour: as per colour chart.

Installed dimensions mm



860

1060

1260

### Side frames



1500

2000

2200

2500



80

80

80

80

Art. no.

73.000.XXX

73.001.XXX

73.002.XXX

73.003.XXX

Art. no.

73.010.XXX

73.011.XXX

73.012.XXX

73.013.XXX

Art. no.

73.020.XXX

73.021.XXX

73.022.XXX

73.023.XXX

for shelving depth mm



860

1060

1260

### Side frame cover

Art. no.

73.590.XXX

Art. no.

73.591.XXX

Art. no.

73.592.XXX

for shelving depth mm



860

1060

1260

### Side panels



1500

2000

2200

2500

Art. no.

73.500.XXX

73.501.XXX

73.502.XXX

73.503.XXX

Art. no.

73.510.XXX

73.511.XXX

73.512.XXX

73.513.XXX

Art. no.

73.520.XXX

73.521.XXX

73.522.XXX

73.523.XXX

Installed dimensions mm



890

1090

1290

### Side frame connections

Per pair

Art. no.

73.060.XXX

Art. no.

73.061.XXX

Art. no.

73.062.XXX

### Diagonal braces



1500

2000

2200

2500

Art. no.

73.100.000

73.101.000

73.102.000

73.103.000

Art. no.

73.110.000

73.111.000

73.112.000

73.113.000

Art. no.

73.120.000

73.121.000

73.122.000

73.123.000

### Rear panels



1500

2000

2200

2500

Art. no.

73.530.XXX

73.531.XXX

73.532.XXX

73.533.XXX

Art. no.

73.540.XXX

73.541.XXX

73.542.XXX

73.543.XXX

Art. no.

73.550.XXX

73.551.XXX

73.552.XXX

73.553.XXX

Number of parts/dimensions mm

1 × 1000, 1 × 500

1 × 1000, 1 × 500

1 × 1000, 1 × 500

Number of parts/dimensions mm

2 × 1000

2 × 1000

2 × 1000

Number of parts/dimensions mm

1 × 1000, 2 × 600

1 × 1000, 2 × 600

1 × 1000, 2 × 600

Number of parts/dimensions mm

2 × 1000, 1 × 500

2 × 1000, 1 × 500

2 × 1000, 1 × 500

Actual width mm

1000

1200

1400





### Levelling plates

To compensate for height. Enable units to be aligned with precision on uneven floors. Specification: PVC. Colour: grey.

### Levelling plates

Thickness 1 mm	73.005.000
Thickness 2 mm	73.006.000
Thickness 4 mm	73.007.000
Dimensions (W × D mm)	100 × 200



### ! Floor anchoring

Heavy-duty pull-out shelving units must always be anchored.

### Floor anchor

M10 × 130, each	112.991.000
-----------------	-------------



### Column guard PC6

Safety feature to protect exposed side frames. With 4 holes for floor anchoring. Including 4 segment anchors M12 × 140 mm (drill hole depth 140 mm). Specification: sheet steel, St 37-2. Colour: yellow/black.

### Column guard PC6

W 166 × D 166 × H 322	43.537.000
-----------------------	------------

**! In order to comply with regulations, and for safety reasons, heavy-duty pull-out units must consist of at least these elements**



# Shelving systems | Heavy-duty pull-out shelving systems fixed and pull-out frames



## ! Fixed frame

Instead of the top shelves, fixed frames can also be used. The fixed frames are screwed to the side frames. Including screw fasteners. Specification: Pressed profile, welded. Colour: as per colour chart.



## Metal sheet covers for fixed frames

Placed on loosely. Locked in place with a bent section at the front and rear and a stop bracket welded on at the rear. Specification: steel sheet, 2 mm thick. Colour: as per colour chart.



## Chipboard inserts for fixed frames

2-piece, to be inserted into the fixed frames. Specification: chipboard, 40 mm thick.

or...



## Pull-out frames for part extension

Part extension (PE), 65% extension. The pull-out stop secures the pull-out frame in both closed and open positions. The runners are screwed to the side frames. Including screw fasteners. Specification: Pressed profile, welded. Colour: as per colour chart.



## Metal sheet covers for pull-out frames (part extension)

With raised edge on 3 sides, 30 mm high, placed on loosely. Locked in place with a bent section at the front and a stop bracket welded on at the rear. Specification: steel sheet, 2 mm thick. Colour: as per colour chart.



## Chipboard inserts for pull-out frames (part extension)

2-piece, to be inserted into the pull-out frames for part extension. Specification: chipboard, 40 mm thick.

Installed dimensions mm	<b>D</b>	<b>860</b>	<b>1060</b>	<b>1260</b>
Usable depth mm		840	1040	1240
<b>Fixed frame</b>				
<b>W</b>	Usable width mm	Art. no.	Art. no.	Art. no.
<b>890</b>	860	<b>73.030.XXX</b>	<b>73.031.XXX</b>	<b>73.032.XXX</b>
<b>1090</b>	1060	<b>73.040.XXX</b>	<b>73.041.XXX</b>	<b>73.042.XXX</b>
<b>1290</b>	1260	<b>73.050.XXX</b>	<b>73.051.XXX</b>	<b>73.052.XXX</b>
Load capacity (kg)		1000	900	800

## Metal sheet covers for fixed frames

<b>W</b>	Usable width mm	Art. no.	Art. no.	Art. no.
<b>890</b>	860	<b>73.130.XXX</b>	<b>73.131.XXX</b>	<b>73.132.XXX</b>
<b>1090</b>	1060	<b>73.140.XXX</b>	<b>73.141.XXX</b>	<b>73.142.XXX</b>
<b>1290</b>	1260	<b>73.150.XXX</b>	<b>73.151.XXX</b>	<b>73.152.XXX</b>

## Chipboard inserts for fixed frames

<b>W</b>	Usable/actual width mm	Art. no.	Art. no.	Art. no.
<b>890</b>	860 / 869	<b>73.430.000</b>	<b>73.431.000</b>	<b>73.432.000</b>
<b>1090</b>	1060 / 1069	<b>73.440.000</b>	<b>73.441.000</b>	<b>73.442.000</b>
<b>1290</b>	1260 / 1269	<b>73.450.000</b>	<b>73.451.000</b>	<b>73.452.000</b>
Actual depth mm (2-part)		345	445	545

Installed dimensions mm	<b>D</b>	<b>860</b>	<b>1060</b>	<b>1260</b>
Usable depth mm		810	1010	1210
<b>Pull-out frames for part extension</b>				
<b>W</b>	Usable width mm	Art. no.	Art. no.	Art. no.
<b>890</b>	800	<b>73.070.XXX</b>	<b>73.071.XXX</b>	<b>73.072.XXX</b>
<b>1090</b>	1000	<b>73.080.XXX</b>	<b>73.081.XXX</b>	<b>73.082.XXX</b>
<b>1290</b>	1200	<b>73.090.XXX</b>	<b>73.091.XXX</b>	<b>73.092.XXX</b>
Load capacity (kg)		1000	900	800

## Metal sheet covers for pull-out frames (part extension)

<b>W</b>	Usable width mm	Art. no.	Art. no.	Art. no.
<b>890</b>	800	<b>73.270.XXX</b>	<b>73.271.XXX</b>	<b>73.272.XXX</b>
<b>1090</b>	1000	<b>73.280.XXX</b>	<b>73.281.XXX</b>	<b>73.282.XXX</b>
<b>1290</b>	1200	<b>73.290.XXX</b>	<b>73.291.XXX</b>	<b>73.292.XXX</b>

## Chipboard inserts for pull-out frames (part extension)

<b>W</b>	Usable/actual width mm	Art. no.	Art. no.	Art. no.
<b>890</b>	800 / 772	<b>73.470.000</b>	<b>73.471.000</b>	<b>73.472.000</b>
<b>1090</b>	1000 / 972	<b>73.480.000</b>	<b>73.481.000</b>	<b>73.482.000</b>
<b>1290</b>	1200 / 1172	<b>73.490.000</b>	<b>73.491.000</b>	<b>73.492.000</b>
Actual depth mm (2-part)		330	430	530

**! In order to comply with regulations, and for safety reasons, heavy-duty pull-out shelving systems must consist of at least these elements.**

or...



### Pull-out frames for full extension

Full extension (FE), 100% extension. The pull-out stop secures the pull-out frame in both closed and open positions. The runners are screwed to the side frames. Including screw fasteners. Specification: Pressed profile, welded. Colour: as per colour chart.



### Metal sheet covers for pull-out frames (full extension)

With raised edge on 3 sides, 30 mm high, placed on loosely. Locked in place with a bent section at the front and a stop bracket welded on at the rear. Specification: steel sheet, 2 mm thick. Colour: as per colour chart.



### Chipboard inserts for pull-out frames (full extension)

2-piece, to be inserted into the pull-out frames for full extension. Specification: chipboard, 40 mm thick.



### ! Top Shelves

Cover the top of the side frames and provide protection from dust. Fitting material included. Specification: sheet steel. Colour: according to colour chart.

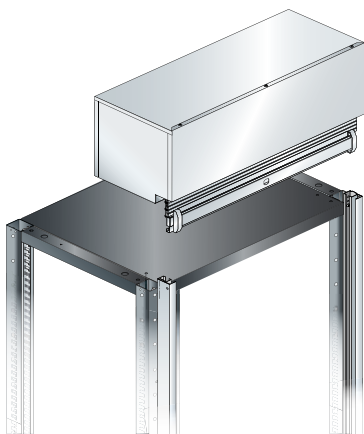

### Roller shutter including top shelf

Pre-assembled roller shutter housing. Roller shutter guided in vertical profiles on side frame. With recess for lever tumbler lock. For initial assembly, including top shelf, pre-drilled, for attaching the roller shutter housing. Description: roller shutter housing and guide profiles made of sheet steel. Colours: according to colour chart. Roller shutter with plastic slats. Colour: pale grey, RAL 7035. Note: the height of the shelving is increased by 323 mm due to the design.

Installed dimensions mm		860	1060	1260
Usable depth mm		810	1010	1210

#### Pull-out frames for full extension

	Usable width mm	Art. no.	Art. no.	Art. no.
890	800	73.210.XXX	73.211.XXX	45.008.XXX
1090	1000	73.212.XXX	73.213.XXX	73.214.XXX
1290	1200	45.009.XXX	73.215.XXX	73.216.XXX
Load capacity (kg)		1000	900	800

#### Metal sheet covers for pull-out frames (full extension)

	Usable width mm	Art. no.	Art. no.	Art. no.
890	800	73.217.XXX	73.218.XXX	45.250.XXX
1090	1000	73.219.XXX	73.220.XXX	73.221.XXX
1290	1200	45.251.XXX	73.222.XXX	73.223.XXX

#### Chipboard inserts for pull-out frames (full extension)

	Usable/actual width mm	Art. no.	Art. no.	Art. no.
890	800 / 680	73.224.000	73.225.000	45.252.000
1090	1000 / 880	73.226.000	73.227.000	73.228.000
1290	1200 / 1080	45.253.000	73.229.000	73.230.000
Actual depth mm (2-part)		330	430	530

Installed dimensions mm		860	1060	1260
Usable depth mm		840	1040	1240

#### Top Shelves

	Usable width mm	Art. no.	Art. no.	Art. no.
890	890	73.650.XXX	73.651.XXX	73.652.XXX
1090	1090	73.660.XXX	73.661.XXX	73.662.XXX
1290	1290	73.670.XXX	73.671.XXX	73.672.XXX
Load capacity (kg)		200	150	100

Installed dimensions mm		860	1060	1260
-------------------------	--	-----	------	------

#### Roller shutter including top shelf

		Art. no.	Art. no.	Art. no.
2000	890	73.231.XXX	73.232.XXX	73.233.XXX
	1090	73.240.XXX	73.241.XXX	73.242.XXX
	1290	73.249.XXX	73.250.XXX	73.251.XXX
2200	890	73.234.XXX	73.235.XXX	73.236.XXX
	1090	73.243.XXX	73.244.XXX	73.245.XXX
	1290	73.252.XXX	73.253.XXX	73.254.XXX
2500	890	73.237.XXX	73.238.XXX	73.239.XXX
	1090	73.246.XXX	73.247.XXX	73.248.XXX
	1290	73.255.XXX	73.256.XXX	73.257.XXX

#### + lever tumbler lock

KEY Lock, Separately lockable	49.090.000
-------------------------------	------------



## Shelving systems | Mobile shelf units

**A LISTA mobile shelving system is the perfect way to create plenty of storage space in confined areas.** When more space is needed in existing premises, LISTA has the perfect solution: create more space without extending. Fixed shelf units are needed only if simultaneous access to all stored items is necessary; otherwise, aisles between shelf units are simply uneconomical. Instead of many space-consuming service aisles between the fixed shelf units, only one single aisle is needed to provide access to all shelving.



### **A wide variety of equipment options**

with different drives and rail systems



### **Protects against dirt**

through horizontal and vertical dust seals



### **Secure locking option**

central locking system and linking hook provide protection against unauthorised access



### **Outstanding safety features**

aisle can be locked during service times; movement of the system is not possible

## + Benefits of LISTA mobile shelf units

### Conventional storage

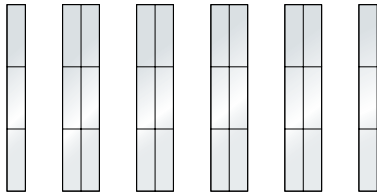
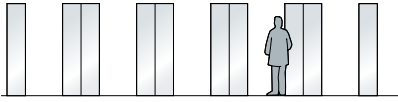

30 shelving units each providing 6 shelf metres = **180 shelf metres.**

### Storage with mobile shelf units

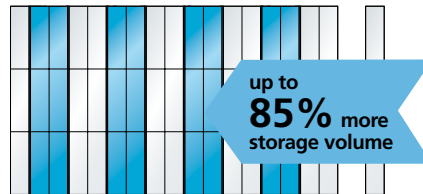
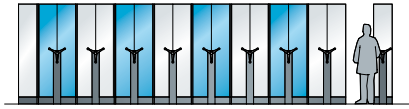

54 shelving units each providing 6 shelf metres = **324 shelf metres.**

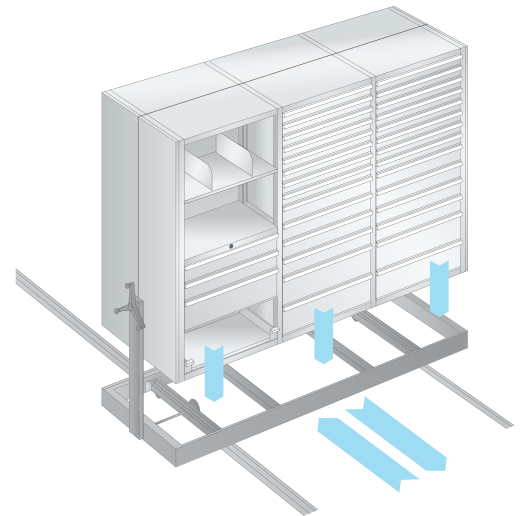

## + Flexible range of applications

LISTA offers suitable storage solutions for all types of stored goods. Universal and drawer storage walls are perfectly suited for use with mobile substructures. LISTA planning specialists utilise the many options offered by the mobile shelf unit system. Every organisation detail is managed according to your requirements – from the design to the turnkey installation of your system.



### Universal shelving L1006 R Design "Solid sheet side panel"

Diagonal braces or rear panels ensure stability. Depending on the dimensions and specification, shelves have a load capacity between 80 and 280 kg. The maximum load-bearing capacity of a shelving unit is about 500 kg.

For more information on universal shelving systems see page 220.



### Universal shelving L1006 Design "shelf supports"

Suitable for bulky or heavy stored goods. They provide optimum air circulation thanks to their open design. Stability is ensured by diagonal braces or rear panels. Depending on their dimensions, the shelves have a load capacity between 80 and 280 kg. Maximum load capacity per shelving unit up to 1000 kg.

For more information on universal shelving systems see page 220.



### Drawer storage walls

The drawer options for small parts or tools are virtually unlimited. The many drawer sizes together with the large range of partition components provide a flexible and adaptable basis for optimum and material-friendly storage.

For more information on drawer storage walls, see page 84.

# SYSTEMATIC ORGANISATION

**LISTA drawer partition materials create systematic order for all industries and all requirements.** From small parts to NC tools, our plastic boxes, troughs, metal dividers and more provide flexible solutions for practically any kind of storage item. The results speak for themselves: because systematic organisation means less time searching for stored items, simplified workflows and efficient results.

### + **Wide range of specifications in a modular system**

with preconfigured sets and freely combinable individual elements such as slotted partitions, metal dividers, plastic boxes, troughs, etc.

### + **Fully combinable**

with the entire LISTA range thanks to the standardised unit of measure

### + **Fast and easy assembly**

the walls surrounding the interior of the drawers have a slotted grid and the bottoms of the drawers are perforated for the insertion and attachment of slotted partitions, metal dividers, milling cutter holders and holding pins

### + **Professional labelling**

with LISTA Script labelling software for labels, clip-on label holders and barcode holders



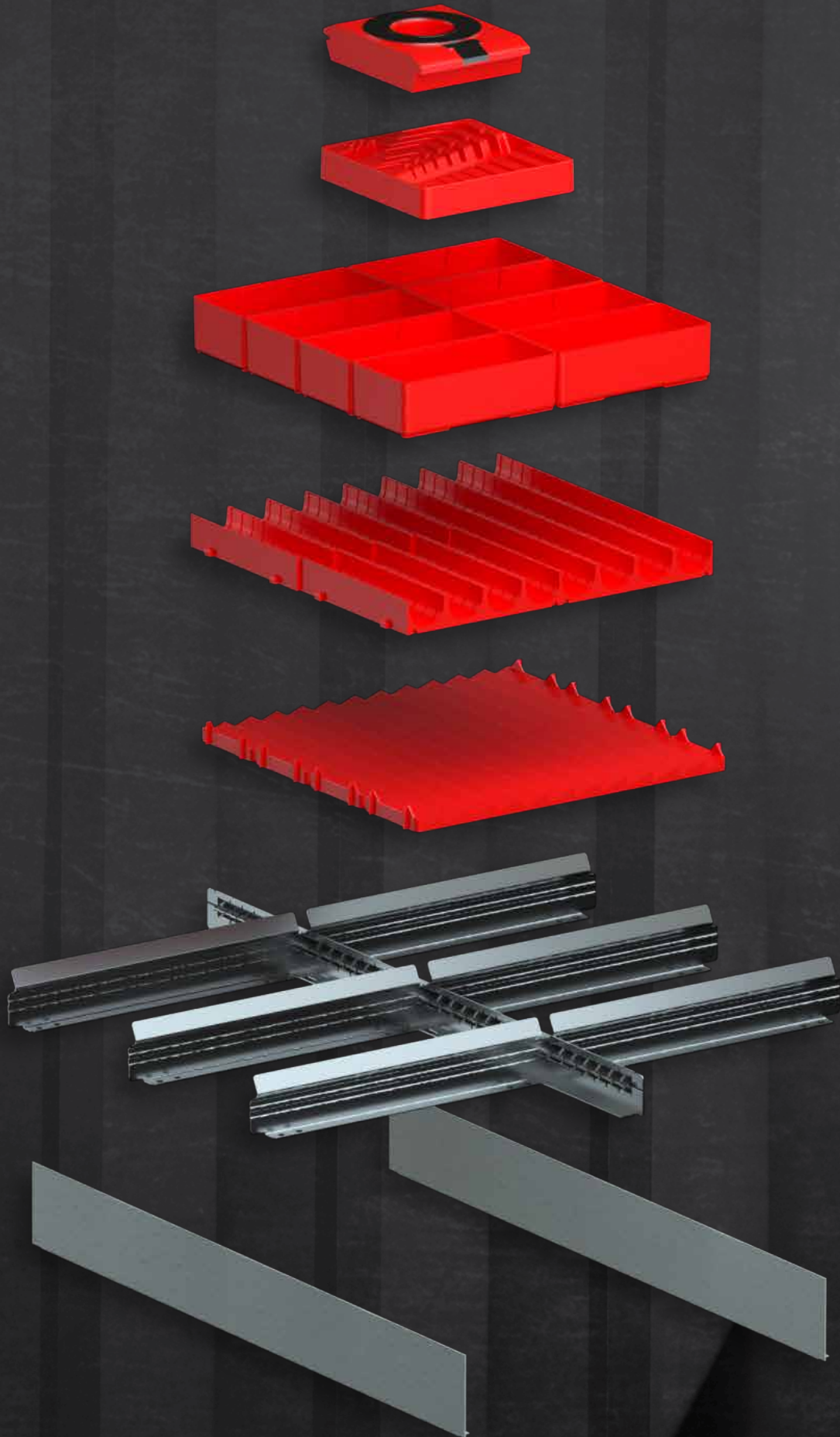

# Partition material

## + One system, many different options

Thanks to the LISTA Unit measuring system, our partition materials can be freely combined and are compatible with the entire LISTA range. This means that you have the ideal storage system for your particular storage items – either as individual parts or as a preconfigured set.

## + The LISTA Unit (E) – the clever measurement system

Using a practical grid system, the LISTA unit (E) ensures that housings, drawers and partition materials always fit neatly together. **A LISTA unit (E) is 17 mm** and is based on the grid system for partitioning drawers. Drawer cabinet housings and the drawers that fit into this housing are based on the same LISTA Units, even though they have different dimensions.

### Determining the right partition material:

1. Determine the drawer size in LISTA Units (E)
2. Determine the dimensions of the set or the individual parts in LISTA Units (E)
3. The sum in Units of the individual parts must not exceed the sum in Units of the drawer(s)  
Take the usable height of the drawer into account according to the goods to be stored.

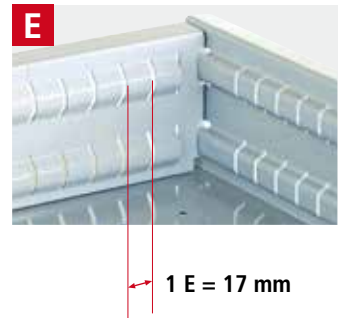

» For more information, see fold-out.



## + Wide range of specifications in a modular system



### Plastic boxes

- perfect for small parts of various sizes
- also available in ESD



### Troughs

- for cylindrical items
- can be divided lengthwise as desired
- also available in ESD



### Slotted partitions and metal dividers

- for flexible partitioning
- for parts of different sizes



### Holding pins and non-slip mats

- ideal for larger items

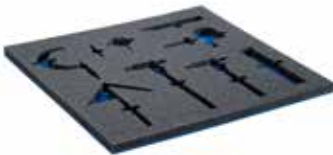

### Foam inserts with blue underlays

- protects tools and other items and keeps them organised
- hold items firmly in place in the drawer



### NC tool holders

- for neat and orderly storage of NC items

» For NC storage and transport systems see p. 100



### LISTA Script

- clip-on label holders for plastic boxes, troughs and metal dividers
- helps you keep an overview of your inventory and can easily be read by a barcode scanner

» LISTA Script see p. 268



You can find our LISTA Script labelling software on our [website](http://www.lista.com) under **Products › Accessories › LISTA Script**

The entire LISTA range can be found online at [www.lista.com](http://www.lista.com).



**18 × 27 E**

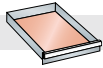

306 × 459 mm

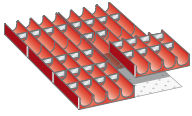

### Troughs

For front height mm	Art. no.
<b>50</b>	<b>80.377.000</b>
6 troughs:	4-piece, Ø 33 mm*
30 trough dividers:	4-piece, Ø 33 mm*

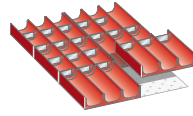

### Troughs

For front height mm	Art. no.
<b>50</b>	<b>80.378.000</b>
6 troughs:	3-piece, Ø 45 mm*
20 trough dividers:	3-piece, Ø 45 mm*

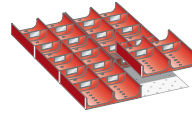

### Troughs

For front height mm	Art. no.
<b>50</b>	<b>80.379.000</b>
6 troughs:	2-piece, Ø 70 mm*
20 trough dividers:	2-piece, Ø 70 mm*

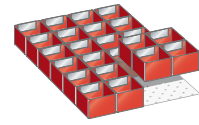

### Plastic boxes

For front height mm	Art. no.
<b>50</b>	<b>80.372.000</b>
<b>75</b>	<b>80.414.000</b>
24 plastic boxes:	75 × 75 mm

\* Take the usable height of the drawer into account according to the goods to be stored.

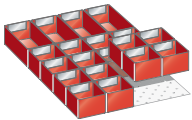

### Plastic boxes

For front height mm	Art. no.
<b>50</b>	<b>80.368.000</b>
<b>75</b>	<b>80.412.000</b>
16 plastic boxes:	75 × 75 mm
4 plastic boxes:	75 × 150 mm

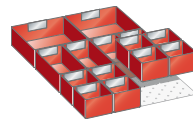

### Plastic boxes

For front height mm	Art. no.
<b>50</b>	<b>80.370.000</b>
<b>75</b>	<b>80.413.000</b>
8 plastic boxes:	75 × 75 mm
4 plastic boxes:	75 × 150 mm
2 plastic boxes:	150 × 150 mm

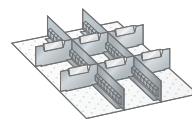

### Slotted partitions and metal dividers

For front height mm	Art. no.
<b>50</b>	<b>80.639.000</b>
<b>75</b>	<b>80.640.000</b>
<b>100</b>	<b>80.641.000</b>
<b>150</b>	<b>80.642.000</b>
2 slotted partitions:	27 E
6 metal dividers:	6 E

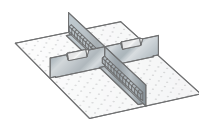

### Slotted partitions and metal dividers

For front height mm	Art. no.
<b>50</b>	<b>80.643.000</b>
<b>75</b>	<b>80.644.000</b>
<b>100</b>	<b>80.645.000</b>
<b>150</b>	<b>80.646.000</b>
<b>200</b>	<b>80.647.000</b>
<b>300</b>	<b>80.648.000</b>
1 slotted partition:	27 E
2 metal dividers:	9 E



**27 × 27 E**

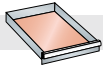

459 × 459 mm

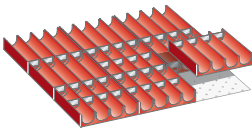

**Troughs**

For front height mm	Art. no.
50	80.656.000
9 troughs:	4-piece, Ø 33 mm*
40 trough dividers:	4-piece, Ø 33 mm*

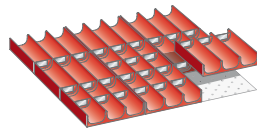

**Troughs**

For front height mm	Art. no.
50	80.657.000
9 troughs:	3-piece, Ø 45 mm*
30 trough dividers:	3-piece, Ø 45 mm*

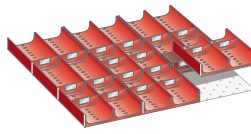

**Troughs**

For front height mm	Art. no.
50	80.658.000
9 troughs:	2-piece, Ø 70 mm*
20 trough dividers:	2-piece, Ø 70 mm*

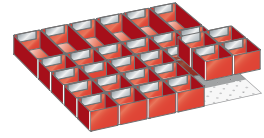

**Plastic boxes**

For front height mm	Art. no.
50	80.659.000
75	80.660.000
24 plastic boxes:	75 × 75 mm
6 plastic boxes:	150 × 75 mm

\* Take the usable height of the drawer into account according to the goods to be stored.

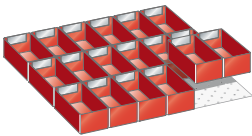

**Plastic boxes**

For front height mm	Art. no.
50	80.661.000
75	80.662.000
100, 125	80.663.000
18 plastic boxes:	150 × 75 mm

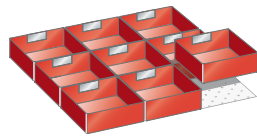

**Plastic boxes**

For front height mm	Art. no.
50	80.664.000
75	80.665.000
100, 125	80.666.000
9 plastic boxes:	150 × 150 mm

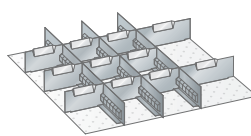

**Slotted partitions and metal dividers**

For front height mm	Art. no.
50	80.667.000
75	80.668.000
100, 125	80.669.000
150	80.670.000
3 slotted partitions:	27 E
9 metal dividers:	6 E
2 metal dividers:	9 E

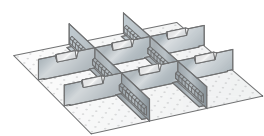

**Slotted partitions and metal dividers**

For front height mm	Art. no.
50	80.671.000
75	80.672.000
100, 125	80.673.000
150	80.674.000
200	80.675.000
250	80.676.000
300	80.677.000
2 slotted partitions:	27 E
6 metal dividers:	9 E

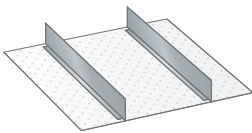

**Dividers**

For front height mm	Art. no.
75	100.315.000
100, 125	100.130.000
150	100.131.000
200	100.132.000
250	100.133.000
2 dividers:	27 E

**Note**

The front height is the same as the height of the drawer front. For the actual height of the partition material see p. 262–265.

Partition material sets excluding clip-on label holder.

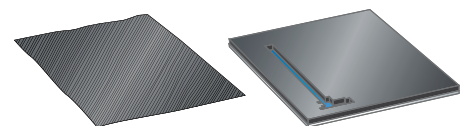

» Non-slip mats and PE foam inserts, see p. 267



**36 × 27 E**

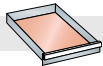

612 × 459 mm

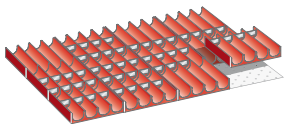

### Troughs

For front height  
mm

Art. no.

**50**      **100.283.000**

12 troughs:      4-piece, Ø 33 mm\*  
50 trough dividers: 4-piece, Ø 33 mm\*

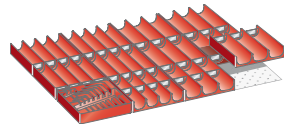

### Trough and Allen key insert

For front height  
mm

Art. no.

**50**      **100.312.000**

5 troughs:      4-piece, Ø 33 mm\*  
20 trough dividers: 4-piece, Ø 33 mm\*  
6 troughs:      3-piece, Ø 45 mm\*  
20 trough dividers: 3-piece, Ø 45 mm\*  
1 Allen key insert

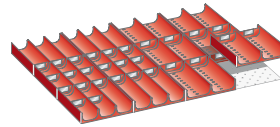

### Troughs

For front height  
mm

Art. no.

**50**      **100.313.000**

6 troughs:      3-piece, Ø 45 mm\*  
20 trough dividers: 3-piece, Ø 45 mm\*  
6 troughs:      2-piece, Ø 70 mm\*  
10 trough dividers: 2-piece, Ø 70 mm\*

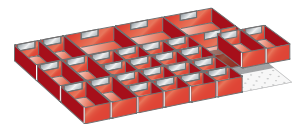

### Plastic boxes

For front height  
mm

Art. no.

**50**      **100.290.000**

**75**      **100.291.000**

16 plastic boxes: 75 × 75 mm  
8 plastic boxes: 150 × 75 mm  
4 plastic boxes: 150 × 150 mm

\*Take the usable height of the drawer into account according to the goods to be stored.

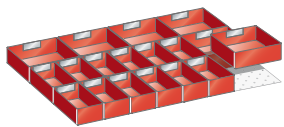

### Plastic boxes

For front height  
mm

Art. no.

**50**      **100.292.000**

**75**      **100.293.000**

**100, 125**      **100.294.000**

12 plastic boxes: 150 × 75 mm  
6 plastic boxes: 150 × 150 mm

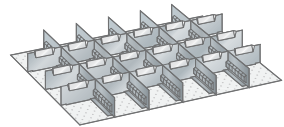

### Slotted partitions and metal dividers

For front height  
mm

Art. no.

**50**      **100.950.000**

**75**      **100.951.000**

**100, 125**      **100.952.000**

**150**      **100.953.000**

5 slotted partitions: 27 E  
18 metal dividers: 6 E

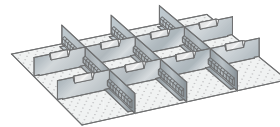

### Slotted partitions and metal dividers

For front height  
mm

Art. no.

**50**      **80.649.000**

**75**      **100.314.000**

**100, 125**      **80.651.000**

**150**      **80.652.000**

**200**      **80.653.000**

**250**      **80.654.000**

3 slotted partitions: 27 E  
8 metal dividers: 9 E

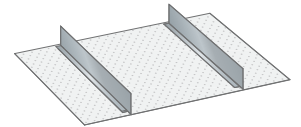

### Dividers

For front height  
mm

Art. no.

**75**      **100.315.000**

**100, 125**      **100.130.000**

**150**      **100.131.000**

**200**      **100.132.000**

**250**      **100.133.000**

2 dividers      27 E

**54 × 27 E**  918 × 459 mm

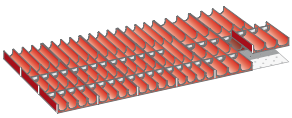

**Troughs**

For front height mm	Art. no.
<b>75</b>	<b>80.001.000</b>
12 troughs:	4-piece, Ø 33 mm*
30 trough dividers:	4-piece, Ø 33 mm*
6 troughs:	3-piece, Ø 45 mm*
10 trough dividers:	3-piece, Ø 45 mm*

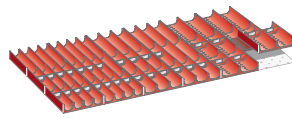

**Troughs**

For front height mm	Art. no.
<b>75, 100, 125</b>	<b>80.002.000</b>
6 troughs:	4-piece, Ø 33 mm*
20 trough dividers:	4-piece, Ø 33 mm*
6 troughs:	3-piece, Ø 45 mm*
10 trough dividers:	3-piece, Ø 45 mm*
6 troughs:	2-piece, Ø 70 mm*
10 trough dividers:	2-piece, Ø 70 mm*

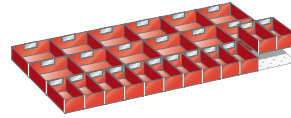

**Plastic boxes**

For front height mm	Art. no.
<b>50</b>	<b>80.045.000</b>
<b>75</b>	<b>80.046.000</b>
<b>100, 125</b>	<b>80.047.000</b>
12 plastic boxes:	150 × 75 mm
12 plastic boxes:	150 × 150 mm

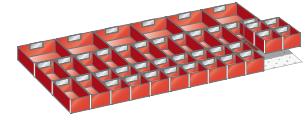

**Plastic boxes**

For front height mm	Art. no.
<b>50</b>	<b>80.043.000</b>
<b>75</b>	<b>80.044.000</b>
20 plastic boxes:	75 × 75 mm
14 plastic boxes:	150 × 75 mm
6 plastic boxes:	150 × 150 mm

\* Take the usable height of the drawer into account according to the goods to be stored.

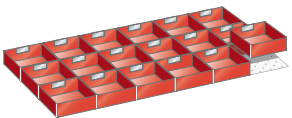

**Plastic boxes**

For front height mm	Art. no.
<b>50</b>	<b>80.419.000</b>
<b>75</b>	<b>80.049.000</b>
<b>100, 125</b>	<b>80.050.000</b>
18 plastic boxes:	150 × 150 mm

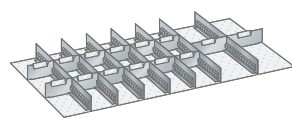

**Slotted partitions and metal dividers**

For front height mm	Art. no.
<b>50</b>	<b>80.003.000</b>
<b>75</b>	<b>80.004.000</b>
<b>100, 125</b>	<b>80.005.000</b>
7 slotted partitions:	27 E
12 metal dividers:	6 E
2 metal dividers:	9 E

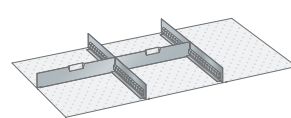

**Slotted partitions and metal dividers**

For front height mm	Art. no.
<b>50</b>	<b>80.425.000</b>
<b>75</b>	<b>80.426.000</b>
<b>100, 125</b>	<b>80.427.000</b>
<b>150</b>	<b>80.428.000</b>
<b>200</b>	<b>80.429.000</b>
<b>250</b>	<b>80.430.000</b>
<b>300</b>	<b>80.431.000</b>

2 slotted partitions: 27 E  
2 metal dividers: 18 E

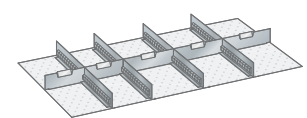

**Slotted partitions and metal dividers**

For front height mm	Art. no.
<b>50</b>	<b>80.015.000</b>
<b>75</b>	<b>80.016.000</b>
<b>100, 125</b>	<b>80.017.000</b>
<b>150</b>	<b>80.018.000</b>
<b>200</b>	<b>80.019.000</b>
<b>250</b>	<b>80.020.000</b>
<b>300</b>	<b>80.696.000</b>

4 slotted partitions: 27 E  
2 metal dividers: 9 E  
3 metal dividers: 12 E

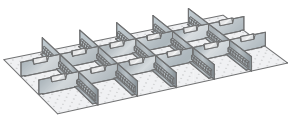

**Slotted partitions and metal dividers**

For front height mm	Art. no.
<b>50</b>	<b>80.009.000</b>
<b>75</b>	<b>80.010.000</b>
<b>100, 125</b>	<b>80.011.000</b>
<b>150</b>	<b>80.012.000</b>
<b>200</b>	<b>80.013.000</b>
<b>250</b>	<b>80.014.000</b>
<b>300</b>	<b>80.697.000</b>

5 slotted partitions: 27 E  
12 metal dividers: 9 E

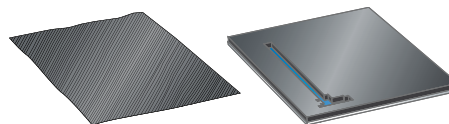

» Non-slip mats and PE foam inserts, see p. 267

**Note**

The front height is the same as the height of the drawer front. For the actual height of the partition material see p. 262–265.

Partition material sets excluding clip-on label holder.

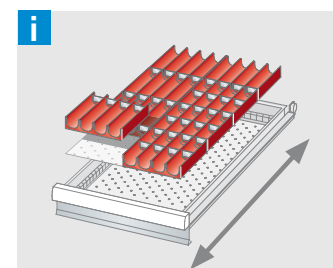

**Correct use of partition material**

Troughs should always be inserted in the running direction of the drawers to prevent round parts, such as drills or similar, from falling out when the drawers are closed forcefully.

**18 × 36 E**

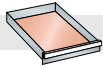

306 × 612 mm

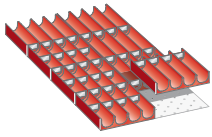

### Troughs

For front height mm	Art. no.
<b>50</b>	<b>80.618.000</b>
8 troughs:	4-piece, Ø 33 mm*
40 trough dividers:	4-piece, Ø 33 mm*

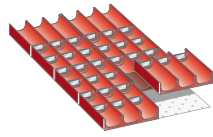

### Troughs

For front height mm	Art. no.
<b>50</b>	<b>80.619.000</b>
8 troughs:	3-piece, Ø 45 mm*
30 trough dividers:	3-piece, Ø 45 mm*

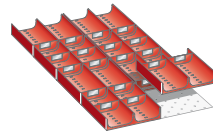

### Troughs

For front height mm	Art. no.
<b>50</b>	<b>80.620.000</b>
8 troughs:	2-piece, Ø 70 mm*
20 trough dividers:	2-piece, Ø 70 mm*

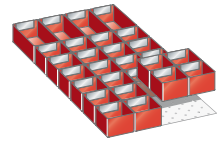

### Plastic boxes

For front height mm	Art. no.
<b>50</b>	<b>80.621.000</b>
<b>75</b>	<b>80.622.000</b>
24 plastic boxes:	75 × 75 mm
4 plastic boxes:	150 × 75 mm

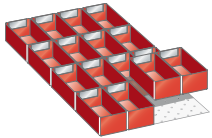

### Plastic boxes

For front height mm	Art. no.
<b>50</b>	<b>80.623.000</b>
<b>75</b>	<b>80.624.000</b>
<b>100</b>	<b>80.625.000</b>
16 plastic boxes:	150 × 75 mm

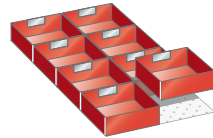

### Plastic boxes

For front height mm	Art. no.
<b>50</b>	<b>80.626.000</b>
<b>75</b>	<b>80.627.000</b>
<b>100</b>	<b>80.628.000</b>
8 plastic boxes:	150 × 150 mm

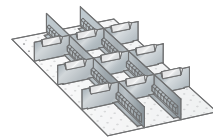

### Slotted partitions and metal dividers

For front height mm	Art. no.
<b>50</b>	<b>80.629.000</b>
<b>75</b>	<b>80.630.000</b>
<b>100</b>	<b>80.631.000</b>
<b>150</b>	<b>80.632.000</b>
2 slotted partitions:	36 E
9 metal dividers:	6 E

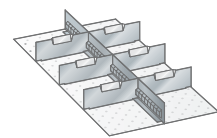

### Slotted partitions and metal dividers

For front height mm	Art. no.
<b>50</b>	<b>80.633.000</b>
<b>75</b>	<b>80.634.000</b>
<b>100</b>	<b>80.635.000</b>
<b>150</b>	<b>80.636.000</b>
<b>200</b>	<b>80.637.000</b>
<b>300</b>	<b>80.638.000</b>
1 slotted partition:	36 E
6 metal dividers:	9 E





**27 × 36 E**

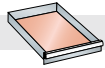

459 × 612 mm

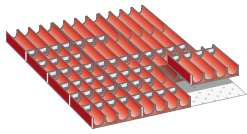

**Troughs**

For front height mm	Art. no.
<b>50</b>	<b>100.283.000</b>

12 troughs: 4-piece, Ø 33 mm\*  
50 trough dividers: 4-piece, Ø 33 mm\*

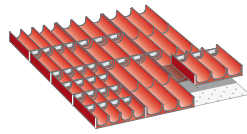

**Troughs**

For front height mm	Art. no.
<b>50</b>	<b>100.284.000</b>

4 troughs: 4-piece, Ø 33 mm\*  
20 trough dividers: 4-piece, Ø 33 mm\*  
8 troughs: 3-piece, Ø 45 mm\*  
10 trough dividers: 3-piece, Ø 45 mm\*

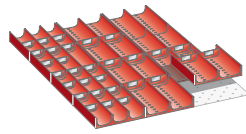

**Troughs**

For front height mm	Art. no.
<b>50</b>	<b>100.286.000</b>

4 troughs: 3-piece, Ø 45 mm\*  
20 trough dividers: 3-piece, Ø 45 mm\*  
8 troughs: 2-piece, Ø 70 mm\*  
10 trough dividers: 2-piece, Ø 70 mm\*

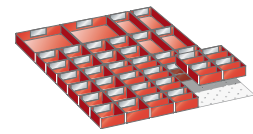

**Plastic boxes**

For front height mm	Art. no.
<b>50</b>	<b>100.288.000</b>

16 plastic boxes with  
centre divider: 75 × 75 mm  
16 plastic boxes: 75 × 75 mm  
4 plastic boxes: 150 × 75 mm  
2 plastic boxes: 150 × 150 mm

\* Take the usable height of the drawer into account according to the goods to be stored.

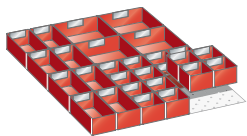

**Plastic boxes**

For front height mm	Art. no.
<b>50</b>	<b>100.290.000</b>
<b>75</b>	<b>100.291.000</b>

16 plastic boxes: 75 × 75 mm  
8 plastic boxes: 150 × 75 mm  
4 plastic boxes: 150 × 150 mm

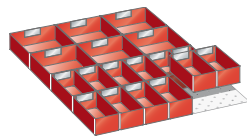

**Plastic boxes**

For front height mm	Art. no.
<b>50</b>	<b>100.292.000</b>
<b>75</b>	<b>100.293.000</b>
<b>100, 125</b>	<b>100.294.000</b>

12 plastic boxes: 150 × 75 mm  
6 plastic boxes: 150 × 150 mm

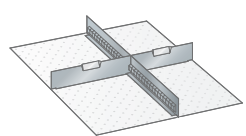

**Slotted partitions and metal dividers**

For front height mm	Art. no.
<b>75</b>	<b>100.270.000</b>
<b>100, 125</b>	<b>100.271.000</b>
<b>150</b>	<b>100.272.000</b>
<b>200</b>	<b>100.273.000</b>
<b>250</b>	<b>80.691.000</b>

1 slotted partition: 36 E  
1 metal divider: 12 E  
1 metal divider: 15 E

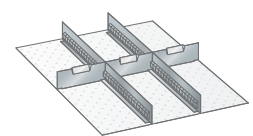

**Slotted partitions and metal dividers**

For front height mm	Art. no.
<b>75</b>	<b>100.275.000</b>
<b>100, 125</b>	<b>100.276.000</b>
<b>150</b>	<b>100.277.000</b>
<b>200</b>	<b>100.278.000</b>
<b>250</b>	<b>80.692.000</b>

2 slotted partitions: 36 E  
3 metal dividers: 9 E

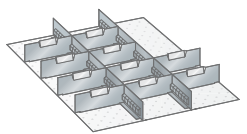

**Slotted partitions and metal dividers**

For front height mm	Art. no.
<b>50</b>	<b>100.244.000</b>
<b>75</b>	<b>100.245.000</b>
<b>100, 125</b>	<b>100.246.000</b>
<b>150</b>	<b>100.247.000</b>

2 slotted partitions: 36 E  
10 metal dividers: 9 E

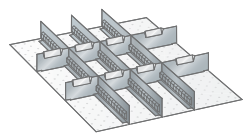

**Slotted partitions and metal dividers**

For front height mm	Art. no.
<b>50</b>	<b>100.249.000</b>
<b>75</b>	<b>100.250.000</b>
<b>100, 125</b>	<b>100.251.000</b>
<b>150</b>	<b>100.252.000</b>

3 slotted partitions: 36 E  
6 metal dividers: 6 E  
2 metal dividers: 9 E

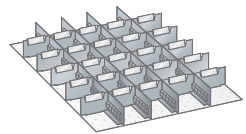

**Slotted partitions and metal dividers**

For front height mm	Art. no.
<b>50</b>	<b>100.234.000</b>
<b>75</b>	<b>100.235.000</b>
<b>100, 125</b>	<b>100.236.000</b>

4 slotted partitions: 36 E  
15 metal dividers: 5 E  
10 metal dividers: 6 E

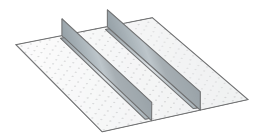

**Dividers**

For front height mm	Art. no.
<b>75</b>	<b>100.265.000</b>
<b>100, 125</b>	<b>100.266.000</b>
<b>150</b>	<b>100.267.000</b>
<b>200</b>	<b>100.268.000</b>
<b>250</b>	<b>80.695.000</b>

2 dividers: 36 E

**Note**

The front height is the same as the height of the drawer front. For the actual height of the partition material see p. 262–265.

Partition material sets excluding clip-on label holder.

**36 × 36 E**

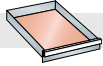

612 × 612 mm

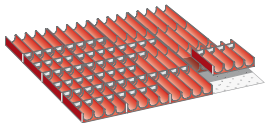

### Troughs

For front height mm	Art. no.
<b>50</b>	<b>100.317.000</b>

16 troughs: 4-piece, Ø 33 mm\*  
70 trough dividers: 4-piece, Ø 33 mm\*

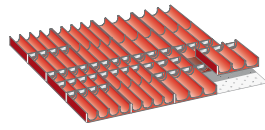

### Troughs

For front height mm	Art. no.
<b>50</b>	<b>100.318.000</b>

8 troughs: 4-piece, Ø 33 mm\*  
30 trough dividers: 4-piece, Ø 33 mm\*  
8 troughs: 3-piece, Ø 45 mm\*  
20 trough dividers: 3-piece, Ø 45 mm\*

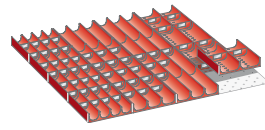

### Troughs

For front height mm	Art. no.
<b>50</b>	<b>100.319.000</b>

4 troughs: 4-piece, Ø 33 mm\*  
30 trough dividers: 4-piece, Ø 33 mm\*  
8 troughs: 3-piece, Ø 45 mm\*  
20 trough dividers: 3-piece, Ø 45 mm\*  
4 troughs: 2-piece, Ø 70 mm\*  
10 trough dividers: 2-piece, Ø 70 mm\*

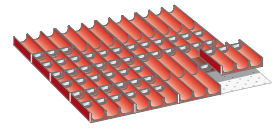

### Troughs

For front height mm	Art. no.
<b>50</b>	<b>100.320.000</b>

16 troughs: 3-piece, Ø 45 mm\*  
60 trough dividers: 3-piece, Ø 45 mm\*

\* Take the usable height of the drawer into account according to the goods to be stored.

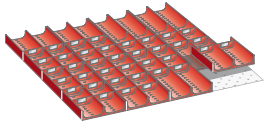

### Troughs

For front height mm	Art. no.
<b>50</b>	<b>100.322.000</b>

16 troughs: 2-piece, Ø 70 mm\*  
40 trough dividers: 2-piece, Ø 70 mm\*

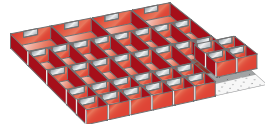

### Plastic boxes

For front height mm	Art. no.
<b>50</b>	<b>100.380.000</b>
<b>75</b>	<b>100.381.000</b>

16 plastic boxes: 75 × 75 mm  
16 plastic boxes: 150 × 75 mm  
4 plastic boxes: 150 × 150 mm

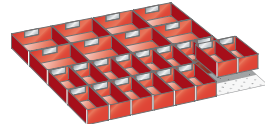

### Plastic boxes

For front height mm	Art. no.
<b>50</b>	<b>100.389.000</b>
<b>75</b>	<b>100.390.000</b>
<b>100, 125</b>	<b>100.391.000</b>

16 plastic boxes: 150 × 75 mm  
8 plastic boxes: 150 × 150 mm

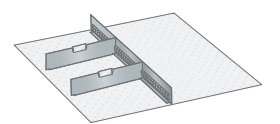

### Slotted partitions and metal dividers

For front height mm	Art. no.
<b>100, 125</b>	<b>100.354.000</b>
<b>150</b>	<b>100.355.000</b>
<b>200</b>	<b>100.356.000</b>
<b>250</b>	<b>80.688.000</b>
<b>300</b>	<b>100.357.000</b>

1 slotted partition: 36 E  
2 metal dividers: 18 E

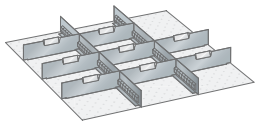

### Slotted partitions and metal dividers

For front height mm	Art. no.
<b>75</b>	<b>100.348.000</b>
<b>100, 125</b>	<b>100.349.000</b>
<b>150</b>	<b>100.350.000</b>
<b>200</b>	<b>100.351.000</b>

2 slotted partitions: 36 E  
8 metal dividers: 12 E

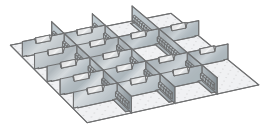

### Slotted partitions and metal dividers

For front height mm	Art. no.
<b>75</b>	<b>100.343.000</b>
<b>100, 125</b>	<b>100.344.000</b>
<b>150</b>	<b>100.345.000</b>
<b>200</b>	<b>100.346.000</b>
<b>250</b>	<b>80.689.000</b>

3 slotted partitions: 36 E  
15 metal dividers: 9 E

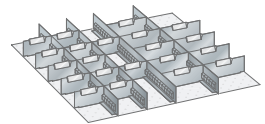

### Slotted partitions and metal dividers

For front height mm	Art. no.
<b>50</b>	<b>100.333.000</b>
<b>75</b>	<b>100.334.000</b>
<b>100, 125</b>	<b>100.335.000</b>

4 slotted partitions: 36 E  
12 metal dividers: 6 E  
9 metal dividers: 9 E

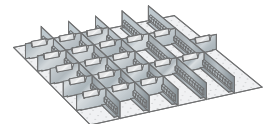

### Slotted partitions and metal dividers

For front height mm	Art. no.
<b>50</b>	<b>100.329.000</b>
<b>75</b>	<b>100.330.000</b>
<b>100, 125</b>	<b>100.331.000</b>

5 slotted partitions: 36 E  
20 metal dividers: 6 E

**45 × 36 E**

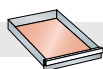

765 × 612 mm

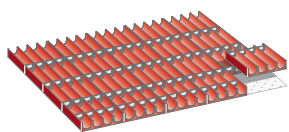

**Troughs**

For front height mm	Art. no.
<b>50</b>	<b>80.490.000</b>
20 troughs:	4-piece, Ø 33 mm*
80 trough dividers:	4-piece, Ø 33 mm*

\* Take the usable height of the drawer into account according to the goods to be stored.

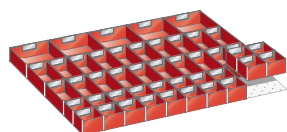

**Plastic boxes**

For front height mm	Art. no.
<b>50</b>	<b>80.496.000</b>
<b>75</b>	<b>80.497.000</b>
20 plastic boxes:	75 × 75 mm
20 plastic boxes:	150 × 75 mm
5 plastic boxes:	150 × 150 mm

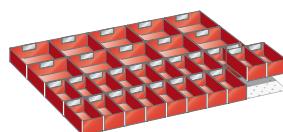

**Plastic boxes**

For front height mm	Art. no.
<b>50</b>	<b>80.498.000</b>
<b>75</b>	<b>80.499.000</b>
<b>100, 125</b>	<b>80.500.000</b>
20 plastic boxes:	150 × 75 mm
10 plastic boxes:	150 × 150 mm

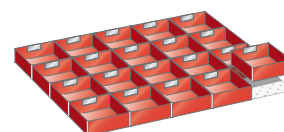

**Plastic boxes**

For front height mm	Art. no.
<b>50</b>	<b>80.501.000</b>
<b>75</b>	<b>80.502.000</b>
<b>100, 125</b>	<b>80.503.000</b>
20 plastic boxes:	150 × 150 mm

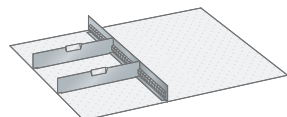

**Slotted partitions and metal dividers**

For front height mm	Art. no.
<b>100, 125</b>	<b>100.354.000</b>
<b>150</b>	<b>100.355.000</b>
<b>200</b>	<b>100.356.000</b>
<b>250</b>	<b>80.688.000</b>
<b>300</b>	<b>100.357.000</b>
1 slotted partition:	36 E
2 metal dividers:	18 E

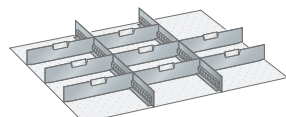

**Slotted partitions and metal dividers**

For front height mm	Art. no.
<b>100, 125</b>	<b>80.504.000</b>
<b>150</b>	<b>80.505.000</b>
<b>200</b>	<b>80.506.000</b>
<b>250</b>	<b>80.507.000</b>
<b>300</b>	<b>80.508.000</b>
2 slotted partitions:	36 E
8 metal dividers:	15 E

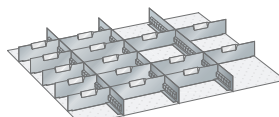

**Slotted partitions and metal dividers**

For front height mm	Art. no.
<b>75</b>	<b>80.509.000</b>
<b>100, 125</b>	<b>80.510.000</b>
<b>150</b>	<b>80.511.000</b>
<b>200</b>	<b>80.512.000</b>
3 slotted partitions:	36 E
5 metal dividers:	9 E
10 metal dividers:	12 E

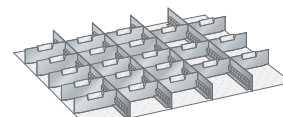

**Slotted partitions and metal dividers**

For front height mm	Art. no.
<b>75</b>	<b>80.513.000</b>
<b>100, 125</b>	<b>80.514.000</b>
<b>150</b>	<b>80.515.000</b>
<b>200</b>	<b>80.516.000</b>
<b>250</b>	<b>80.517.000</b>
4 slotted partitions:	36 E
21 metal dividers:	9 E



**Note**

The front height is the same as the height of the drawer front. For the actual height of the partition material see p. 262–265.

Partition material sets excluding clip-on label holder.

**54 × 36 E**

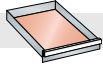

918 × 612 mm

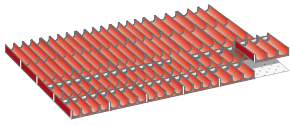

### Troughs

For front height mm	Art. no.
<b>50</b>	<b>80.387.000</b>
16 troughs:	4-piece, Ø 33 mm*
30 trough dividers:	4-piece, Ø 33 mm*
8 troughs:	3-piece, Ø 45 mm*
10 trough dividers:	3-piece, Ø 45 mm*

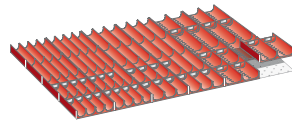

### Troughs

For front height mm	Art. no.
<b>50</b>	<b>80.388.000</b>
8 troughs:	4-piece, Ø 33 mm*
20 trough dividers:	4-piece, Ø 33 mm*
8 troughs:	3-piece, Ø 45 mm*
10 trough dividers:	3-piece, Ø 45 mm*
8 troughs:	2-piece, Ø 70 mm*
10 trough dividers:	2-piece, Ø 70 mm*

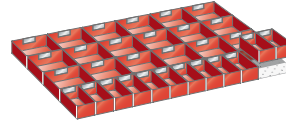

### Plastic boxes

For front height mm	Art. no.
<b>50</b>	<b>80.449.000</b>
<b>75</b>	<b>80.405.000</b>
<b>100, 125</b>	<b>80.406.000</b>
12 plastic boxes:	150 × 75 mm
18 plastic boxes:	150 × 150 mm

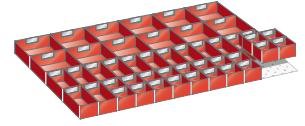

### Plastic boxes

For front height mm	Art. no.
<b>50</b>	<b>80.450.000</b>
<b>75</b>	<b>80.407.000</b>
20 plastic boxes:	75 × 75 mm
14 plastic boxes:	150 × 75 mm
12 plastic boxes:	150 × 150 mm

\*Take the usable height of the drawer into account according to the goods to be stored.

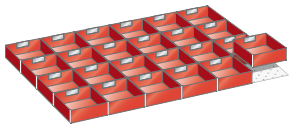

### Plastic boxes

For front height mm	Art. no.
<b>50</b>	<b>80.451.000</b>
<b>75</b>	<b>80.452.000</b>
<b>100, 125</b>	<b>80.453.000</b>
24 plastic boxes:	150 × 150 mm

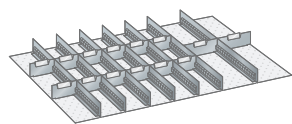

### Slotted partitions and metal dividers

For front height mm	Art. no.
<b>50</b>	<b>80.481.000</b>
<b>75</b>	<b>80.403.000</b>
<b>100, 125</b>	<b>80.404.000</b>
7 slotted partitions:	36 E
12 metal dividers:	6 E
2 metal dividers:	9 E

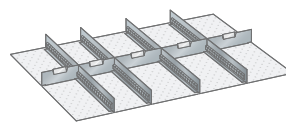

### Slotted partitions and metal dividers

For front height mm	Art. no.
<b>50</b>	<b>80.533.000</b>
<b>75</b>	<b>80.389.000</b>
<b>100, 125</b>	<b>80.390.000</b>
<b>150</b>	<b>80.391.000</b>
<b>200</b>	<b>80.392.000</b>
<b>250</b>	<b>80.393.000</b>
<b>300</b>	<b>80.394.000</b>

4 slotted partitions: 36 E  
2 metal dividers: 9 E  
3 metal dividers: 12 E

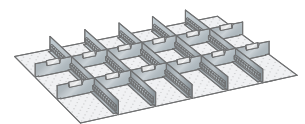

### Slotted partitions and metal dividers

For front height mm	Art. no.
<b>50</b>	<b>80.479.000</b>
<b>75</b>	<b>80.395.000</b>
<b>100, 125</b>	<b>80.396.000</b>
<b>150</b>	<b>80.397.000</b>
<b>200</b>	<b>80.398.000</b>
<b>250</b>	<b>80.399.000</b>
<b>300</b>	<b>80.400.000</b>

5 slotted partitions: 36 E  
12 metal dividers: 9 E

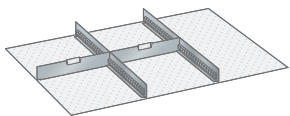

### Dividers

For front height mm	Art. no.
<b>50</b>	<b>80.457.000</b>
<b>75</b>	<b>80.458.000</b>
<b>100, 125</b>	<b>80.459.000</b>
<b>150</b>	<b>80.460.000</b>
<b>200</b>	<b>80.461.000</b>
<b>250</b>	<b>80.462.000</b>
<b>300</b>	<b>80.463.000</b>

2 slotted partitions: 36 E  
2 metal dividers: 18 E

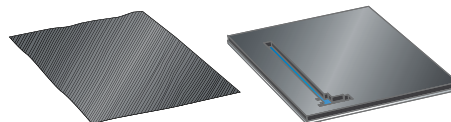

» Non-slip mats and PE foam inserts, see p. 267

### Note

The front height is the same as the height of the drawer front. For the actual height of the partition material see p. 262–265.

Partition material sets excluding clip-on label holder.

**64 × 36 E**

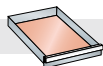

1088 × 612 mm

**78 × 36 E**

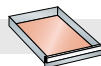

1326 × 612 mm

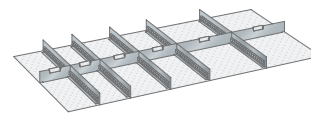
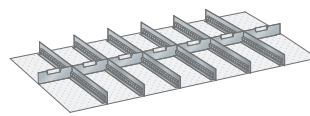
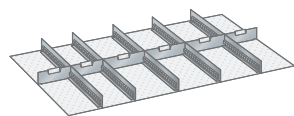
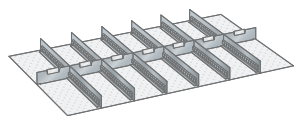

**Slotted partitions and metal dividers**

For front height mm	Art. no.
50	80.600.000
100, 125	80.601.000
150	80.602.000

6 slotted partitions: 36 E  
6 metal dividers: 9 E  
1 metal divider: 10 E

**Slotted partitions and metal dividers**

For front height mm	Art. no.
75	80.603.000
100, 125	80.604.000
150	80.605.000

5 slotted partitions: 36 E  
2 metal dividers: 9 E  
3 metal dividers: 12 E  
1 metal divider: 10 E

**Slotted partitions and metal dividers**

For front height mm	Art. no.
75	80.553.000
100, 125	80.554.000
150	80.555.000

6 slotted partitions: 36 E  
4 metal dividers: 9 E  
2 metal dividers: 12 E  
1 metal divider: 18 E

**Slotted partitions and metal dividers**

For front height mm	Art. no.
75	80.556.000
100, 125	80.557.000
150	80.558.000

5 slotted partitions: 36 E  
2 metal dividers: 9 E  
2 metal dividers: 12 E  
2 metal dividers: 18 E



# Partition material | Slotted partitions, metal dividers and dividers



## Slotted partitions, both sides

For lengthwise partitioning of drawers in combination with metal dividers. Specification: Steel sheet, colour: Grey, NCS S 4502-B.

## Metal dividers

Together with the slotted partitions, they can be used to subdivide the drawers as desired. Specification: Aluminium

## Dividers

For lengthwise and crosswise partitioning of drawers. Specification: Steel sheet, colour: Grey, NCS S 4502-B.

**H** ↑ Drawer front height  
mm

**W<sub>i</sub>** → Length  
mm

### Dividers

18 E	304
27 E	456
36 E	610
45 E	762
54 E	915
64 E	1085
78 E	1323

**D<sub>1</sub>** ↗ Length  
mm

### Slotted partitions, both sides

27 E	456
36 E	610

**Metal dividers** **W<sub>i</sub>** →

3 E	48
4 E	65
5 E	82
6 E	98
7 E	116
8 E	133
9 E	149
10 E	167
12 E	201
15 E	252
18 E	303

## How do I use the slotted partitions, metal dividers and dividers in my LISTA drawer?

Example: for drawer units 45 × 36 E (765 × 612 mm)

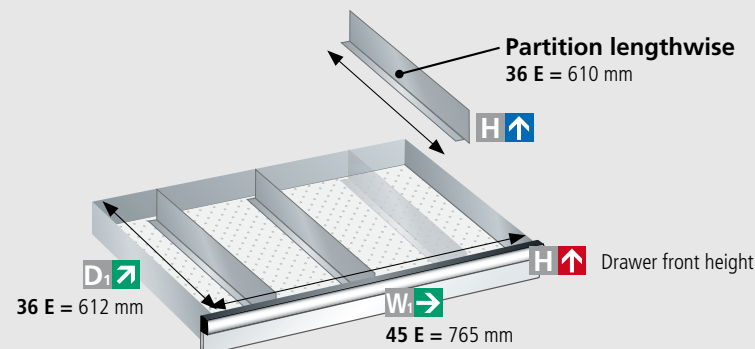
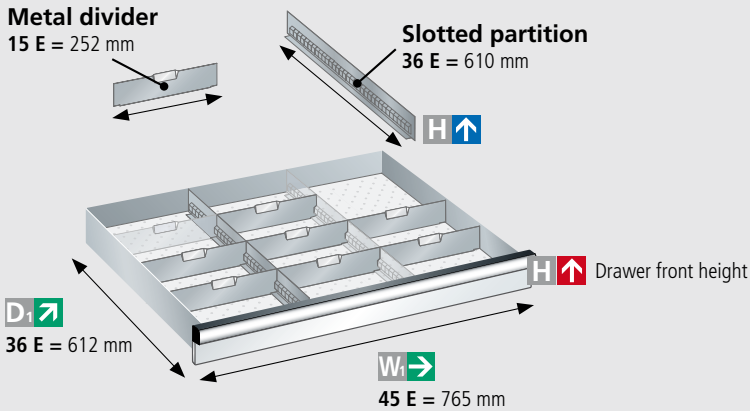

50 mm	75 mm	100, 125 mm	150 mm	200 mm	250 mm	300 mm
31,5	50	75	125	175	225	275
Art. no.	Art. no.	Art. no.	Art. no.	Art. no.	Art. no.	Art. no.
<b>1 pcs/set</b>	<b>1 pcs/set</b>	<b>1 pcs/set</b>	<b>1 pcs/set</b>	<b>1 pcs/set</b>	<b>1 pcs/set</b>	<b>1 pcs/set</b>
12.088.000	12.121.000	12.089.000	12.090.000	12.122.000	-	12.091.000
80.237.000	80.121.000	80.127.000	80.133.000	80.139.000	80.222.000	80.243.000
80.239.000	80.123.000	80.129.000	80.135.000	80.141.000	80.225.000	80.144.000
80.541.000	80.542.000	80.543.000	80.544.000	80.545.000	80.546.000	80.547.000
80.178.000	80.179.000	80.180.000	80.181.000	80.182.000	80.183.000	80.184.000
-	80.124.000	80.130.000	80.136.000	80.142.000	80.228.000	80.229.000
-	80.125.000	80.131.000	80.137.000	80.143.000	80.685.000	80.233.000
Art. no.	Art. no.	Art. no.	Art. no.	Art. no.	Art. no.	Art. no.
<b>5 pcs/set</b>	<b>5 pcs/set</b>	<b>5 pcs/set</b>	<b>5 pcs/set</b>	<b>3 pcs/set</b>	<b>3 pcs/set</b>	<b>3 pcs/set</b>
80.307.000	80.308.000	80.309.000	80.310.000	80.311.000	80.312.000	80.313.000
80.314.000	80.315.000	80.316.000	80.317.000	80.318.000	80.319.000	80.320.000
Art. no.	Art. no.	Art. no.	Art. no.	Art. no.	Art. no.	Art. no.
<b>5 pcs/set</b>	<b>5 pcs/set</b>	<b>5 pcs/set</b>	<b>5 pcs/set</b>	<b>5 pcs/set</b>	<b>5 pcs/set</b>	<b>5 pcs/set</b>
95.261.000	95.272.000	95.302.000	-	-	-	-
95.262.000	95.273.000	95.303.000	-	-	-	-
95.263.000	95.274.000	95.304.000	-	-	-	-
95.264.000	95.275.000	95.305.000	95.313.000	-	-	-
95.265.000	95.276.000	95.306.000	95.314.000	95.321.000	-	-
95.266.000	95.277.000	95.307.000	95.315.000	95.322.000	95.328.000	-
95.267.000	95.278.000	95.308.000	95.316.000	95.323.000	95.329.000	95.368.000
95.268.000	95.279.000	95.309.000	95.317.000	95.324.000	95.330.000	95.369.000
95.269.000	95.280.000	95.310.000	95.318.000	95.325.000	95.365.000	95.370.000
95.270.000	95.300.000	95.311.000	95.319.000	95.326.000	95.366.000	95.371.000
95.271.000	95.301.000	95.312.000	95.320.000	95.327.000	95.367.000	95.372.000
					<b>10 pcs/set</b>	
					<b>134.002.000</b>	

Extruded screws for metal dividers: Screws for fastening the metal dividers to the drawer bottom.

### Clip-on label holders for slotted partitions

for fitting into all slotted partitions and the inner slots of the drawer fronts. Labels not included.



Label size (W × H) mm	Quantity	Art. no.
27 × 12	<b>10 holders</b>	<b>80.305.000</b>
47 × 12	<b>10 holders</b>	<b>80.306.000</b>

### Clip-on label holders for slotted partitions, metal dividers and divider including labels.



Label size (W × H) mm	Quantity	Art. no.
27 × 12	<b>20 tabs</b>	<b>134.029.000</b>
47 × 12 (size 5 E)	<b>20 tabs</b>	<b>134.049.000</b>
47 × 18 (size 5 E)	<b>20 tabs</b>	<b>134.052.000</b>

### Barcode holder including protective shield for slotted partitions, metal dividers and dividers including labels.

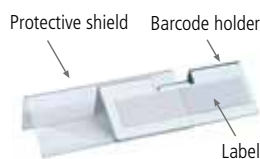

Label size (W × H) mm	For drawer front height mm	Quantity	Art. no.
47 × 12	50 to 300	<b>10</b>	<b>80.321.000</b>
62 × 12	50 to 300	<b>10</b>	<b>80.322.000</b>
62 × 21,8	50 to 300	<b>10</b>	<b>80.323.000</b>
62 × 29	75 to 300	<b>10</b>	<b>80.324.000</b>

### LISTA-Script labels "Standard pack"

The labelling software can be downloaded from the LISTA website [www.lista.com](http://www.lista.com) under Products › Accessories › LISTA Script.



Label size (W × H) mm	Quantity	Art. no.
210 × 22 / 70 × 22	<b>2 sheets</b>	<b>80.325.000</b>
47 × 12	<b>76 labels</b>	
47 × 18	<b>52 labels</b>	
27 × 12	<b>133 labels</b>	

# Partition material | Plastic boxes and troughs



Especially suitable for drawers with a front height of: 50, 75, 100, 125 mm

## How can I partition my LISTA drawer?

Example: Plastic boxes and troughs for drawers 36 × 27 E (612 × 459 mm)

\* The plastic box also has a fixed centre divider.

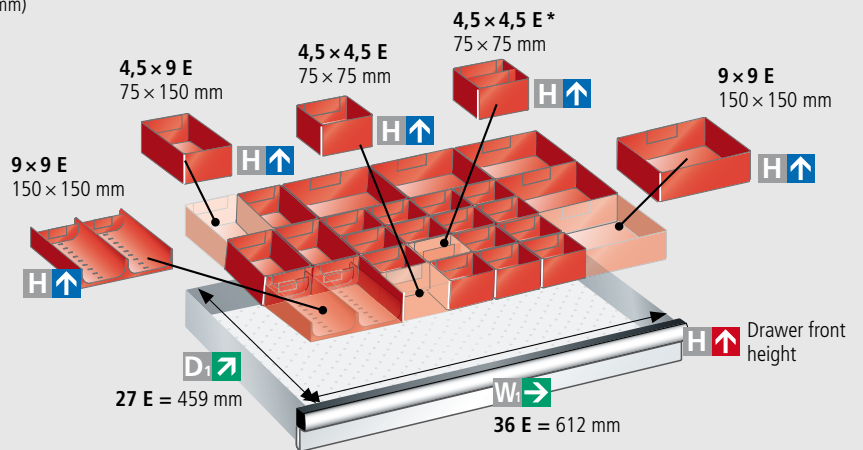
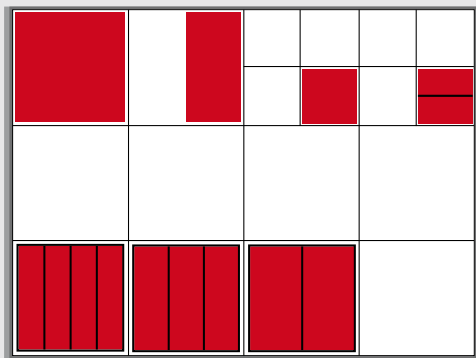

### Perfect drawer partitioning

Store your small and round parts professionally and perfectly in the LISTA drawers with LISTA plastic boxes and troughs.

The table on the right shows the maximum capacity of your drawer for each size of plastic boxes and troughs. The dimensions are standardised but can be combined if desired and fit into any LISTA drawer.

**Please bear the front height of your drawer in mind (external dimension)!**

#### Maximum capacity per plastic box for:

9 × 9 E  
150 × 150 mm

Number of plastic boxes/troughs

4,5 × 9 E  
75 × 150 mm

Number of plastic boxes

4,5 × 4,5 E  
75 × 75 mm

Number of plastic boxes

#### Drawer units (E)

Drawer units (E)	Dimensions	9 × 9 E 150 × 150 mm	4,5 × 9 E 75 × 150 mm	4,5 × 4,5 E 75 × 75 mm
18 × 27	306 × 459 mm	6	12	24
27 × 27	459 × 459 mm	9	18	36
36 × 27	612 × 459 mm	12	24	48
54 × 27	918 × 459 mm	18	36	72
18 × 36	306 × 612 mm	8	16	32
27 × 36	459 × 612 mm	12	24	48
36 × 36	612 × 612 mm	16	32	64
45 × 36	765 × 612 mm	20	40	80
54 × 36	918 × 612 mm	24	48	96
64 × 36	1088 × 612 mm	28	56	112
78 × 36	1326 × 612 mm	32	68	136



### Plastic boxes, standard



	9 × 9 E	4,5 × 9 E	4,5 × 4,5 E	4,5 × 4,5 E
	150 × 150 mm	75 × 150 mm	75 × 75 mm	75 × 75 mm
Art. no.				
	6 pcs/set	6 pcs/set	12 pcs/set	12 pcs/set
	80.187.000	80.191.000	80.189.000	80.185.000*
	80.186.000	80.190.000	80.188.000	-
	80.192.000	80.193.000	-	-

**H** ↑ Drawer front height (mm)      **H** ↑ Height (mm)

50	26
75	46
100	71

\* The plastic box Art. no. 80.185.000 also has a fixed centre divider.

### Troughs, standard



Specification

**Troughs, 9 × 9 E, 6 pieces**  
**Dividers, 10 pieces**

6 pcs/set
10 pcs/set

9 × 9 E (150 × 150 mm)			
	Ø 33 mm, 4 troughs	Ø 45 mm, 3 troughs	Ø 70 mm, 2 troughs
Art. no.			
	80.196.000	80.195.000	80.194.000
	134.044.000	134.040.000	134.020.000

» Plastic boxes/troughs also available in ESD.

**N.B.:** Take the usable height of the drawer into account according to the goods to be stored.

### Clip-on label holders for plastic boxes

for inserting into the groove on the plastic boxes.  
Including labels and transparent sheets.



Label size (W × H) mm	Quantity	Art. no.
47 × 12	20 tabs	134.034.000

### Clip-on label holders for dividers

fit directly onto the dividers. Including paper and transparent sheet.



Label size (W × H) mm	Quantity	Art. no.
27 × 12	20 tabs	134.029.000
47 × 12 (Ø 70 mm)	20 tabs	134.049.000

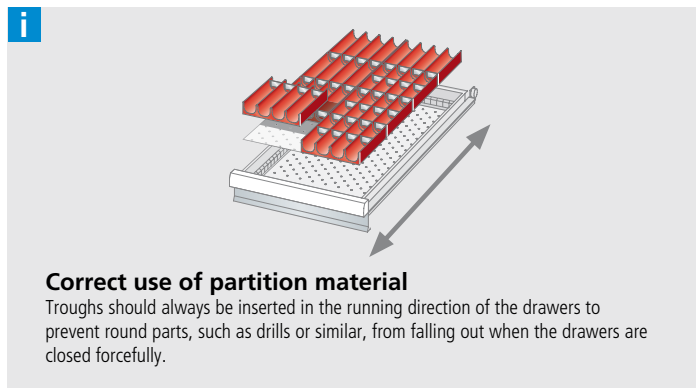

### LISTA-Script labels "Standard pack"

The labelling software can be downloaded from the LISTA website [www.lista.com](http://www.lista.com) under Products > Accessories > LISTA Script.



Label size (W × H) mm	Quantity	Art. no.
210 × 22 / 70 × 22	2 sheets	80.325.000
47 × 12	76 labels	
47 × 18	52 labels	
27 × 12	133 labels	

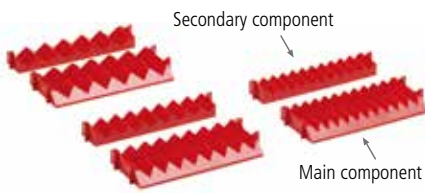

## Pairs of grooved inserts

Consisting of main and secondary components. They are attached by inserting between two slotted partitions. They can be divided by metal separators. Main components slotted for dividing into small compartments or marking with label holders. Specification: ABS plastic. Colour: red. Main component: width 153 mm/9 E, depth 68 mm/4 E. Secondary component: width 153 mm/9 E, depth 34 mm/2 E.

Number of grooves	Max. tool Ø mm	Art. no.
6	20,5	<b>80.078.000</b>
8	15	<b>80.079.000</b>
11	10	<b>80.080.000</b>

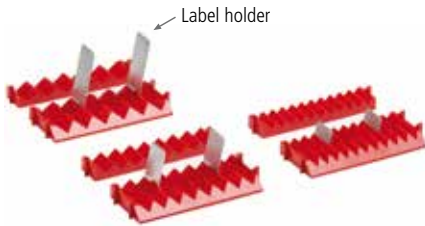

## Label holders

Specification: aluminium, for labelling.

Width mm	Height mm	Art. no.
29	25	<b>100.527.000</b>
29	50	<b>100.521.000</b>
29	75	<b>100.522.000</b>



## Milling cutter holder, height 26 mm

The milling cutter holders can be lengthened as desired by screwing them on top of one another. They are screwed onto the perforated drawer bottom. Including screw nuts. Specification: ABS plastic. Colour: red.

For tool bore (DIN) Ø mm	Ø mm	Inch	Number	Art. no.
13	12,2	1/2	<b>5</b>	<b>80.765.000</b>
16	15,5	-	<b>5</b>	<b>80.766.000</b>
22	21,5	-	<b>5</b>	<b>80.767.000</b>
25,5	25	1	<b>5</b>	<b>100.103.000</b>
27	26,5	-	<b>5</b>	<b>100.099.000</b>
32	31,2	-	<b>5</b>	<b>100.100.000</b>
38	37,5	1 1/2	<b>5</b>	<b>100.104.000</b>
40	39,5	-	<b>5</b>	<b>100.101.000</b>
50	49,5	-	<b>5</b>	<b>100.102.000</b>



## Holding pins

For positioning and holding irregularly shaped tools. The holding pins are screwed onto the perforated drawer bottom. Including screw nuts. Specification: round steel, bright galvanised.

For front height mm	Ø mm	Height mm	Number	Art. no.
50	6	27	<b>10</b>	<b>134.036.000</b>
75	6	52	<b>10</b>	<b>134.054.000</b>
100	6	77	<b>10</b>	<b>134.057.000</b>



## Pair of angular supports, height 52 mm

The pair of angular supports can be screwed horizontally or vertically onto the perforated drawer bottom. Screw fasteners included. Specification: ABS plastic. Colour: red.

Width mm	Depth mm	Art. no.
25	75	<b>80.077.000</b>

## Non-slip mats

Non-slip mats to protect delicate inventory items. For placing onto the bottom of the drawer. Specification: nylon/PVC mesh mats. Colour: anthracite.

For drawer sizes Unit (E)	Width mm	Depth mm	Thickness mm	Art. no.
<b>18 × 27</b>	300	450	3	<b>119.001.000</b>
<b>18 × 36</b>	300	600	3	<b>119.000.000</b>
<b>27 × 27</b>	450	450	3	<b>119.020.000</b>
<b>27 × 36, 36 × 27</b>	450	600	3	<b>100.396.000</b>
<b>36 × 36</b>	600	600	3	<b>100.394.000</b>
<b>45 × 36</b>	750	600	3	<b>130.743.000</b>
<b>54 × 27</b>	900	450	3	<b>119.119.000</b>
<b>54 × 36</b>	900	600	3	<b>130.745.000</b>
<b>64 × 36</b>	1080	600	3	<b>119.028.000</b>
<b>78 × 36</b>	1320	600	3	<b>119.031.000</b>



## Foam inserts

For storing very delicate or irregularly shaped parts. To achieve a snug fit, areas can be cut out of the foam with plunge cutters. Specification: polyethylene plastic. Colour: black.

For drawer sizes Unit (E)	Width mm	Depth mm	Thickness mm	Art. no.
<b>36 × 27, 27 × 36</b>	600	447	22	<b>80.917.000</b>
<b>36 × 36</b>	600	600	22	<b>80.918.000</b>
<b>54 × 27</b>	906	447	22	<b>80.923.000</b>
<b>54 × 36</b>	906	600	22	<b>80.919.000</b>
<b>78 × 36</b>	1320	600	22	<b>80.980.000</b>

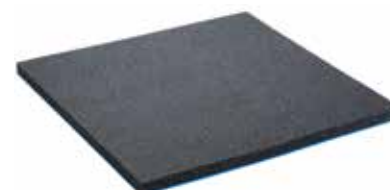
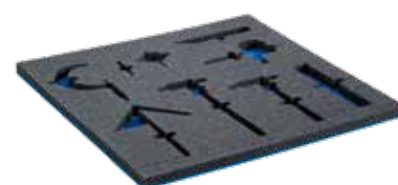

## Underlay for foam inserts

Specification: polyethylene plastic. Colour: blue.

For drawer sizes Unit (E)	Width mm	Depth mm	Thickness mm	Art. no.
<b>36 × 27, 27 × 36</b>	600	447	3	<b>80.906.000</b>
<b>36 × 36</b>	600	600	3	<b>80.907.000</b>
<b>54 × 27</b>	906	447	3	<b>80.924.000</b>
<b>54 × 36</b>	906	600	3	<b>80.908.000</b>
<b>78 × 36</b>	1320	600	3	<b>80.981.000</b>

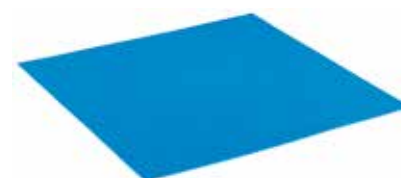

## Plunge cutter for foam inserts

For accurate cutting of the blank PE foam inserts.

Width mm	Height mm	Art. no.
<b>20</b>	80	<b>80.920.000</b>
<b>50</b>	80	<b>80.921.000</b>
<b>20 × 20 "U" shape</b>	80	<b>80.922.000</b>



# LISTA Script labelling system

With LISTA Script, your LISTA products can be simply and clearly labelled. The labelling software can be downloaded from our website. The matching labels are supplied as perforated A4 sheets suitable for any commercially available printer. There are almost no limits to the ways you can design labels. As always with LISTA.



**+ Individual labelling**  
with a wide range of labelling options, colours, pictograms and barcode generator

**+ Software can easily be downloaded**  
via [www.lista.com](http://www.lista.com) under Products › Accessories › LISTA Script

**+ Easy to use**  
with any commercially available printer and pre-perforated labels

**+ Fast data import**  
via database link

## + Easy to use in three simple steps



### 1. Design

- Design the labels using LISTA Script labelling software



### 2. Print

- Print the labels on perforated A4 sheets and detach them in the desired size



### 3. Insert

- Open the viewing window, insert the label and close the viewing window by pressing the bottom edge

## + Pre-perforated labels for cabinets and partition material

LISTA labels are available in the sizes 70 × 22 mm, 140 × 22 mm and 210 × 22 mm for cabinet labelling and 27 × 12 mm, 47 × 12 mm and 47 × 18 mm for labelling partition material.

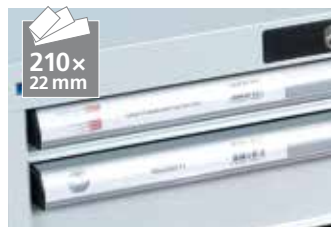

**Label size 210 × 22 mm**  
for labelling drawers



**Label size 70 × 22 mm**  
for labelling housing



**Label size 70 × 22 mm**  
for labelling drawers



**All labels**  
on perforated A4 sheets



**Label size 27 × 12 mm**  
for labelling troughs



**Label size 47 × 12 mm**  
for labelling plastic boxes

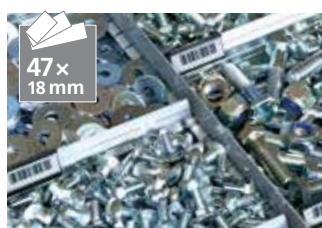

**Label size 47 × 18 mm**  
for labelling dividers

### LISTA Script labels "Standard pack"

Label size (W × H) mm							Quantity	Art. no.
210 × 22 / 70 × 22	●	●	-	-	-	-	<b>2 sheets</b>	<b>80.325.000</b>
27 × 12	-	-	●	●	●	●	<b>133 labels</b>	
47 × 12	-	-	-	●	●	●	<b>76 labels</b>	
47 × 18	-	-	-	-	●	-	<b>52 labels</b>	

#### \* Clip-on label holders

To hold clip-on label holders, for fitting into the slots inside the drawer fronts, see partition material p. 262.



#### Label strips with and without labels

For labelling shelves, clothes lockers, etc. Specification: plastic, with hinged transparent protector, self-adhesive.

Width mm	labels	Height mm	Max. font height mm	Quantity	Art. no.
105	-	22	14	<b>1</b>	<b>18.926.000</b>
210	-	22	14	<b>1</b>	<b>18.927.000</b>
1000	-	22	14	<b>1</b>	<b>18.929.000</b>
105	●	22	14	<b>10</b>	<b>18.930.000</b>
210	●	22	14	<b>10</b>	<b>18.931.000</b>

● with labels    - without labels

#### LISTA Script labels for label strips



Label size (W × H) mm	Quantity	Art. no.
52,5 × 18	<b>2 A4 sheets with 52 labels each</b>	<b>18.932.000</b>

» For drawer handles and disassembly tools, please contact us.

## THERE FOR YOU ALL OVER THE WORLD

LISTA is there for you, on several continents, in many different locations. In addition to our two plants at the headquarters in Erlen (Switzerland) and in Bergneustadt (Germany), we also look after and advise our customers through our international sales branches in Europe and China. A close-knit network of retail partners tops off the service that we offer.



### LISTA Group locations

Switzerland, Germany, Austria, France, Italy, England, Spain, China



### Founding

1945

### Headquarters

Erlen (TG), Switzerland



### Production sites

Erlen (CH), Bergneustadt (DE)

## ORDERING AND CONTACT

Lista AG  
Switzerland

Fabrikstrasse 1  
CH-8586 Erlen

Telephone +41 71 649 21 11  
Fax +41 71 649 22 03  
info@lista.com

Lista GmbH  
Germany

Brückenstrasse 1  
D-51702 Bergneustadt

Telephone +49 2261 40 30  
Fax +49 2261 40 32 22  
info.de@lista.com

Lista Austria GmbH  
Austria

Telephone +43 1 291 20  
Fax +43 1 291 204  
info.at@lista.com

Lista (UK) Ltd.  
United Kingdom

Telephone +44 1 908 222 333  
Fax +44 1 908 222 433  
info.uk@lista.com

Lista Italia s.r.l.  
Italy

Telephone +39 02 935 70 196/362  
Fax +39 02 935 70 417  
info.it@lista.com

Lista France  
France

Telephone + 33 4 50 31 71 71  
Fax + 33 4 50 31 71 79  
info.fr@lista.com

Lista Sistemas de  
Almacenaje, S.A.  
Spain

Telephone +34 938 575 927  
info.es@lista.com

# COLOUR YOUR WORKSPACE

Twelve standard colours, six colour combinations, all other colours available. Whether a workbench or drawer cabinet in red, green or violet: LISTA can supply any product, in any colour and colour combination on request. This means that you can design your own individual system with absolute flexibility. All options are possible, from different colours for individual work areas to storage and workspace furnishing in corporate design colours.

In addition to classic standard colours like pale blue, pale grey, pure white or black, you can choose from 12 other predefined colours or simply specify the colours you want. And you can order housings and drawers in different colours. Because when we say flexible, we mean it.

## Standard colours



**.010** Pale blue  
RAL 5012



**.020** Light grey  
RAL 7035



**.030** Reseda green  
RAL 6011



**.040** Capri blue  
RAL 5019



**.050** Metallic grey  
NCS S 6502-B



**.060** Black  
NCS S 9000-N



**.070** Ruby red  
RAL 3003



**.080** Dove grey  
NCS S 4502-B



**.090** Gentian blue  
RAL 5010



**.100** Signal blue  
RAL 5005



**.110** Pure white  
RAL 9010



**.200** Anthracite grey  
RAL 7016



**.514** Pale blue  
RAL 5012  
Light grey  
RAL 7035



**.518** Light grey  
RAL 7035  
Signal blue  
RAL 5005



**.519** Light grey  
RAL 7035  
Metallic grey  
NCS S 6502-B



**.521** Metallic grey  
NCS S 6502-B  
Light grey  
RAL 7035















**.512** Light grey  
RAL 7035  
Ruby red  
RAL 3003



**.522** Ruby red  
RAL 3003  
Metallic grey  
NCS S 6502-B



Other pre-defined colours\*

					
<b>.120</b> Grey aluminium RAL 9007	<b>.130</b> White aluminium RAL 9006	<b>.140</b> Pale grey NCS S 2000-N	<b>.170</b> Ultramarine blue RAL 5002	<b>.180</b> Grey white RAL 9002	<b>.190</b> Sky blue RAL 5015
					
<b>.210</b> Brilliant blue RAL 5007	<b>.220</b> Turquoise blue RAL 5018	<b>.230</b> Pebble grey RAL 7032	<b>.240</b> Flame red RAL 3000	<b>.260</b> Slate grey RAL 7015	<b>.280</b> Orange RAL 2004

\*The other predefined colours are available at extra cost.

**+** The clever measurements system

**The LISTA units**

As a practical grid system, LISTA units enable clear assignment of housing, drawer and partition material. A LISTA unit (U) is 17 mm and is based on the grid system for partitioning drawers. Drawer cabinet housings and the drawers that fit into the housing are based on the same LISTA units, even though they have different dimensions.

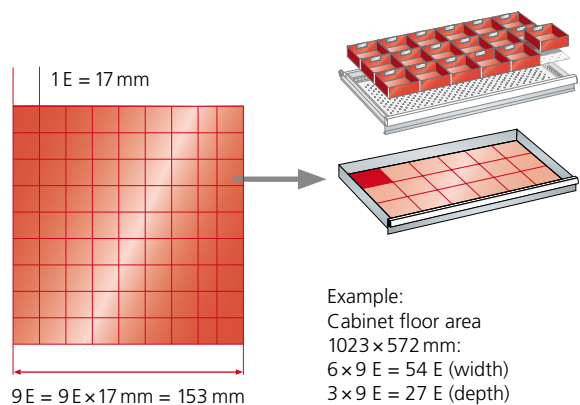

	Depth 27 E				Depth 36 E							
LISTA units	18x27 E	27x27 E	36x27 E	54x27 E	18x36 E	27x36 E	36x36 E	45x36 E	54x36 E	64x36 E	78x36 E	
Cabinet base area mm	411 x 572	564 x 572	717 x 572	1023 x 572	411 x 725	564 x 725	717 x 725	870 x 725	1023 x 725	1193 x 725	1431 x 725	
Drawer usable surface mm	306 x 459	459 x 459	612 x 459	918 x 459	306 x 612	459 x 612	612 x 612	765 x 612	918 x 612	1088 x 612	1326 x 612	



# Explanation of symbols

## Product features



**10-year guarantee**



**Proven safety**



**ESD available**



**Height adjustment**  
in mm



**Drawer load capacity**  
in kg



**Shelf load capacity**  
in kg



**Pull-out shelf load capacity**  
in kg



**Bench load capacity**  
in kg



**Housing load capacity**  
in kg



**Vertical pull-out load capacity**  
in kg

## Locking systems



### KEY Lock

The standard locking system with replaceable cylinders makes it easy to adapt to existing locking systems. The locking system secures all drawers simultaneously.



### CODE Lock

Here the key is replaced by a numeric combination. A simple four to six-digit numeric combination is sufficient to open the drawer cabinets.



### RFID Lock

The LISTA RFID Lock enables automatic and contactless locking through radio frequency identification. It consists of a transponder in the lock and a mobile control unit such as badge or card.



### AUTO Lock

Like RFID Lock, opens and locks automatically however; can also be time-dependent.



## Legal notice

Publisher:

### Lista AG

Fabrikstrasse 1  
CH-8586 Erlen  
info@lista.com  
www.lista.com

This documentation was produced in good faith. The publisher accepts no liability in respect of misprints, errors or omissions. Due to the printing process, colours may deviate from the original colours.

### General terms and conditions

The general terms and conditions and other current information can be found at [www.lista.com](http://www.lista.com). This document is protected by copyright. Any reprinting – even in part – requires written permission from the publisher.



[www.lista.com](http://www.lista.com)